



CATALOGUE



## — GEOTECHNICAL INSTRUMENTS AND STRUCTURAL HEALTH MONITORING

COMPANY PROFILE



## WHO WE ARE

Sisgeo was founded in 1993 inheriting the abilities of SIS Geotecnica, one of the Italian leaders in the geotechnical field during the 70s and the 80s. Over the years, Sisgeo has distinguished itself among the international excellences in the manufacturing and design of high-precision measuring instruments. Experience is the solid foundation from which we start every day to develop our products and services with a strong focus on continuous innovation and attention to the Customers' present and future needs.

1



*During the years, Sisgeo has become an internationally recognized brand for quality, reliability and innovation.*

## ROOTED IN ITALY CONNECTED WORLDWIDE

In June 2025, Sisgeo became part of the Eddyfi Technologies family, joining Senceive and Sensor Networks, within the Remote Monitoring Solutions (RMS) product line. This means a significant expansion of the range of structural and advanced wireless connectivity solutions available to our customers.

Eddyfi Technologies is a global leader in advanced inspection and monitoring solutions. As part of the Previa group, Eddyfi Technologies offers cutting-edge instruments, sensors, software, and robotics used in over 110 countries across civil infrastructure, energy, aerospace, mining, and transportation sectors.

1 VK40 vibrating wire strain gauges

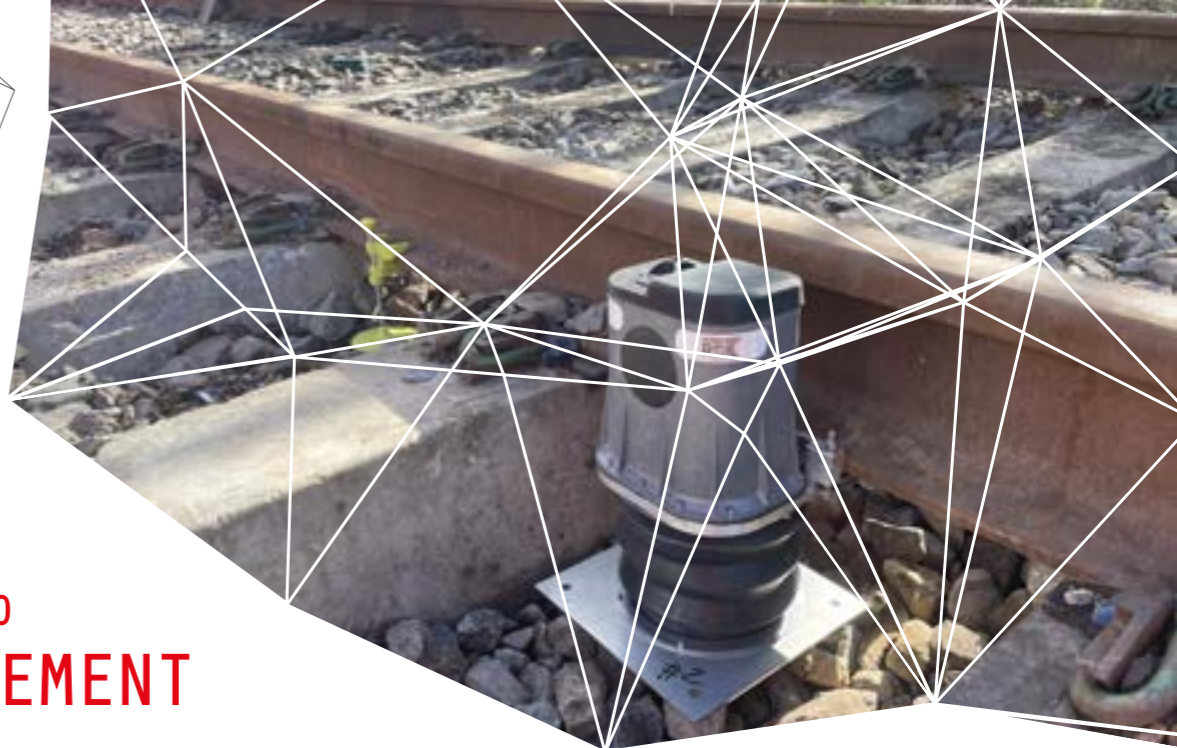

## INCLINED TO IMPROVEMENT

*A natural inclination for geotechnical and structural monitoring instrumentation*

Sisgeo is a manufacturer of geotechnical and structural monitoring instrumentation, and global leader in the production of cutting-edge technologies applied to inclinometers. We design, produce, and install a wide range of high precision instruments conceived to provide added value to geotechnical and structural engineering in any possible application.

Creating, designing, manufacturing: this is what we do to bring about continuous improvement. We listen to the earth through our instruments, and we respect it by applying production processes designed to reduce our environmental impact with the view to pursue human-centric progress and to allow everyone to shape their own future.

2

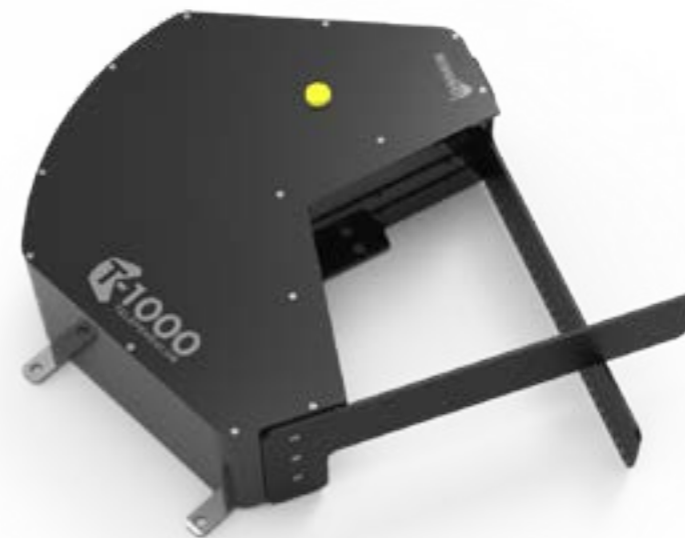

2 T-1000 telependulum

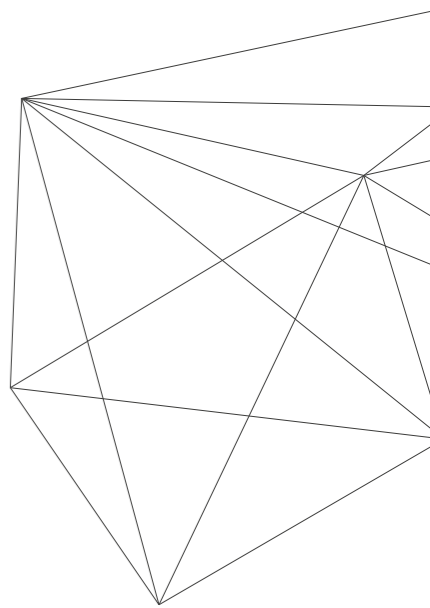

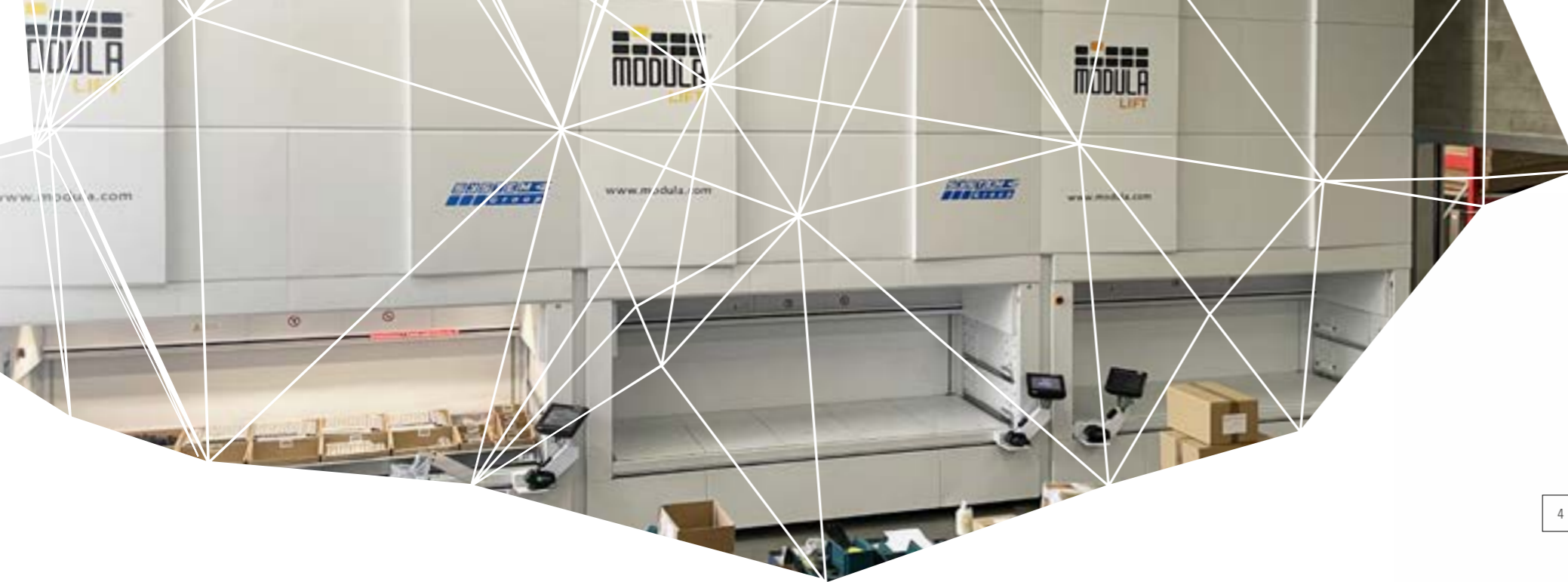

— FROM ITALY TO THE WORLD  
**DRIVING INNOVATION  
 IN GEOTECHNICAL MONITORING**



3

Since 1993, Sisgeo has brought Italian expertise in engineering, technology, and precision to the global geotechnical market. From our headquarters in Masate, we manage every step of production, ensuring reliable and high-quality solutions.

Thanks to our international subsidiaries and global network, we deliver tailored systems to meet the specific needs of each market.

Today, we're proud to be part of Eddyfi Technologies, joining Senceive and Sensor Networks, within the Remote Monitoring Solutions (RMS) group. This step expands our range with industry-leading wireless technologies and a fully integrated monitoring range.

United with Senceive, you will now get coverage, from surface to subsurface, to tackle your most complex structural and geotechnical challenges.

3 MD-PROFILE inclinometer

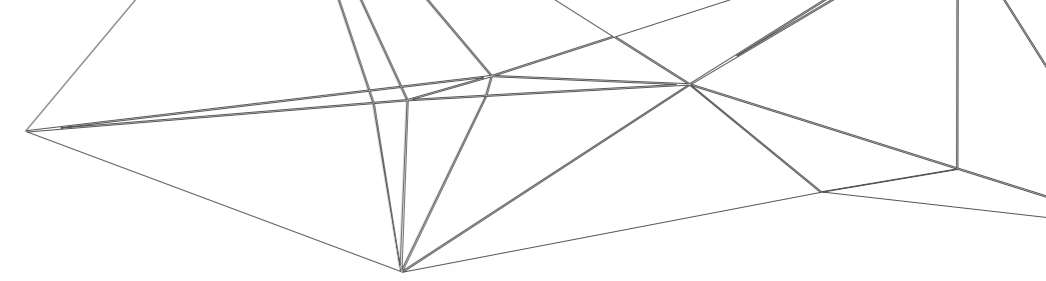

4

— *Every day, we rely on our expertise and experience to develop our products and services and to keep innovating and forecasting future trends.*

— **100% RELIABLE  
 QUALITY**

Sisgeo considers manufacturing procedures, Client feedback and good organization to be the fundamental concepts to achieve quality. In 1997 Sisgeo obtained the ISO 9001 Certification and since then, the constant and continuous application of our Quality System, widespread at all levels of the company, is a source of improvement, evolution and growth.

4 B.R.A.IN system reel

COMPANY WITH  
 QUALITY SYSTEM  
 CERTIFIED BY DNV  
 ISO 9001

## ALWAYS AHEAD OF TIMES

*Experience is the solid foundation from which we start to develop our products and our services with a constant focus on continuous innovation and attention to the sector's future needs*



Research and development are a distinctive trait of Sisgeo. A consistent commitment that is reflected both in the design of new and innovative products and in the continuous optimization of the production process, in order to always keep our range of instruments technologically up to date and make it more comprehensive, flexible and competitive.

We design, manufacture and provide a wide range of high-precision measuring instruments covering the various monitoring application in structural and geotechnical engineering:

- Piezometers
- Inclinometers and tiltmeters
- Railway monitoring instrumentation
- Extensometers
- Crackmeters and jointmeters
- Pressure and load cells
- Settlement gauges
- Strain gauges and thermometers
- Pendulum systems
- Readouts and dataloggers

5 H-LEVEL Liquid Level System



*We believe our continue interaction with customers and consultants is essential to increase our experience and stimulate our creativity.*



## THE RIGHT TECHNOLOGY FOR EVERY MONITORING NEED

Plan, design and manufacture are our ways of improving and simplifying our customers' work. Being able to take care of the entire production process internally, allows us to offer advanced instrumentation that benefits from the expertise of a highly motivated team, capable of rising up to the latest challenges by applying innovation, know-how, cutting-edge design and a deep knowledge of civil engineering and instrumentation applied to geology.

6 S543 360° digital mems tiltmeter

# GEOTECHNICAL INSTRUMENTS AND STRUCTURAL HEALTH MONITORING

## — PIEZOMETERS

Vibrating wire piezometers	13
Titanium piezometers	13
Piezo resistive piezometers	13
Drive-in piezometers	15
Removable pressure transducers	15
Multipoint piezometer string	15
Vented pressure transducers	17
Staff gauges	17
Seepage measurements weir monitoring	17
Water level indicators (WLI)	19
Standpipe and Casagrande piezometers	19

## — INCLINOMETERS

Inclinometer casings	21
Easy-lock and quick-joint ABS casings	21
Combined inclinometer/settlement measurement	21
B.R.A.IN inclinometer system	23
Mems inclinometer and spiral probe	23
Klion analysis software	23
MEMS in-place inclinometer	25
360° MD-Profile IPI array	25
360° LT-Inclibus array	25
BH-Profile in-place inclinometer	27
Horizontal in-place inclinometer	27
Mems analogue tilt meters	29
360° digital mems tiltmeter	29
Tilt beam sensors	29
Tilli portable tiltmeter	31
Submersible MEMS tiltmeter	31

## — SETTLEMENT GAUGES

H-Level liquid level system	33
Multipoint settlement system	33
Prisms and targets	33
T-Rex incremental extensometer	35
DEX in-place extensometer	35
DEX-S 3D in-place extenso-inclinometer	35
Fixed extensometer	37
Magnet extensometer (BRS)	37

## — PRESSURE & LOAD CELLS

Earth pressure cells	39
Hydraulic pressure cells	39
Hydraulic anchor load cells	41
Electric anchor load cells	41
Electro-hydraulic load cells	41

## — EXTENSOMETERS & JOINTMETERS

Embankment extensometers	43
Embedment jointmeters	43
Multipoint rod extensometer (MPBX)	45
Displacement transducers for MPBX	45
MEXID extensometer	45
Wire crackmeter and deformer	47
Electrical and vibrating wire crackmeters	47
3D Mechanical crackmeter	47

## — STRAIN-GAUGES & THERMOMETERS

Vibrating wire strain-gauges	49
Spot weldable strain gauges	49
Embedment thermometers	51
Temperature strings	51

## — PENDULUMS & READOUT

Direct and inverted pendulums	53
T-1000 Telependulum	53
Optical pendulum readout	53

## — READOUTS, DATALOGGERS & ACCESSORIES

MIND readout	55
MIND App main features	55
OMNIAlog datalogger	57
OMNIAlog cabinets	57
Remote multiplexers	57
Senceive Sensor Interface Range	59
Readout accessories and spare parts	59
Signal and multicore cables	59

## — MONITORING SOLUTIONS FOR RAILWAY INFRASTRUCTURES

SISGEO RAIL®	61
Wireless FLX-RAIL® rail swing monitoring	61
RDS Railway Deformation System	61



# PIEZOMETERS

\_GROUND WATER LEVEL

\_PORE WATER PRESSURE

\_EARTHFILL DAMS  
AND EMBANKMENTS

\_UP-LIFT PRESSURE  
IN DAM FOUNDATIONS

\_SEEPAGE MONITORING

\_WATER PRESSURE BEHIND  
TUNNEL LININGS

\_POTENTIAL LANDSLIDES

\_DEWATERING AND PUMP TESTS

\_FOUNDATIONS  
AND DIAPHRAGM WALLS



## VIBRATING WIRE PIEZOMETERS

VW piezometers consist of a vibrating wire sensing element enclosed in a protective stainless steel housing a filter tip. VW piezometers offer an excellent long-term reliability as a result from the use of the latest developments in vibrating wire technology. Heavy duty model PK45 is recommended for use in earthfill dams with armoured cable.

### STANDARD VW PIEZOMETERS

MODEL PK20A	with HAE value filter unit
MODEL PK20S	with LAE value filter unit
Standard ranges	0-170 kPa up to 0-5.0 MPa 0-25 psi up to 0-725 ps
Sensitivity	0.025% FS
Accuracy <sup>(1)</sup>	
Lin. MPE	< ±0.4% FS
Pol. MPE	< ±0.25% FS
Temp. operating range	-20°C +80°C
Filter unit features:	
- HAE	0.25 µ ceramic
- LAE	40 µ synthesized s/steel 50 µ synthesized PE (Vyon®)
Diameter/length	20 mm/177 mm

### HEAVY DUTY PIEZOMETERS

MODEL PK45A	with HAE value filter unit
MODEL PK45S	with LAE value filter unit
Standard ranges	0-170 kPa up to 0-5.0 MPa - 5.0 MPa 0-25 psi up to 0-725 psi
Sensitivity	0.025% FS
Accuracy <sup>(1)</sup>	
Lin. MPE	< ±0.4% FS
Pol. MPE	< ±0.25% FS
Temp. operating range	-20°C +80°C
Filter unit features:	
- HAE ceramic	40 µ synthesized s/steel
- LAE (100 kPa)	50 µ synthesized PE (Vyon®)
Diameter / length	27 mm / 201 mm

(1) MPE is the Maximum Permitted Error on the measuring range (FSR). In the Calibration Report, the accuracies of the gauge are calculated using both linear regression (≤ Lin. MPE) and polynomial correction (≤ Pol. MPE)

SISGEO.COM

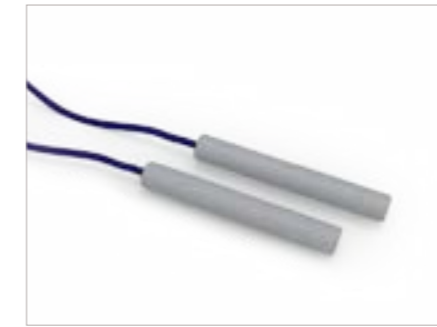

## TITANIUM PIEZOMETERS

Titanium piezometers have been specifically designed for installation in high corrosive environments and aggressive soils. All the exposed surfaces are made of titanium and the ceramic membrane (diaphragm) is chemically inert. Titanium piezometers are recommended in landfills, brackish groundwaters and aggressive mine tailings.

### TECHNICAL SPECIFICATIONS

MODEL P235TI	with HAE or LAE value filter
Standard ranges	200, 500 kPa, 1.0, 2.0 MPa
Signal output	4-20 mA current loop
Sensitivity	0.01% FS
Total Accuracy <sup>(2)</sup>	< ±0.20% FS (for 200 kPa FS) < ±0.15% FS (all other FS)
Electric supply	12 - 24 V DC
Temp. Operating range	-20°C +80°C
Filter unit characteristics:	
- HAE	0.25 µ ceramic stone
- LAE (100 kPa)	40 µ synthesized PE (Vyon®)
Diameter / length	27 mm/193 mm

Sisgeo tests have verified that titanium piezometers do not have functionality or corrosion problems after one year in a solution with pH = 1 and temperature 20 °C.

### OPF01SAT000 SATURATION DEVICE

The filter saturation is a decisive factor for a successful installation of embedded piezometers. Sisgeo provides a device for field use for the saturation of the HAE value filter (ceramic stone). It consists of a stainless steel pump with manometer and a threaded port to fit the filter unit.



(2) including linearity, hysteresis and repeatability, calculated with 3rd degree polynomial



## PIEZO-RESISTIVE PIEZOMETERS

Piezo-resistive piezometers and pressure transducers combine mechanical robustness, capacity to withstand aggressive environments and performance reliability. Piezo-resistive piezometers are suitable for dynamic measurements of water level or pore water pressure, and when data acquisition system is not compatible with vibrating wire technology

### TECHNICAL SPECIFICATIONS

MODEL P235S1	with HAE value filter
MODEL P235S4	with LAE value filter
Standard ranges	200, 500 kPa 1.0, 2.0, 5.0 MPa
Signal output	4-20 mA current loop
Sensitivity	0.01% FS
Total accuracy <sup>(2)</sup>	< ±0.25% FS
Lin. MPE	< ±0.20% FS (for 100 and 200 kPa FS)
Pol. MPE	< ±0.15% FS (all other FS)
Temp. Operating range	-20°C +80°C
Filter unit characteristics:	
- HAE filter	0.25 µ ceramic stone
- LAE (100 kPa)	40 µ synthesized s/steel 50 µ synthesized PE
Diameter / length	27 mm / 193 mm

### ACCESSORIES

OPXPUMP0020	Pneumatic hand pump for checking the pore pressure transducers calibration.
OPX20CHECK0	Tools for OPXPUMP0020 to allow PK20 connection

### SPARE PARTS

OPF20D16000	HAE filter stone for PK20
OPF20D2000P	LAE Vyon® filter for PK20
OPF20D20000	LAE s/steel filter for PK20
OPF01D16000	HAE filter stone for PK45
OPF40D2000P	LAE Vyon® filter for PK45
OPF40D20000	LAE s/steel filter for PK45



Project:  
Saint Helena Airport,  
Saint Helena Island

# PIEZOMETERS

\_GROUND WATER LEVEL

\_PORE WATER PRESSURE

\_EARTH FILL DAMS  
AND EMBANKMENTS

\_UP-LIFT PRESSURE  
IN DAM FOUNDATIONS

\_SEEPAGE MONITORING

\_WATER PRESSURE BEHIND  
TUNNEL LININGS

\_POTENTIAL LANDSLIDES

\_DEWATERING AND PUMP TESTS

\_FOUNDATIONS  
AND DIAPHRAGM WALLS



## DRIVE-IN PIEZOMETERS

Drive-in piezometers have the transducer mounted inside a cylindrical body with a conical nose and housing for the push-in rod. The large diameter of the conical nose prevents any chance of overpressure during the installation into the soil (push-in). The push-in rod allows installation using conventional cone penetrometer or drilling rod with adapters.

### AVAILABLE MODELS

MODEL PK45I	VIBRATING WIRE
Standard ranges	0 - 350 kPa, 0 - 2.0 MPa
Sensitivity	0.025% FS
Total Accuracy <sup>(1)</sup>	< ±0.25% FS
Temp. operating range	-20°C +80°C

MODEL P235I	PIEZO-RESISTIVE
Standard ranges	0 - 200 kPa, 0 - 5.0 MPa
Signal output	4-20 mA current loop
Sensitivity	0.01% FS
Total Accuracy <sup>(1)</sup>	< ±0.20% FS (for 200 kPa FS) < ±0.15% FS (all other FS)

Temp. operating range	-20 to +80 °C
Filter unit	Ceramic HAE filter. Filter on request should be saturated at factory.
Diameter / length	27 mm / 256 mm

### ACCESSORIES

SPUSH - IN ROD OP235I ROD00	Stainless steel push-in rod, 430mm long. One end fits the piezometer and the other end couples to 1" pipe (gas thread). It could be supplied without thread for welding CPT rods.
--------------------------------	---

FILTER SATURATION DEVICE OPF01SAT000	Stainless steel pump for saturating HAE ceramic filters. Includes pump, 10 bar pressure gauge, and a threaded connection for the filters.
--	---

(1) Including linearity, hysteresis and repeatability, calculated with 3rd degree polynomial

SISGEO.COM

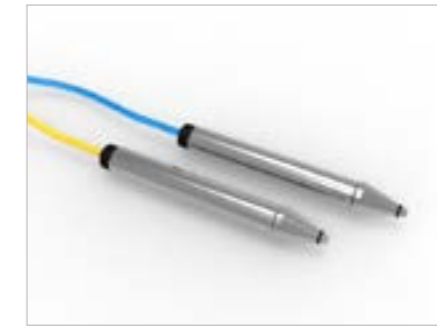

## REMOVABLE PRESSURE TRANSDUCERS

The removable pressure transducers are installed in Casagrande piezometers with the P101 porous filter unit which mates to the conical tip of the transducer housing. The removable pressure transducers are specially designed for long-term monitoring of soil pore pressure. They can be removed for calibration checks, maintenance or re-used in other boreholes.

### AVAILABLE MODELS

MODEL PK45C2	VW range 0-200 kPa
MODEL PK45C5	VW range 0-500 kPa
Signal output	frequency (VW), resistance (T)
Sensitivity	0.025% FS
Total Accuracy <sup>(1)</sup>	< ±0.25% FS
Temp. operating range	-20°C +80°C
Diameter / length	27 mm body - 30 mm head / 230 mm

MODEL P252C00200	PIEZO-RESISTIVE range 0-200 kPa
MODEL P252C00500	PIEZO-RESISTIVE range 0-500 kPa
Signal output	4-20 mA current loop
Sensitivity	0.01% FS
Total accuracy	< ±0.20% FS for P252C00200 < ±0.15% FS for P252C00500
Temp. operating range	-10°C +55°C
Diameter / length	27-30 mm / 230 mm

OP101002000	STANDPIPE FILTER UNIT, 200 MM
-------------	-------------------------------

### INSTALLATION DETAIL

The tip of the removable pressure transducer is designed to mate with the conical port of the P101 Casagrande filter. A seal is maintained via an o-ring in the tip and ballasting weights slipped onto the signal cable. A small orifice in the tip allows pore-water pressure to act on the diaphragm inside the pressure transducer.

The P101 Casagrande filter tip and riser pipe are installed in the normal way. The transducer, with brass ballasting weights, is lowered to mate with the port in the P101 filter. The transducer can be removed for calibration checks or replacement.

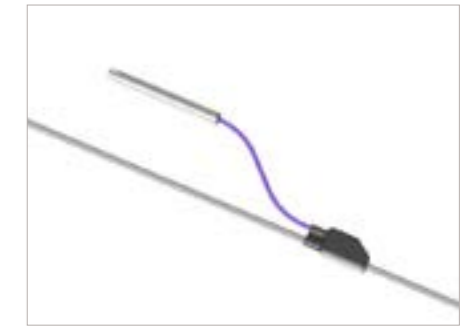
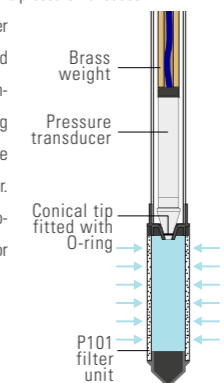

## MULTIPOINT PIEZOMETER STRING

Multi-point piezometer consists of a string of vibrating wire piezometers connected by single multicore cable, ideal when more than one piezometer is requested at various depth in the same borehole. A string of multipoint piezometer is composed by a multicore cable with connected at desired depth a PK20 vibrating wire piezometer.

### TECHNICAL SPECIFICATIONS

Full scales (FS)	0-350 kPa up to 0-3.5 MPa
Signal output	frequency (VW), resistance (T)
Sensitivity	0.025% FS
Accuracy <sup>(2)</sup>	
Lin. MPE	< ±0.4% FS
Pol. MPE	< ±0.25% FS
Temp. operating range	-20°C +80°C
Filter unit	40/50 µm stainless steel or Vyon®

### SIGNAL CABLES

OWE1160LSZH	LSZH Multicore cable for up to 4 multipoint piezometers, with 8 twisted-pair
OWE1160PVC	LSZH Multicore cable for up to 8 multipoint piezometers, with 16 twisted-pair

### FULLY GROUTED INSTALLATION METHOD

The fully-grouted method is gaining popularity because it is a simple, economical and accurate procedure to monitor pore water pressure in the field. The working principle is based on the idea that a diaphragm piezometer embedded directly in a large mass of low permeability cement-bentonite grout should respond instantly to a pore water pressure change. Grout mixes (water-cement-bentonite) are controlled to give the desired strength of the set grout. Appropriate permeability of the cement-bentonite grout is crucial for the success of the fully-grouted method. For more details, refer to: "Piezometers in Fully Grouted Boreholes" by Mikkelsen and Green, FMGM proceedings Oslo 2003.

(2) MPE is the Maximum Permitted Error on the measuring range (FSR). In the Calibration Report, the accuracies of the gauge are calculated using both linear regression ( $\leq$  Lin. MPE) and polynomial correction ( $\leq$  Pol. MPE)



Project:  
Ouldjet Mellegue Dam  
Algeria

# PIEZOMETERS

- \_ GROUND WATER LEVEL
- \_ PORE WATER PRESSURE
- \_ EARTH FILL DAMS AND EMBANKMENTS
- \_ UP-LIFT PRESSURE IN DAM FOUNDATIONS
- \_ SEEPAGE MONITORING
- \_ WATER PRESSURE BEHIND TUNNEL LININGS
- \_ POTENTIAL LANDSLIDES
- \_ DEWATERING AND PUMP TESTS
- \_ FOUNDATIONS AND DIAPHRAGM WALLS



## VENTED PRESSURE TRANSDUCERS

The model P252R is a level transducer equipped with a relative vented piezoresistive pressure sensor which provides automatic compensation of the barometric changes. This transducer provides ground water table monitoring in standpipe and Casagrande piezometers.

### TECHNICAL SPECIFICATIONS

Standard ranges	100, 200, 500 kPa, 1.0 MPa
Signal output	4-20 mA (mV/V on request)
Sensitivity	0.01% FS
Total Accuracy <sup>(1)</sup>	< ±0.15% FS
Power supply	12 - 24 V DC
Overpressure	1.3 x FS
Thermal zero shift	0.00025% FS / °C
Temp. Operating range	-10°C +55°C
Filter unit	synthesized stainless steel or Vyon®
Body material	Stainless steel
Diameter / length	27 mm / 191,5 mm
Signal cable	OWE203KEQZH (For 4-20mA output) OWE205KEOPV (For mV/V output)

### ACCESSORIES

VENTED SUPPORT HEAD OP200CH1000	Protective lockable cap for standpipe piezometers with support for P252R transducers, data plate and survey pin.
JUNCTION BOX WITH OVP OEPDP002W00	Vented junction box with 3 levels of overvoltage protection, suitable for 2-wire signal cables.

(1) Including linearity, hysteresis and repeatability, calculated with 3rd degree polynomial



## STAFF GAUGES

The staff gauges are used for a quick visual indication of the surface level in reservoirs, rivers, streams and open channels. These environmentally rugged iron gauges are finished with porcelain enamel to ensure easy reading and resist to rust or discoloration. Each gauge is accurately graduated and has holes for easy fastening to walls, piers and other structures.

### STANDARD COMPONENTS

STAFF GAUGE OHIDR1000S0	Hydrometric rod 1 meter long, white background and black graphics. It is divided into centimeters with each decimeter numbered. Rods for any elevation may be assembled.
FIGURE PLATE OHIDR1310P0	Number plate with 3 figures which represent elevation. The three black figures are printed on white porcelain enameled plate. Using a combination of these figures any elevation may be represented.

### SPECIAL PARTS

CUSTOMIZED GAUGES	Customized gauges are designed on Client's request. Specially manufactured for inclined installation or with special colors and graphics. Inclined staff gauges can be installed onto inclined surface such as upstream face of dams or concrete lined irrigation channels. Mounted flush on the sloped sides, these staff gauges give a direct reading of the vertical stage height.
-------------------	---

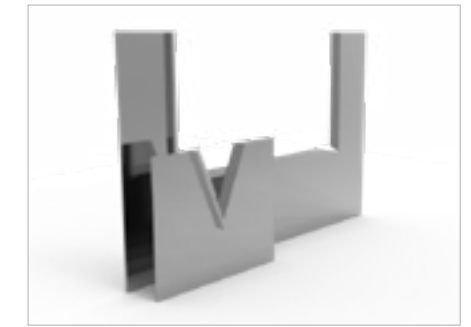

## SEEPAGE MEASUREMENTS WEIR MONITORING

V-notch weirs are typically installed in open channels such as streams to determine discharge (flowrate). The basic principle is that the discharge is directly related to the water depth above the bottom of the "V". Leakage measurement is one of the most important indicators of the overall performance of dikes and dams.

### V-NOTCH WEIRS

The purpose of the weir is to transform the instantaneous flow values into the pressure/level by means of specific measuring equipment. V-notch weirs are preferred for low discharges as the head above the weir crest is more sensitive to changes in flow compared to rectangular weirs.

0QV45LS1000	10 litre/sec, V-angle 45°
0QV60LS2000	20 litre/sec, V-angle 60°
0QV90LS5060	50 litre/sec, V-angle 90°
0QV90LS5000	50 litre/sec, rectangular

### WATER LEVEL TRANSDUCER

The V-notch water level transducer consists of a highly sensitive relative pressure sensor with 2 m vented cable and junction box with 3 levels of overvoltage protection.

0QVML0500EX	Level transducer, range 0-500mm
0QVML1000EX	Level transducer, range 0-1000mm
Transducer type	Ceramic capacitive pressure transducer
Measuring range	500 mm or 1000 mm of water column
Total accuracy <sup>(1)</sup>	< ±0.2% FS
Output signal	4-20 mA current loop
Power supply	15 - 24 V DC
Operating temperature	-20°C + 80°C

### ACCESSORIES AND SPARE PARTS

0QVHI030000	Staff gauge for V-notch 300 mm long, millimetre division
0QVHI050000	Staff gauge for V-notch 500 mm long, millimetre division
0P252Q000000	Spare pressure transducer 500 or 1000 mm H <sub>2</sub> O
0EPDP002W00	Spare junction box with OVP

# PIEZOMETERS



- \_GROUND WATER LEVEL
- \_PORE WATER PRESSURE
- \_EARTHFILL DAMS AND EMBANKMENTS
- \_UP-LIFT PRESSURE IN DAM FOUNDATIONS
- \_SEEPAGE MONITORING
- \_WATER PRESSURE BEHIND TUNNEL LININGS
- \_POTENTIAL LANDSLIDES
- \_DEWATERING AND PUMP TESTS
- \_FOUNDATIONS AND DIAPHRAGM WALLS



## WATER LEVEL INDICATORS (WLI)

The WLI or Dipmeters are used to measure the water level in standpipes piezometers. WLI is a battery powered portable device equipped with a stainless steel sensor probe connected to a graduated flat cable rolled up on a hand reel containing audio and visual indicators, and battery. The model C112T includes a digital indicator for temperature readings.

### AVAILABLE MODELS

MODEL C112	flat cable with marks at every millimetre
Probe	water level detector
Cable lengths	30, 50, 100 m 150, 200, 300, 400, 500 m
Probe diameter	16 mm (suitable for tube $\geq \frac{3}{4}$ " )
Battery	1 x 9V DC disposable
MODEL C112T	flat cable with marks at every millimetre
Probe	water level detector and temperature sensor
Cable lengths	30, 50, 100 m 150, 200, 300, 400, 500 m
Reel diameter	260 mm, 320 mm, 420 mm
Probe diameter	16 mm (suitable for tube $\geq \frac{3}{4}$ " )
Display	3.5 LCD (only for C112T)
Battery	2 x 9V DC disposable

### PROBE SPARE PARTS



OC112KITR00	Probe spare set for the model C112 including sensor probe weights and epoxy.
OC112TKITR0	Probe spare set for the model C112T including sensor probe weights and epoxy.



## STANDPIPE AND CASAGRANDE PIEZOMETERS

Standpipe and Casagrande piezometers are open piezometers widely used to monitor piezometric water levels in vertical boreholes. Open piezometer consists of two parts: a porous tip and a riser pipe which continues upwards out of the top of the borehole. The porous tips are located within a sand filter zone and a bentonite seal is required between the sand filter zone and the backfill.

### AVAILABLE MODELS

P101		Casagrande/standpipe 40 $\mu$ porous tip Tube connection: 1 x 1" $\frac{1}{2}$ Length: 200 mm Outer diameter: 61.5 mm
P112A		Casagrande 40 $\mu$ porous tip Tube connection: 1 x 1" $\frac{1}{2}$ / 1 x $\frac{1}{2}$ " Length: 200 mm Outer diameter: 80 mm

### ACCESSORIES

LOCKABLE CAP OP100CH1000	Equipped with an identification plate and a topographic pin, the lockable cap ensures protection at the top end of Casagrande and standpipe piezometers.
TRANSDUCER SUPPORT HEAD OP100CH2000	It is equipped with an identification plate, a topographic pin, a lockable cap and a hanging system for pressure transducers.
PVC BOTTOM CAP <sup>(1)</sup> OTPVC000000	Bottom cap for standpipe piezometer with slotted tube filter. Available for $\frac{1}{2}$ ", 1", 1 $\frac{1}{2}$ ", 2" and 3" tubes.
GEOTEXTILE FILTER <sup>(1)</sup> 1000TNT000	Special sock made by geotextile placed around slotted PVC tubes to prevent incoming of sand.

## EXAMPLE OF CASAGRANDE PIEZOMETERS

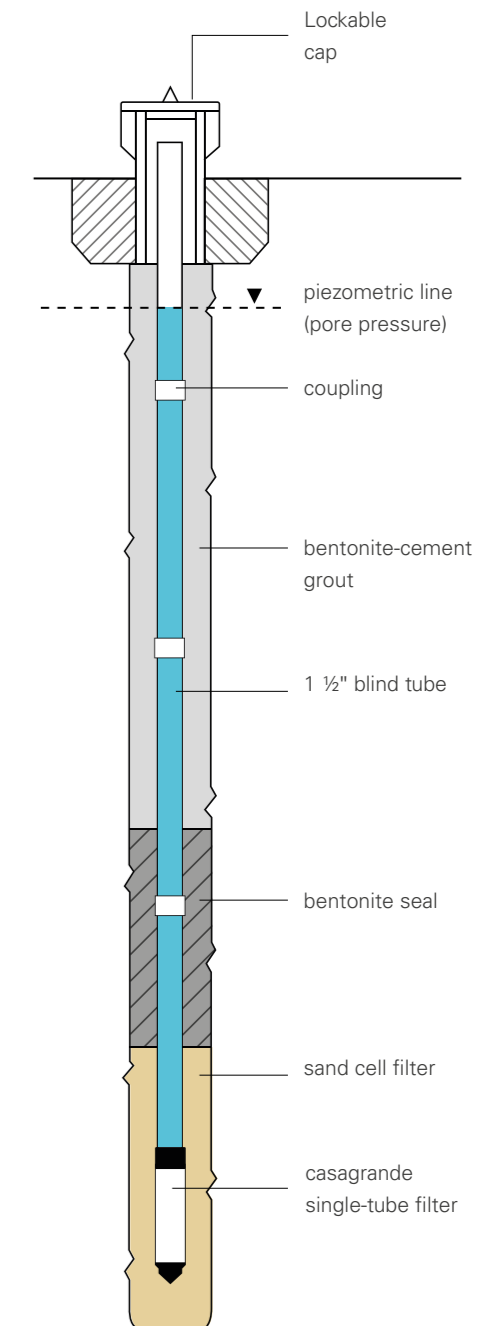

# INCLINOMETERS

- \_LANDSLIDES
- \_DAMS
- \_UNSTABLE SLOPES
- \_PILES
- \_DIAPHRAGM WALLS
- \_TUNNELING
- \_DEEP EXCAVATIONS
- \_BRIDGES AND VIADUCTS
- \_EMBANKMENTS

Project:  
Ituango HPP  
Colombia



## INCLINOMETER CASINGS

Aluminium or ABS inclinometer casings are special grooved tubes, generally installed into a borehole, and used in conjunction with an inclinometer system to determine sub-surface ground or horizontal soil movements. Standard inclinometer casings assembly require drill, rivets, glue and tape.

### STANDARD ABS INCLINOMETERS

Model	S13100603M	S13100610F
Material	ABS plastic	ABS plastic
Tube outer diameter	71 mm (2.8")	77 mm (3.0")
Tube inner diameter	60 mm (2.4")	67 mm (2.6")
Tube groove inner diameter	65 mm (2.6")	71.5 mm (2.8")
Thickness	3.75 mm (0.15")	5 mm (0.2")
Casing length	3 m	10 ft
Weight	0.7 kg/m	0.21 kg/ft
Spiral	<0.6° / 3 m	<0.6° / 10 ft
Suggested borehole drilling diameter	101 mm (4")	-



## EASY LOCK AND QUICK-JOINT ABS CASINGS

The Easy Lock inclinometer casing is a grooved tube machined at the end to have a self-aligning and fast junction. The QJ Quick-Joint casing consists of sections with built-in couplings that snap together. Both models are produced from high-quality virgin ABS and have O-rings ensure that the joint is grout proof.

### OS143107000 EASY LOCK INCLIN. CASING

Material	ABS plastic
Outer diameter	70 mm (2.75")
Coupling outer diameter	76 mm (3.00")
Inner diameter	58 mm (2.32")
Groove inner diam.	63.5 mm (2.5")
Overall casing length	3055 mm (casing + coupling)
Overall casing weight	3.6 kg (casing + coupling)
Spiral <sup>(1)</sup>	< 0.2° / m
Collapse test <sup>(2)</sup>	15 bar
HDT test ISO 75 <sup>(3)</sup>	+83°C (181 °F)

### OS151107000 QJ INCLINOMETER CASING

Material	ABS (Acrylonitrile Butadiene Styrene)
Tube outer diameter	70 mm (2.75")
Tube inner diameter	59 mm (2.32")
Overall section length	3100 mm (500 mm for OS151MT0700)
Overall diameter	84 mm
Colour	white / red
Spiral <sup>(1)</sup>	<0.6° / 3 m
Collapse test <sup>(2)</sup>	15 bar
Temperature (max 1 hour)	+80°C C (176 °F)

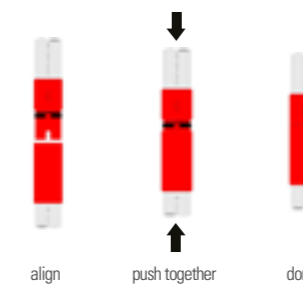

(1) During manufacturing particular attention is paid to minimise the spiral of the casing grooves and to machine the aligning key for casing junction with self-aligning couplings. Spiral value is verified connecting 10 inclinometer casings of a batch and verifying the spiralling between the two ends. (2) Test was performed in a water pressure chamber with empty casing sealed at the two ends. (3) Heat deflection temperature is defined as the temperature at which a standard test bar deflects a specified distance under a load of 1.80 MPa



## COMBINED INCLINOMETER AND SETTLEMENT MEASUREMENT

Inclinometer and settlement measurements may be combined in the same borehole or in an embankment. The system consists of an ABS inclinometer casing equipped with telescopic couplings and settlement rings with permanent magnets. Settlement rings are available with spring spiders for installation in borehole or with round plates for embankments.

### ACCESSORIES FOR EASY LOCK CASING

OS143ST0000	TELESCOPIC SECTION 3 meter section with 70 or 150 mm gap
OS143AF6000	SPIDER MAGNET RING Used in borehole with spring legs
OS143AR6000	EMBANKMENT MAGNET RING Used in fill with plate, OD 300 mm

### ACCESSORIES FOR QJ CASING

OS151MT0700	QJ TELESCOPIC COUPLING 500 mm long with 75 mm gap
OS151DR7000	QJ DATUM REFERENCE SECTION B Bottom datum point in borehole for inclino-settlement column

## MEASUREMENTS

Manual readings are carried out lowering inside the casing:

- the inclinometer probe for monitoring the horizontal movements;
- the portable magnet extensometer readout model C121 with millimetre tape for detecting settlements.

# INCLINOMETERS

- \_LANDSLIDES
- \_DAMS
- \_UNSTABLE SLOPES
- \_PILES
- \_DIAPHRAGM WALLS
- \_TUNNELING
- \_DEEP EXCAVATIONS
- \_BRIDGES AND VIADUCTS
- \_EMBANKMENTS

Project:  
Lyon-Turin high speed railway tunnel  
Border France-Italy



## B.R.A.IN INCLINOMETER SYSTEM

B.R.A.IN (Borehole Readout Array for INclinometers) system is mainly composed by digital inclinometer probe, bluetooth reel with control cable and B.R.A.IN APP compatible with Android and iOS devices. The intuitive B.R.A.IN APP allows the user to manage the inclinometer and spiral meter surveys and immediately share the readings with the most popular APP installed on the device.

### VERTICAL SYSTEMS PERFORMANCES

Readout value	20000 sin alpha (other values available on request)
System resolution:	
- with 500 mm gauge length	0.011 mm / 500 mm
- with 1000 mm	0.023 mm / 1000 mm
- with 2 ft gauge length	±0.0005 in/2 ft
Repeatability (precision) <sup>1</sup>	
- with 500 mm gauge length	± 1.5 mm / 30 m
- with 1000 mm	± 2.0 mm / 30 m
- with 2 ft gauge length	±0.079 in/100 ft

### HORIZONTAL SYSTEMS PERFORMANCES

Readout value	20000 sin alpha (other values available on request)
System resolution:	
with 500 mm gauge length	0.011 mm / 500 mm
with 1000 mm gauge length	0.023 mm / 1000 mm
Repeatability (precision) <sup>1</sup>	
with 500 mm gauge length	± 7.0 mm / 30 m
with 1000 mm gauge length	± 10.0 mm / 30 m

(1) As for ISO 18674-3, this is the "difference between the cumulated displacements of a measuring point relative to a reference point 30 m apart, when repeatedly carrying out the survey under repeatability conditions."

### B.R.A.IN APP

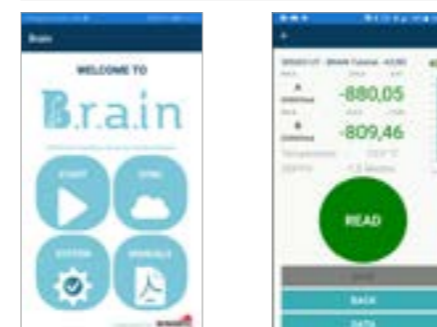

Two example of screenshot

SISGEO.COM



## MEMS INCLINOMETER AND SPIRAL PROBES

The vertical and horizontal inclinometer probe is composed by a high performance MEMS sensors and a digitalizing electronic board, mounded inside a stainless steel body with 4 spring-loaded wheels and a waterproof connector. The digital spiral meter is used to define the azimuth of the installed inclinometer casing in order to verify that the casing has been installed correctly.

### OS242DV3000 VERTICAL PROBE

Measuring range	±30°
Sensor type	biaxial digital MEMS
Probe accuracy MPE <sup>(1)</sup>	±0.01% FS
Temp. operating range	-30°C to +70°C (-22°F to +158°F)
Body material and diam.	stainless steel, 28 mm
Gauge length	500mm, 1000mm, 2 ft
Wheels	pair of wheels (Ø 32 mm / 1.26 in) mounted on long-life sealed ball bearings
IP rate	IP68 up to 2.0 MPa

### OS241DH3000 HORIZONTAL PROBE

Measuring range	±30°
Sensor type	uniaxial digital MEMS
Probe accuracy <sup>(1)</sup>	±0.01% FS
Temp. operating range	-30°C to +70°C
Body material and diam.	stainless steel, 28 mm
Gauge length	500mm, 1000mm
Wheels	2 fixed wheels and 2 spring-loaded wheels
IP rate	IP68 up to 2.0 MPa

### OS30PR12D00 DIGITAL SPIRAL PROBE

Measuring range	±5° over wheels base (1000 mm)
Sensor type	rotary contactless potentiometer (magneto-resistive)
Resolution	0.001 FS
Repeatability	±0.01% FS
Stability	± 0.025% FS
Accuracy	< ±0.5% FS
Power supply	± 2.5 V DC
Diameter	28 mm
Length	1250 mm (without connector)
Wheel base	1000 mm
Connector	watertight, 6 pins

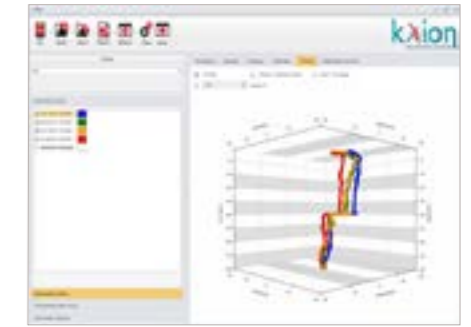

## KLION ANALYSIS SOFTWARE

KLION is a specially designed software to process inclinometer, spiral meter and T-Rex extensometer data from vertical and horizontal boreholes, providing graphs and reports. Data files may be created by manual data entry or directly from Archimede or B.R.A.IN readouts.

Advanced data analysis using Mikkelsen suggestions (FMGM 2003) are available.

### SOFTWARE MAIN FEATURES

-  User - oriented interface for managing most operations with "point and click"
-  Set-up and manage both vertical and horizontal readings
-  Automatic compensation of the inclinometer data with spiral meter survey
-  Customizable report file with advanced Word Processor
-  Charts zoom-in or zoom-out with a simple mouse scroll
-  For inclinometers, customisable charts of deformation over time are available
-  With KLION you can view the inclinometer data elaborations in a 3D graph
-  Geolocation with Google Map tool and main displacement vectors
-  On-line automatic software updates if connected to the internet
-  Multilanguage software now available in English and Italian. More languages in the next revision.

### OPERATIVE SYSTEM REQUIREMENTS

KLION works on Microsoft® Vista, 7, 8, 8.1, 10 and 11 (32 and 64 bit) HW minimum requirement: RAM 512 MB, HD 100 MB

# INCLINOMETERS



- \_LANDSLIDES
- \_DAMS
- \_UNSTABLE SLOPES
- \_PILES
- \_DIAPHRAGM WALLS
- \_TUNNELING
- \_DEEP EXCAVATIONS
- \_BRIDGES AND VIADUCTS
- \_EMBANKMENTS

Project:  
Waste water treatment plant Zimmerberg  
Switzerland



## MEMS IN-PLACE INCLINOMETER

In-Place Inclinerometers (IPI sensors) are designed for the automatic monitoring of critical locations. Jointed together by lengths of steel wire and suspended inside a vertical casing where deformation may occur, IPI sensors will follow the local inclination of the casing due to the horizontal soil movements.

### AVAILABLE MODELS

MODEL S411HA	uniaxial
MODEL S412HA	biaxial
Sensor type	self compensated MEMS
Available ranges	±10°, ±15°, ±20°, ±30°
Sensor accuracy	
Lin. MPE <sup>(1)</sup>	±0.150% FS for ±10°, ±20° ±0.200% FS for ±15°, ±30°
Pol. MPE <sup>(1)</sup>	±0.050% FS
Offset temperature dependency	±0.003° / °C
Signal output	4-20 mA current loop
Power supply	18 - 30 Vdc
Temp. operating range	-30°C to +70°C
Temperature sensor	Built-in thermistor
IP class	IP68 up to 1.0 MPa

### PROBE FEATURES

Outer diameter	Ø 30 mm
Wheel base	1000 mm
Total length	1191 mm
Material	stainless steel

### ACCESSORIES

OS4TS101000	In-place inclinometer support head
OS4IPIT00L0	In-place inclinom. clamping tool
OWRAC250000	Stainless steel support wire, 2.5 mm
OWE1061POZH	6 wires IPI cable, LSZH



## 360° MD-PROFILE IPI ARRAY

The system is suitable for geotechnical and structural applications, for which vertical or horizontal accurate profiling is needed. Featuring a patented centering device, MD-Profile 360° is the only IPI that provides accurate triaxial calibration over 360°, and eliminates the interference of the movement of one probe with respect to the two connected probes. MD-Profile 360 guarantees a repeatability of ±0.5mm over 30m.

### AVAILABLE MODELS

MODEL OMDP3600050	0.5 m gauge length
MODEL OMDP3600100	1.0 m gauge length
MODEL OMDP3600200	2.0 m gauge length
Measurement principle	Triaxial MEMS accelerometer
Measuring range	360° (±180°) on all three axes
Sensor resolution	0.0001°
MPE Accuracy <sup>(1)</sup>	<±0.02° (<±0.0055% FSR @360°) A axis: ±0.002° / °C
Offset temperature dependency	±0.002° / °C
Power supply	from 8 to 28 Vdc
Signal output and protocol	RS485, Modbus RTU <sup>(2)</sup>
Temp. operating range	-30°C to +70°C

### CENTERING DEVICE

MODEL OMDP4PRESS52	Total range from 50 to 54 mm
MODEL OMDP4PRESS58	Total range from 54 to 61 mm
MODEL OMDP4PRESS73	Total range from 69 to 76 mm

### PROBE FEATURES

Probe diameter	28 mm
Probe material	Carbon fibre rod with steel joints
Protection	IP68 up to 1.0 MPa
Standard length/weight	0.5 m/0.70 kg - 1.0 m/0.85 kg - 2.0 m length/1.10 kg

### ACCESSORIES

OMDHANGK000	MD Profile hanging kit
OS4TS101000	Support head
OETERMMDOON	MDP resist. ending device
OMDHANGK52N	Hanging kit
OMDHANGK58N	Hanging kit
OMDHANGK73N	Hanging kit
OWRAC250000	Steel pulling wire



## 360° LT-INCLIBUS ARRAY IPI ARRAY

The LT-Inclibus is able to monitor local tilting along a line, assuring the alignment, distance and measuring axis orientation between the gauges. Innovative 360° technology, allows each gauge to be calibrated over the full 360° range on three axes. This permits the LT-Inclibus to be installed in any orientation in space with no effect on measurement quality, simplifying installation operations.

### AVAILABLE MODELS

MODEL OLTIB103602	2m fiberglass rod, one gauge
MODEL OLTIB203602	2m fiberglass rod, two gauges
MODEL OLTIB403602	2m fiberglass rod, four gauges
Measurement principle	Triaxial MEMS accelerometer
Measuring range	360° (±180°) on all three axes (see WORKING PRINCIPLE on datasheet)
Resolution	0.0001°
Sensor accuracy MPE <sup>(1)</sup>	<±0.02° (<±0.0055% FSR @360°)
Offset temperature dependency	±0.002° / °C
Power supply	from 8 to 28 Vdc
Signal output and protocol <sup>(2)</sup>	RS485, Modbus RTU
Temp. operating range	from -30°C to +70°C

### GAUGE FEATURES

Gauge section dimensions	130mm x 37mm x 35mm
Material	polycarbonate, FG rod
Protection	IP68 up to 1.0 MPa (2.0 MPa on request)
Whole length	2.0m

### ACCESSORIES

OS400HD00MT	Cable with connector
OETERMRESIO	Eding resistance
OLTIBROD020	2m fibre-glass elongation rod (no sensors)

(1) MPE is the Maximum Permitted Error on the measuring range (FSR). In the Calibration Report, the accuracies of the gauge are calculated using the linear regression; the error reported is the maximum residual error on the FSR on the three axis. (2) RS485 not-optoisolated Modbus communication with RTU Protocol Default output is degree. Other units available are mm/m or inch/feet (to be requested at order). Sisgeo Modbus protocol manual is available for download on Sisgeo web site.



# INCLINOMETERS

- \_LANDSLIDES
- \_DAMS
- \_UNSTABLE SLOPES
- \_PILES
- \_DIAPHRAGM WALLS
- \_TUNNELING
- \_DEEP EXCAVATIONS
- \_BRIDGES AND VIADUCTS
- \_EMBANKMENTS

Project:  
Metro Line C  
Colosseum monitoring  
Rome, Italy



## BH-PROFILE IN-PLACE INCLINOMETER

BH-profile gauges are designed for automatic monitoring of critical locations where displacement request a nearly-real time monitoring. The gauge consists of a stainless steel body with on one side the connection for carbon fibre extension rod and on the other side a stainless steel carriage with spring-loaded wheels.

### AVAILABLE MODELS

MODEL S431HD	vertical uniaxial range $\pm 10^\circ, \pm 15^\circ$
MODEL S432HD	vertical biaxial range $\pm 20^\circ, \pm 30^\circ$
Sensor type	BIAXIAL MEMS inclinometer
Sensor resolution	0.0001°
Sensor repeatability	$\pm 0.001^\circ$
Sensor accuracy MPE <sup>(1)</sup>	$< \pm 0.01\%$ FSR
Offset temperature dependency	$\pm 0.002^\circ / ^\circ\text{C}$
Power supply	from 8 to 28 Vdc
Signal output	RS-485 with Modbus RTU protocol <sup>(2)</sup>
Temp. operating range	$-30^\circ\text{C}$ to $+70^\circ\text{C}$
Built-in temperature sensor	Temperature sensor (embedded in electronic board)
Range / accuracy	from $-40^\circ\text{C}$ to $+125^\circ\text{C} / \pm 1^\circ\text{C}$ ( $-10^\circ\text{C} + 85^\circ\text{C}$ )

### PROBE FEATURES

Sensed probe diameter	30 mm
Sensed probe material	stainless steel
Protection	IP68 up to 1 MPa
Extension rod	stainless steel joint tips and carbon fiber rod, 20 mm OD

### ACCESSORIES

OS430EX00RD	Carbon fibre extension rod
OS43WHE2SSO	Terminal wheels assembly
OS400HD00MT	Upper cable with connector
OS4TS101000	Inclinometer support head
OWE606IPDZH	Digital inclinometer cable
OEPD023IPID	Digital junction box
OWRAC250000	Support steel wire
OETERMRESIO	Resistance ending device



## HORIZONTAL IN-PLACE INCLINOMETER

Horizontal IPI gauge consists of a stainless steel body with on one side the connection for carbon fibre extension rod and on the other side a stainless steel carriage with spring-loaded wheels. A string of horizontal IPIs is usually installed inside inclinometer casing buried within trenches, foundations or horizontal drill hole for automatic monitoring of settlement or heave.

### AVAILABLE MODELS

MODEL S441HD	Uniaxial MEMS inclinometer
Available ranges	$\pm 10^\circ, \pm 15^\circ, \pm 20^\circ, \pm 30^\circ$
Sensor resolution	0.0001°
Sensor repeatability	$< \pm 0.001^\circ$
Sensor accuracy MPE <sup>(1)</sup>	$< \pm 0.01\%$ F.S.R
Offset temperature dependency	$\pm 0.002^\circ / ^\circ\text{C}$
Power supply	from 8 to 28 Vdc
Signal output	RS-485 with Modbus RTU protocol <sup>(2)</sup>
Temp. operating range	from $-30^\circ\text{C}$ to $+70^\circ\text{C}$
Built-in temperature sensor	Temperature sensor (embedded in electronic board)
Range / accuracy	from $-40^\circ\text{C}$ to $+125^\circ\text{C} / \pm 1^\circ\text{C}$ ( $-10^\circ\text{C} + 85^\circ\text{C}$ )

### PROBE FEATURES

Sensed probe diameter	30 mm
Sensed probe material	stainless steel
Protection	IP68 up to 1.0 MPa
Extension rod	stainless steel joint tips and carbon fiber rod, 20 mm OD

### ACCESSORIES

OS430EX00RD	Carbon fibre extension rod
OS43WHE2SSO	Terminal wheels assembly
OS4ROD00SUP	Horiz. rods support carriage
OS4ROD0AC00	Push/fasten rods
ODEXOTS2350	Horizontal IPI protective cap

(1) MPE is the Maximum Permitted Error on the measuring range (FSR). In the Calibration Report, the accuracies of the gauge are calculated using the linear regression; the error reported is the maximum residual error on the FSR.

(2) RS485 not-optoisolated Modbus communication with RTU Protocol. Default output is sen , other units available are degree, mm/m and inch/feet (to be requested at order). Sisgeo Modbus protocol manual is available on Sisgeo website.

## EXAMPLE OF BH-PROFILE CHAIN

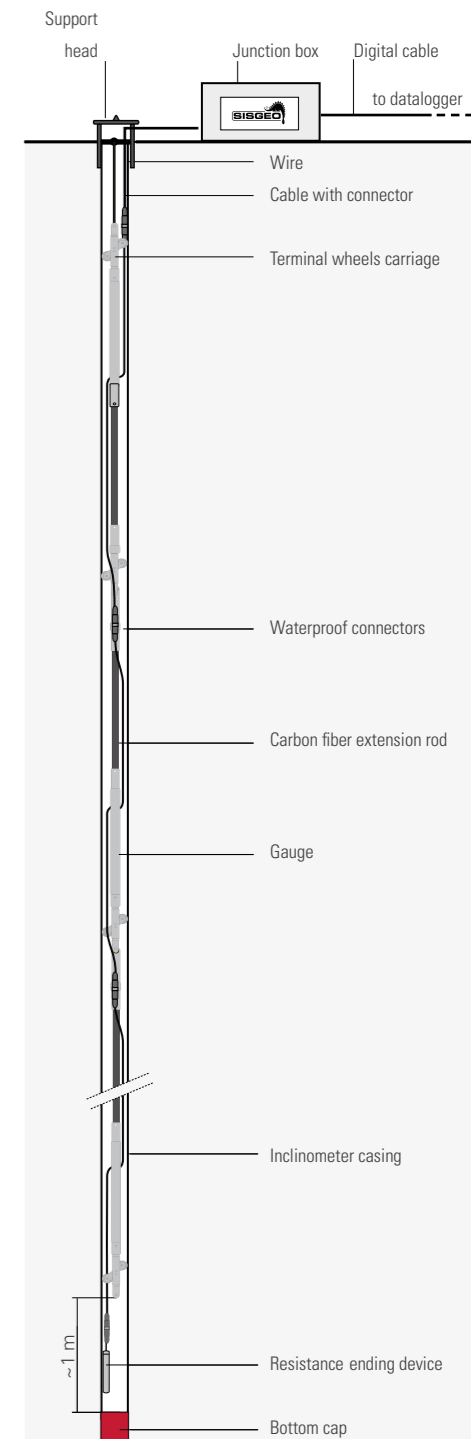

# TILTMETERS

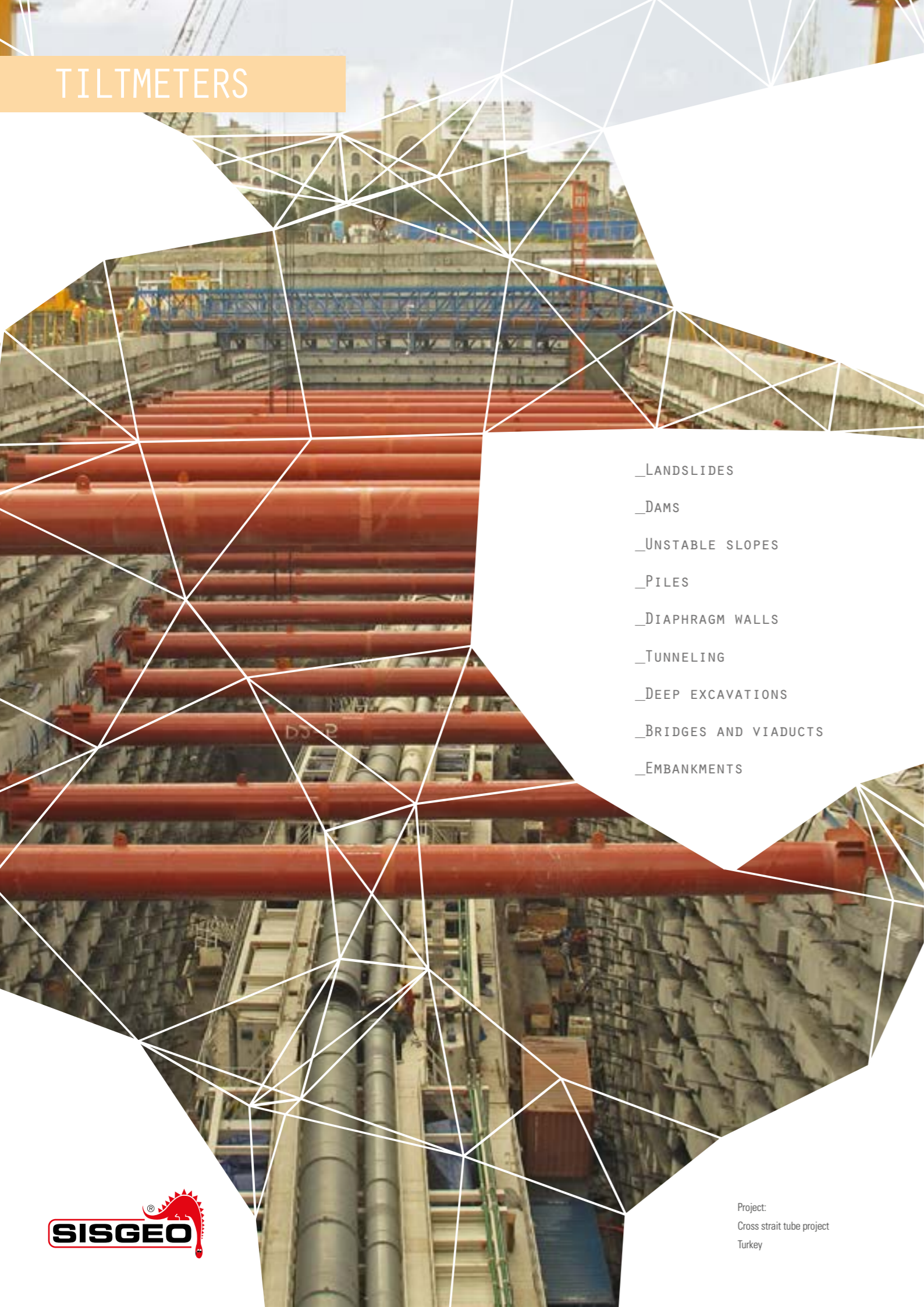

- \_LANDSLIDES
- \_DAMS
- \_UNSTABLE SLOPES
- \_PILES
- \_DIAPHRAGM WALLS
- \_TUNNELING
- \_DEEP EXCAVATIONS
- \_BRIDGES AND VIADUCTS
- \_EMBANKMENTS

Project:  
Cross strait tube project  
Turkey



## MEMS ANALOGUE TILT METERS

Inclinations measurement is essential for the supervision and for the security of civil structures in elevation during the construction and the operation phases. MEMS tiltmeters monitor tilt changes in either one or two axial planes perpendicular to the surface of the base plate. MEMS analog tiltmeters are permanently installed to provide a long term observation.

### AVAILABLE MODELS

MODEL S541MA	uniaxial range $\pm 2.5^\circ$ , $\pm 5^\circ$ , $\pm 10^\circ$
MODEL S542MA	biaxial range $\pm 2.5^\circ$ , $\pm 5^\circ$ , $\pm 10^\circ$
MODEL OS521MA	uniaxial range $\pm 5^\circ$ , $\pm 10^\circ$
MODEL OS522MA	biaxial range $\pm 5^\circ$ , $\pm 10^\circ$
Measurement principle	Self-compensated MEMS inclinometer
Sensor resolution	0.01% FS
Accuracy:	
Lin. MPE <sup>(1)</sup>	$\pm 0.008^\circ$ for $\pm 2.5^\circ$ range, $\pm 0.012^\circ$ for $\pm 5^\circ$ range, $\pm 0.020^\circ$ FS for $\pm 10^\circ$ range
Pol. MPE <sup>(1)</sup>	$\pm 0.004^\circ$ for $\pm 2.5^\circ$ range, $\pm 0.006^\circ$ for $\pm 5^\circ$ range, $\pm 0.010^\circ$ for $\pm 10^\circ$ range
Output signal	4-20 mA current loop (inclination), Ohm (temperature)
Power supply	18 - 30 Vdc
Offset temperature dependency	$\pm 0.003^\circ / ^\circ\text{C}$ (from $-20^\circ\text{C}$ to $+70^\circ\text{C}$ )
Temp. operating range	$-30^\circ\text{C}$ to $+70^\circ\text{C}$
Overall dimensions (LxHxW)	99 x 115 x 49 mm (including connectors)
Material and IP class	anodized aluminum, IP67

### ACCESSORIES

OS540AP3D02	Fine adjustment base plate especially recommended for small ranges ( $\pm 2.5^\circ$ and $\pm 5^\circ$ )
-------------	--

(1) MPE is the Maximum Permitted Error on the measuring range (FSR). In the Calibration Report, the accuracies of the gauge are calculated using both linear regression ( $\leq$  Lin. MPE) and polynomial correction ( $\leq$  Pol. MPE).

(2) RS485 not-optoisolated Modbus communication with RTU Protocol Default output is degree. Sisgeo Modbus protocol manual is available for download on Sisgeo web site.



## 360° DIGITAL MEMS TILTMETER

The 360° MEMS Tiltmeter is specifically designed for applications that demand high accuracy and minimal thermal drift, without concerns regarding instrument positioning. Thanks to 360° technology, each MEMS tiltmeter can be calibrated across the full 360° range on three axes. This feature enables the instrument to be installed in any orientation, without impacting measurement quality.

### AVAILABLE MODELS

MODEL OS543HD3600	Triaxial MEMS accelerometer
Measuring range	360° ( $\pm 180^\circ$ ) on all three axes (see WORKING PRINCIPLE on datasheet)
Resolution	0.0001°
MPE Accuracy <sup>(1)</sup>	$\leq \pm 0.02^\circ$ ( $\leq \pm 0.0055\%$ FSR @360°)
Repeatability	$\leq \pm 0.001^\circ$
Sensor mechanical bandwidth	1 Hz
Offset temperature dependency	$\pm 0.002^\circ / ^\circ\text{C}$
Power supply	from 8 to 28 Vdc
Signal output and protocol	RS485, Modbus RTU <sup>(2)</sup>
Temp. operating range	$-30^\circ\text{C}$ to $+70^\circ\text{C}$
Overall dimensions (LxHxW)	151 x 55 x 49 mm (including connectors)
Material and IP class	anodized aluminum, IP65

### ACCESSORIES

OETERMRESIO	Termination resistance with connector, needed to close every digital instrument chain.
OERESIKIT00	Spare kit consisting of one 120-ohm resistor, two 240-ohm resistors, three 360-ohm resistors, and four 480-ohm resistors.
OECONOST3K0	Spare connector kit for tiltmeters.



## TILT BEAM SENSORS

Tilt Beam (TB) sensors can be used both in chain to measure a continuous displacement or in stand alone application to measure the tilt-displacement between two point (ends of the beam). TB are available in both analogue model or 360° digital version. The special design of tilt beam permits to install it with any orientation (vertical, horizontal or sub-horizontal).

### TILT BEAM SENSORS

MODEL S541MA	Uniaxial self-compensated MEMS inclinometer
MODEL S542MA	Biaxial self-compensated MEMS inclinometer
Application	horizontal, vertical or inclined
Range	$\pm 2.5^\circ$ , $\pm 5^\circ$ , $\pm 10^\circ$
Sensor resolution	0.001°
(reading frequency 2 Hz)	
Accuracy: Pol. MPE <sup>(1)</sup>	$\pm 0.004^\circ$ for $\pm 2.5^\circ$ range, $\pm 0.006^\circ$ for $\pm 5^\circ$ range, $\pm 0.010^\circ$ FS for $\pm 10^\circ$ range
Offset temperature dependency	$\pm 0.003^\circ / ^\circ\text{C}$ (from $-20^\circ\text{C}$ to $+70^\circ\text{C}$ )
Signal output	4-20 mA current loop (inclination), Ohm (temperature)
Power supply	From 18 to 30 VdC
Temp. operating range	$-30^\circ\text{C}$ to $+70^\circ\text{C}$

### 360° TILT BEAM SENSOR

MODEL OS543HD3600	Triaxial MEMS accelerometer
Range	360° ( $\pm 180^\circ$ ) on all three axes with respect to g
Sensor resolution	0.0001°
(reading frequency 2 Hz)	
Accuracy: Pol. MPE <sup>(1)</sup>	$\leq \pm 0.02^\circ$ @360° range
Offset temperature dependency	$\pm 0.002^\circ / ^\circ\text{C}$ (from $-20^\circ\text{C}$ to $+70^\circ\text{C}$ )
Signal output and protocol	RS485, Modbus RTU <sup>(2)</sup>
Power supply	from 8 to 28 Vdc
Temp. operating range	from $-30^\circ\text{C}$ to $+70^\circ\text{C}$

### BEAMS

OS7BM100002	1 meter beam
OS7BM200002	2 meter beam
OS7BM300002	3 meter beam
Material	Aluminium
Beam section	44 x 60 mm (WxH)



- \_LANDSLIDES
- \_DAMS
- \_UNSTABLE SLOPES
- \_PILES
- \_DIAPHRAGM WALLS
- \_TUNNELING
- \_DEEP EXCAVATIONS
- \_BRIDGES AND VIADUCTS
- \_EMBANKMENTS



## TILLI PORTABLE TILTMETER

TILLI is a rugged portable tiltmeter. It consists of a durable stainless steel frame with an aluminium housing containing a self compensated MEMS tilt sensor. The surfaces of the frame are machined to allow the accurate positioning of the tiltmeter during successive measurements. A single TILLI can be used to measure any number of pre-installed tilt plates.

### OSCLIN150H0 TILTMETER

TILLI sensor	uniaxial self compensated MEMS
Measuring range	±15° from the vertical
Sensor resolution @ 2 Hz	0.00056° (0.01 mm/m)
Repeatability	< ±0.003°
Temperature dependency	< ±0.005% FS / °C
Temp. operating range	-30°C to +70°C
Material stainless	Stainless steel frame anodised AL sensor housing
Weight	3 Kg (TILLI only)
Carrying case	IP68 shock-resistant plastic



Measuring activity with TILLI

### OSCLTP14B00 TILT PLATE

Material	Brass
Dimensions (OD x thickness)	135 x 23 mm



## SUBMERSIBLE MEMS TILTMETER

Submersible tiltmeters are designed for in-place applications on surfaces below the water level or where flooding may occur. Submersible tiltmeters are equipped with MEMS sensors and mounted on a base plate in order to monitor tilt changes in either one or two axial planes perpendicular to the surface of the base plate.

### AVAILABLE MODELS

MODEL S521MA	uniaxial
MODEL S522MA	biaxial
Sensor type	self-compensated MEMS inclinometer
Available ranges	±5°, ±10°
Sensor resolution	0.01% FS
Accuracy: Lin. MPE <sup>(1)</sup>	±0.012° for ±5° range, ±0.020° FS for ±10° range
Pol. MPE <sup>(1)</sup>	±0.006° for ±5° range, ±0.010° for ±10° range
Offset temperature dependency (from -20°C to +70°C)	±0.003° / °C
Signal output	4-20 mA current loop
Power supply	18 - 30 V DC
Temp. operating range	From -30°C to +70°C
Overall dimensions	36 x 68 x 245 mm (LxWxH)
Material and protection	stainless steel, IP68 until 1.0 MPa

### ACCESSORIES

OS500PF1000  
Stainless steel base plate with three anchors for wall mounting.  
Overall diam: 100 mm



OS500AP3600  
"L" shaped base plate for installation of submersible tilt meters on sloped surface.



(1) MPE is the Maximum Permitted Error on the measuring range (FSR). In the Calibration Report, the accuracies of the gauge are calculated using both linear regression (≤ Lin. MPE) and polynomial correction (≤ Pol. MPE).

## EXAMPLE OF SUBMERSIBLE TILTMETER INSTALLATION



Submersible tilt meter installed on up-stream face of Sogamoso Dam - Colombia (190mt high)

# SETTLEMENT GAUGES

- \_ BUILDINGS
- \_ EMBANKMENTS
- \_ FOUNDATIONS
- \_ CIVIL STRUCTURES
- \_ TUNNELING
- \_ CONCRETE AND EARTHFILL DAMS

Project:  
Astana National Library  
Kazakhstan



## H-LEVEL LIQUID LEVEL SYSTEM

The H-Level is the automatic liquid level system for accurate long-term monitoring of differential settlements in buildings, tunnels, and other civil structures. It consists of a series of H-Level gauges that are hydraulically connected to a reference tank positioned in a stable location. Each H-Level gauge includes a high resolution pressure sensor that monitors the head of liquid resulting from the difference in elevation between the gauge and the reference tank.

### DIGITAL H-LEVEL GAUGES

OHLEV050D02	DIGITAL H-LEVEL GAUGE, 500 mm FS
OHLEV100D02	DIGITAL H-LEVEL GAUGE, 1000 mm FS
Sensor type	capacitive ceramic sensor
Measuring range	500 or 1000 mm H <sub>2</sub> O (Other on request)
Gauge resolution	0.002% FS
Gauge accuracy MPE <sup>(1)</sup>	±0.07% FS (< ±0.35 mm H2O) with 500mm range ±0.07% FS (< ±0.70 mm H2O) with 1000mm range
Offset (10%FS) temp dependency (-20°C to +60°C)	< ±0.01 mm/°C with 500mm range < ±0.03 mm/°C with 1000mm range
Internal sensors (embedded on electronic board)	Temperature, humidity and supply voltage monitor
Output signal	RS-485, Modbus RTU protocol <sup>(2)</sup>
Operating temperature	-20°C to +70°C
Housing dimensions (WxHxD)	75 x 175 x 50 mm
Housing material	Anodized aluminum

### ANALOGUE H-LEVEL GAUGES

OHLEV050002	H-LEVEL GAUGE, 500 mm FS
OHLEV100002	H-LEVEL GAUGE, 1000 mm FS
Sensor type	capacitive ceramic pressure sensor
Measuring range	500 or 1000 mm H <sub>2</sub> O (Other on request)
Gauge resolution	infinite (0.006% FS with OMNIAlog datalogger)
Gauge accuracy MPE <sup>(1)</sup>	±0.15% FS with 500mm range ±0.10% FS with 1000mm range
Offset (10%FS) temp dependency (-20°C to +60°C)	< ±0.04 mm/°C with 500mm range < ±0.05 mm/°C with 1000mm range
Output signal	4-20mA (pressure), Ohm (temperature)
Operating temperature	-20°C to +60°C
Housing dimensions (WxHxD)	75 x 175 x 50 mm
Housing material	Anodized aluminum



## MULTIPOINT SETTLEMENT SYSTEM

The multipoint settlement system consists of a number of hydraulic settlement gauges connected by tubing to a reference tank located on a higher, stable ground. The settlement gauge is a pressure transducer with vibrating wire or capacitive technology, mounted on a plate with a protective cover. Depending on the requirement, the settlement system can be installed with just a single gauge or with multiple gauges.

### OD422R000MA ELECTRICAL GAUGE

Sensor type	capacitive vented pressure
Measuring range	20 kPa, 50 kPa, 100 kPa 2.01 m, 5.02 m, 10.05 m with Sisgeo liquid
Accuracy Pol. MPE <sup>(1)</sup>	< +/-0.15%FS
Sensor power supply	15 – 24 V DC
Output signal	4-20 mA (pressure)

### OD422R000VW VIBRATING WIRE GAUGE

Sensor type	vibrating wire non-vented pressure transducer with built-in thermistor
Measuring range	170 kPa, 350 kPa, 700 kPa 17.08 m, 35.17 m, 70.34 m with Sisgeo liquid
Sensor sensitivity	0.025% FS
Accuracy Pol. MPE <sup>(1)</sup>	< ±0.25% FS
Output signal	frequency (pressure), Ohm (thermistor)

### COMPONENTS AND ACCESSORIES

OD422SERB00	SIMPLE REFERENCE VESSEL
OMEPRO106000	BAROMETER
OTUNY060800	POLYAMIDE TUBE FOR HYDRAULIC CONNECTION OF THE SETTLEMENT GAUGES. 8 MM OD, 6 MM ID.
1000GL30000	WATER-GLYCOL MIX
1000COPE300	HYDRAULIC CIRCUIT INSULATION
OD422SAT200	SATURATION DEVICE



## PRISMS AND TARGETS

Topographic monitoring requires accessories such as bolts, prisms, and targets. Reference bolts are threaded to accept optical targets. Rotary targets can be also mounted on a simple threaded bar or attached to an inexpensive "L" shaped bracket. The GMP104 equivalent to the Leica mini-prism provides good survey performance. Its aluminum bracket can be mounted and adjusted easily for 3D surveys.

### OGMP1040000 MINIPRISM

Max I.R. range	2000 m
Prism diameter	24 mm
Prism body dimensions	Ø 60 mm, thickness 27 mm
Diameter	34 mm
L-support	aluminum, 12 x15 mm section
Overall dimensions	76 x 90 x 27 mm

### OPTICAL TARGETS

OGCTR005000	REMOVABLE OPTICAL TARGET
OGCTR38ADP0	PVC 3/8" female adaptor
OGCTR0050TS	TARGET 50 x 50 MM PVC rotary support, stainless steel anchor

### TOPOGRAPHIC BOLTS

0GBM020SS00	Head dimensions: Ø 20 mm, Ø 27 mm Body section: 8 x 15mm Total length: 177 mm Material: stainless steel
0GBM040SS00	Head dimensions: Ø 40 mm, Ø 27 mm Body section: 8 x 15mm Total length: 177 mm Material: stainless steel

(1) MPE is the Maximum Permitted Error on the measuring range (FSR). In the Calibration Report, the accuracies of the gauge are calculated using the linear regression; the error reported is the maximum residual error on the FSR.

(2) RS485 not-optoisolated Modbus communication with RTU Protocol. Default output is "m H2O". Sisgeo Modbus protocol manual is available for download on Sisgeo web site.

# SETTLEMENT GAUGES

- \_ BUILDINGS
- \_ EMBANKMENTS
- \_ FOUNDATIONS
- \_ CIVIL STRUCTURES
- \_ TUNNELING
- \_ CONCRETE AND EARTHFILL DAMS

Project:  
Chuquicamata Mine  
Chile



## T-REX INCREMENTAL EXTENSOMETER

T-REX is a removable extensometer which has been designed for incremental measurements along the axis of an inclinometer casing equipped with ring magnets. Thanks to the positioning device, T-REX digital probe gives accurate measurements. KLION analyzer software includes a smoothing technique that allows the "best fit" in order to evaluate the real behaviour of the soil movements

### OREX45100D0 DIGITAL T-REX SYSTEM

T-REX digital extensometer offers several advantages:

- wide measuring range ( $\pm 40$  mm displacement per meter) which allows applications either in soil or rock
- fully compatible with Sisgeo BRAIN inclinometer system (cable, connector and BRAIN APP)
- no mechanical contact between probe and targets
- combined with inclinometer permits 3-D deformation borehole profile

Measuring base	1.000 mm
Measuring range	$\pm 40$ mm
Probe repeatability	0.01 mm/m
Signal output	RS485 Modbus RTU <sup>(1)</sup>
Operating temperature	-30°C +75°C
IP class	IP68 up to 2.0 MPa
Dimensions	$\varnothing$ 40 mm, length 1664 mm
Material	Aluminum body and steel parts

### BRAIN REEL AND APP

Measurements are performed with B.R.A.IN bluetooth reel (product code OS2RC6000B0), available in different length from 30m up to 250m. APP available for both Android and Apple devices.

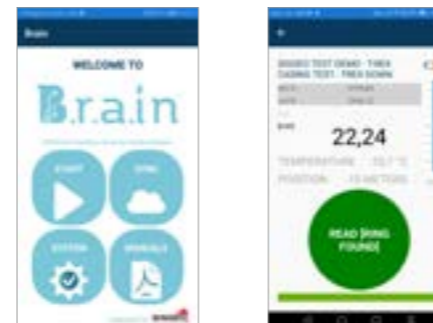

SISGEO.COM



## DEX-S 3D EXTENSO-INCLINOMETERS

The DEX-S extenso-inclinometer is a 3D probe with an exclusive merge of two sensors: a high accuracy MEMS biaxial inclinometer to read displacements on horizontal plane, and a contactless magnetic sensor to monitor the vertical displacements. A chain of probes installed in a borehole offers the unique advantage to return a 3-D profile of both the casing and surrounding ground in which the chain is installed.

### DIGITAL DEX-S SPECIFICATIONS

ODEXS01030D	Range $\pm 50$ mm, length 1080 mm
ODEXS05030D	Range $\pm 250$ mm, length 1480 mm
ODEXS10030D	Range $\pm 500$ mm, length 1980 mm
Tilt sensor type	biaxial MEMS inclinometer
Sensor resolution	0.0001°
Sensor accuracy MPE <sup>(1)</sup>	$\leq \pm 0.01\%$ FSR
Temperature sensor	accuracy $\pm 1^\circ\text{C}$ with temperature range -10°C to +85°C
Int. humidity sensor	$\pm 5\%$ RH with humidity range 0 to 95% RH
Signal output	RS-485 with Modbus RTU protocol <sup>(2)</sup>
Temperature operating range	-30°C +70 °C
Environmental	IP68 up to 1.0 MPa (higher pressure rating available on request)

### COMPONENTS AND ACCESSORIES

OS400H001C	INTERPROBE CABLE ASSEMBLY
OS400H00MT	UPPER CABLE WITH CONNECTOR
OWRAC250000	SUPPORT STEEL WIRE
OS4TS101000	SUPPORT HEAD
OWE6061PDZH	DIGITAL CABLE
OEPD0231PID	DIGITAL JUNCTION BOX
OC121000000	MAGNETIC DETECTOR PROBE
OS4IPIT00L0	INSTALLATION KIT

(1) MPE is the Maximum Permitted Error on the measuring range (FSR). In the Calibration Report, the accuracies of the gauge are calculated using the linear regression; the error reported is the maximum residual error on the FSR.

(2) RS485 not-optoisolated Modbus communication with RTU Protocol. Default output is [mm] for settlement sensor and [sin  $\alpha$ ], for tilt sensor. Other units are available and to be requested at order. Sisgeo Modbus protocol manual is available for download on [www.sisgeo.com](http://www.sisgeo.com)

## EXAMPLE OF DEX-S 3D EXTENSO-INCLINOMETERS

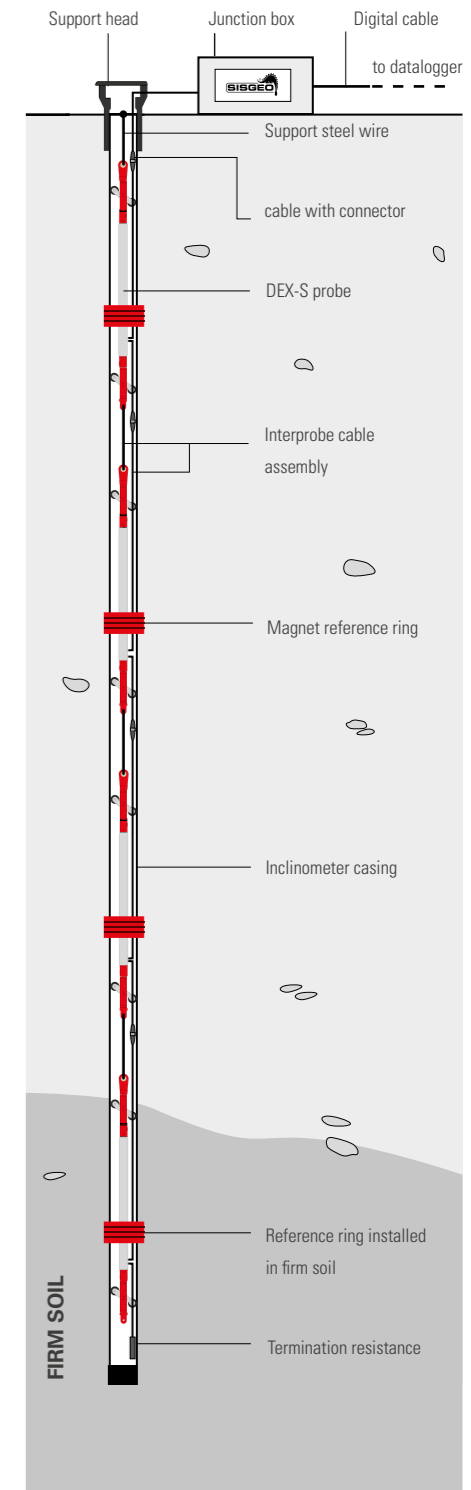

# SETTLEMENT GAUGES

- \_ BUILDINGS
- \_ EMBANKMENTS
- \_ FOUNDATIONS
- \_ CIVIL STRUCTURES
- \_ TUNNELING
- \_ CONCRETE AND EARTHFILL DAMS

Project:  
Nam Gnouang Dam  
Laos



## FIXED EXTENSOMETER

Fixed extensometer is usually defined as a device placed in an embankment fill or inside a borehole for monitoring settlement or heave between two points. Optical surveying of the top of the riser rod provides precise monitoring. Electrical transducers can be used for automatic readings in remote inaccessible locations.

### TELL-TALE EXTENSOMETER

TT extensometer is a single point extensometer which is typically used for precise monitoring of ground surface settlement or heave.

OD100A20060	MEASURING ROD
OD111PV5500	CORRUGATED SHEATH
OD100TT0160	MEASURING HEAD
OD100TT6060	BOTTOM ANCHOR

### SETTLEMENT PLATFORM

Settlement platforms are typically used for monitoring settlement below embankments on soft ground.

OD100A20060	SETTLEMENT ROD OD 25 mm
OD111PV5500	CORRUGATE SHEATH OD 55 mm
OD100B05060	SETTLEMENT PLATE
OD100T15060	SURVEY POINT OD 40 mm

### ELECTRICAL TT EXTENSOMETER

Tell tale (TT) extensometers can be equipped with DTM electrical displacement transducer in order to automatize the readings and allow remote monitoring through automatic data logger.

OD100A20060	MEASURING ROD
OD111PV5500	CORRUGATED SHEATH
OD100TTEL16	MEASURING HEAD
OD100TT6060	BOTTOM ANCHOR

### DTM ELECTRICAL TRANSDUCERS

ODTMOAE0250	Range 250 mm
ODTMOAE0500	Range 500 mm
ODTMOAE01000	Range 1000 mm
Accuracy Pol MPE <sup>(1)</sup>	± 0.15 % FS
Output signal	4-20 mA current loop
IP class	IP68 up to 2 MPa

SISGEO.COM



## MAGNET EXTENSOMETER (BRS)

Magnet extensometer is a system for measuring either settlement or heave at various depths in soil and embankments. The system consists of an access tube with external corrugated pipe and ring magnets. Readings are obtained lowering in the access tube a portable readout equipped with a reed switch probe.

### SETTLEMENT COLUMN

OD111P30000	3 M SECTION ACCESS TUBE
OD111PV5500	CORRUGATED SHEATH, OD 55 MM
OD111TF6000	BOTTOM END
OD111TS1000	SUSPENSION HEAD
OD111AF6000	3-SPRING SETTLEMENT RING
OD111AR6000	SETTLEMENT PLATE
	ID 60 mm, plate OD 300 mm
OD111AF6060	6-SPRING SETTLEMENT RING
	ID 60 mm, max span 300 mm

### INCLINO-SETTLEMENT COLUMN

OS143107000	INCLINOMETER TUBE
OS143ST0700	TELESCOPIC SECTION, 75MM
OS143ST1500	TELESCOPIC SECTION, 150MM
OS143AF6000	3-SPRING MAGNET RING
OS143AF6060	6-SPRING MAGNET RING
OS143AR6000	EMBANKMENT RING
OS143DR7000	DATUM REFERENCE

### C121 PORTABLE READOUT

OC121005000	READOUT, 50 M FLAT CABLE
OC121010000	READOUT, 100 M FLAT CABLE
OC121015000	READOUT, 150 M FLAT CABLE
OC121020000	READOUT, 200 M FLAT CABLE
OC121KITR00	DETECTOR PROBE SPARE SET
Measuring tip	OD 16 mm, length 250 mm
Cable division	millimetre, class II ECC
Cable sheath	nylon
Number of conductors	two
Temp. operating range	-40°C +100°C

(1) MPE is the Maximum Permitted Error on the measuring range (FSR). In the Calibration Report, the accuracies of the gauge are calculated using the linear regression; the error reported is the maximum residual error on the FSR.

(2) RS485 not-optoisolated Modbus communication with RTU Protocol. Default output is [mm] for settlement sensor and [sin α], for tilt sensor. Other units are available and to be requested at order. Sisgeo Modbus protocol manual is available for download on [www.sisgeo.com](http://www.sisgeo.com)

## EXAMPLE OF MAGNET EXTENSOMETER COLUMN

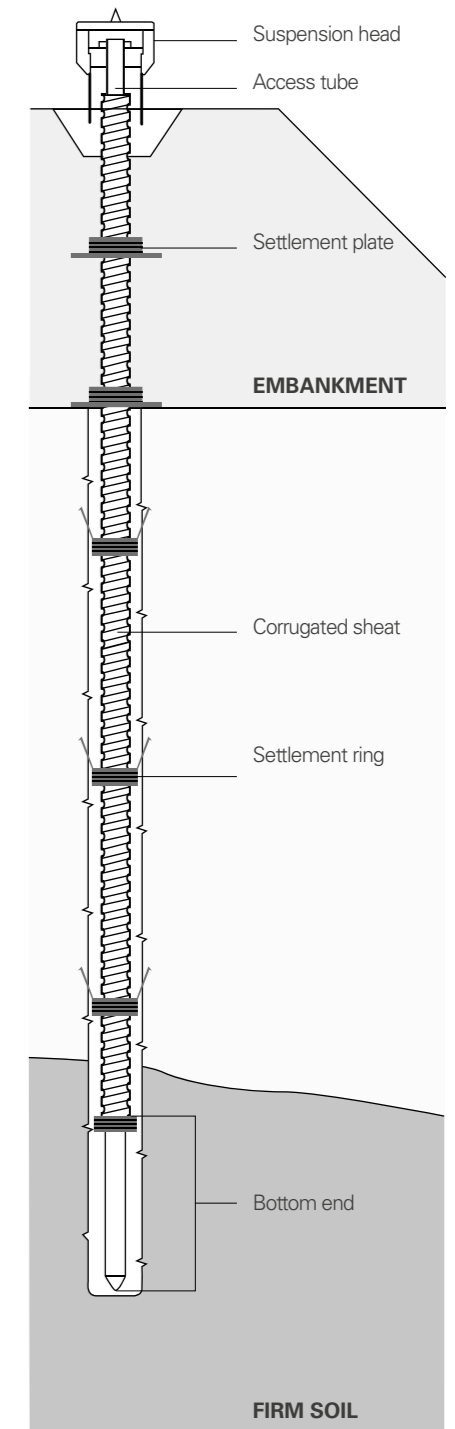

# PRESSURE & LOAD CELLS



- \_ EMBANKMENTS
- \_ TUNNELING
- \_ CONCRETE MASS
- \_ EARTH FILL DAMS
- \_ PILES
- \_ DIAPHRAGM WALLS
- \_ DEEP EXCAVATIONS
- \_ BRIDGES AND VIADUCTS

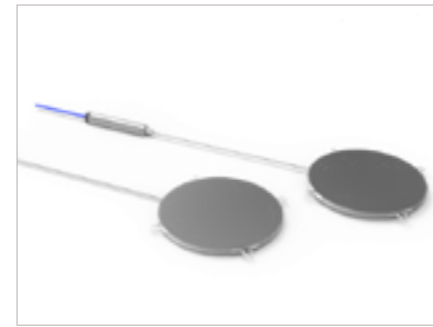

## EARTH PRESSURE CELLS

Earth pressure cells are designed to monitor total pressure in earthfill dams, embankments, and at the interface between structures and soil. Pressure applied to the surface of the pressure cell is transmitted hydraulically to a pressure transducer which can be read with a portable readout or a datalogger.

### AVAILABLE MODELS

MODEL L143	VW pressure transducer
Full scales	0-350 kPa up to 0-10.0 MPa 0-50 psi up to 0-1450 psi
Sensitivity	0.03% FS
Pol. MPE <sup>(1)</sup>	< ±0.25% FS (< ±0.1% FS on request)
Temperature sensor	built-in thermistor
Overload	100% FS
Typical frequency range <sup>(2)</sup>	2250 - 3000 Hz
Signal output	frequency
Pressure pad size	diameter 230 mm thickness 12 mm
Transducer size	OD 28 mm, 180 mm long OD 1", 7.1" long
Material	Stainless steel
Operating temp. Range	-20°C +80°C
Weight	0.6 kg

(1) MPE is the Maximum Permitted Error on the measuring range (FSR). In the Calibration Report, the accuracies of the gauge are calculated using both linear regression (≤ Lin. MPE) and polynomial correction (≤ Pol. MPE)

(2) The expressed frequency may vary +/-10% (3) Refer to FAQ section of Sisgeo website: [www.sisgeo.com/faq](http://www.sisgeo.com/faq)

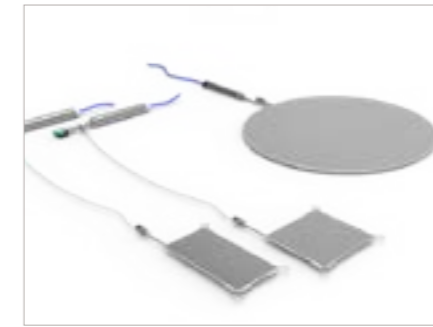

## HYDRAULIC PRESSURE CELLS

Hydraulic pressure cells are designed to measure stress in mass concrete or in the interface between the structure and the excavation wall. They are filled under vacuum with de-aired oil that guarantees the maximum rigidity. A re-pressurizing device is used in order to maintain close contact when the concrete has cured.

### AVAILABLE PRESSURE PADS

0L111151500	for radial stress in concrete
Pad size	150 x 150 mm
Working pressure	up to 5.0 MPa (up to 725 psi)
0L111102000	for tangential stress in concrete
Pad size	100 x 200 mm (3.9" x 7.9")
Working pressure	up to 20.0 MPa (up to 2900 psi)
0L111152500	for contact soil/rock-structure
Pad size	150 x 250 mm (5.9" x 9.8")
Working pressure	up to 10.0 MPa (up to 1450 psi)
0L111204000	for contact soil/rock-structure
Pad size	200 x 400 mm (7.9" x 15.7")
Working pressure	up to 5 MPa (up to 725 psi)
0L111D05000	for contact soil-concrete
Pad size	circular 500 mm OD (19.7" OD)
Working pressure	up to 1 MPa (up to 145 psi)

### AVAILABLE TRANSDUCERS

MODEL PK45H	VW pressure transducers
Full scales (FS)	0-350 kPa up to 0-20.0 MPa 0-50 psi up to 0-2900 psi
Sensitivity	0.03% FS
Accuracy: Pol. MPE <sup>(1)</sup>	< ±0.25% FS (< ±0.1% FS on request)
Output signal	frequency
Operating temp. range	-20°C +80°C (OD 1", 7.1" long)
Transducer size	OD 27 mm, 180 mm long
MODEL P252A	Piezo-resistive pressure transducer
Full scales (FS)	0-200 kPa up to 0-20.0 MPa, 0-29 psi up to 0-2900 psi
Sensitivity	0.002% FS
Accuracy: Pol. MPE <sup>(1)</sup>	< ±0.20% FS (for 200kPa FS) < ±0.15% FS (all other FS)
Output signal	4-20 mA current loop
Operating temp. range	-20°C +80°C
Transducer size	OD 27 mm, 180 mm long

## EXAMPLE OF EARTH PRESSURE CELLS INSTALLATION

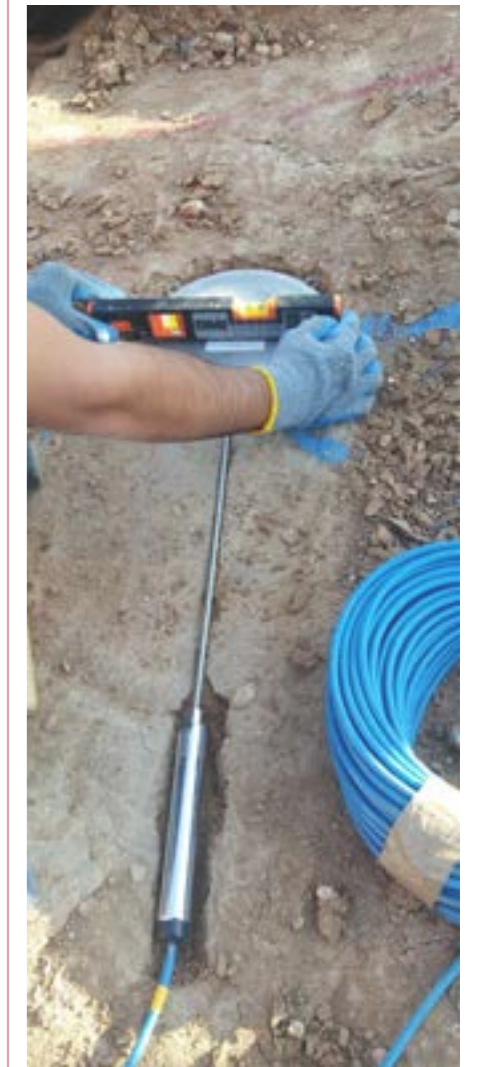

# PRESSURE & LOAD CELLS

- \_ EMBANKMENTS
- \_ TUNNELING
- \_ CONCRETE MASS
- \_ EARTH FILL DAMS
- \_ PILES
- \_ DIAPHRAGM WALLS
- \_ DEEP EXCAVATIONS
- \_ BRIDGES AND VIADUCTS



## HYDRAULIC ANCHOR LOAD CELLS

Hydraulic anchor load cells are used to monitor loads in tiebacks, rock bolts and cables. The pressure pad between the plates is filled, under high vacuum, with deaired oil. The load is directly measured in KN through a Bourdon manometer. Electrical conversion using pressure transducer is also available for remote readings.

### GAUGE MANOMETER MODEL OL2M0\*

OL2M07050H0	500 KN, ID 71 MM, OD 163 MM
OL2M09075H0	750 KN, ID 92 MM, OD 196 MM
OL2M11100H0	1000 KN, ID 110 MM, OD 231MM
OL2M16150H0	1500 KN, ID 165 MM, OD 293 MM
Description	Hydraulic load cell equipped with Bourdon gauge manometer
Overload	120% with less than 2% FS zeroshift
Manometer accuracy	class ±1.5% FS
Material	AISI 304 stainless steel
Comp. temp. range	-35°C +60°C

### ELECTRICAL MODEL OL2E0\*

OL2E0705000	500 KN, ID 71 MM, OD 163 MM
OL2E0907500	750 KN, ID 92 MM, OD 196 MM
OL2E1110000	1000 KN, ID 110 MM, OD 231 MM
OL2E1615000	1500 KN, ID 165 MM, OD 293 MM
Description	Hydraulic load cell equipped with electrical pressure transducer
Overload	120% with less than 2% FS zeroshift
Accuracy	±1% FS
Signal output	4-20 mA current loop
Temperature drift	0.05 % FS / °C
Material	AISI 304 stainless steel
Comp. temp. range	-35°C + 60°C

\*Including load distribution plate



OL2E Electro-hydraulic anchor load cell

SISGEO.COM



## ELECTRIC ANCHOR LOAD CELLS

Electrical resistance anchor load cells consist of a ring shaped stainless steel body which incorporates from 8 to 16 electrical resistance strain gauges in a full bridge configuration. The cell design minimizes the sensitivity to the eccentric load. A very stiff distribution plate is required, in order to ensure that the load is applied equally on the anular loading surface of the cell.

### AVAILABLE MODELS

OL204V03000	300 KN, ID 40 MM, OD 155 MM
OL205V05000	500 KN, ID 50 MM, OD 155 MM
OL207V05000	500 KN, ID 71 MM, OD 155 MM
OL207V07500	750 KN, ID 71 MM, OD 155 MM
OL211V07500	750 KN, ID 110 MM, OD 200 MM
OL212V10000	1000 KN, ID 120 MM, OD 220 MM
OL216V15000	1500 KN, ID 165 MM, OD 260 MM
OL219V18000	1800 KN, ID 190 MM, OD 300 MM
OL222V25000	2500 KN, ID 225 MM, OD 340 MM

Overload	1.5 X Full scale
Sensitivity	See calibration report
Accuracy Pol. MPE <sup>(1)</sup>	< ±0.5% FS
Thermal zero shift	< 0.005% FS / °C
Signal output	1.5 mV/V at FS 2.0 mV/V only for 2500 kN FS
Power supply	From 5V DC to 10V DC
Operating temp. range	-20°C +70°C
Comp. temp. range	-10°C +40°C
Body material	stainless steel 17-4 PH

### DISTRIBUTION PLATES

OL20040PD00	centre hole 40 mm, OD 110 mm
OL20050PD00	centre hole 50 mm, OD 110 mm
OL20071PD00	centre hole 71 mm, OD 110 mm
OL20110PD00	centre hole 110 mm, OD 155 mm
OL20120PD00	centre hole 120 mm, OD 180 mm
OL20165PD00	centre hole 165 mm, OD 210 mm
OL20190PD00	centre hole 190 mm, OD 250 mm
OL20225PD00	centre hole 231 mm, OD 290 mm

### ACCESSORIES

OECON07MV00	MIL male connector with cap
OELC420MA00	4-20 mA transmitter (2 wires)



## ELECTRO-HYDRAULIC LOAD CELLS

This model of load cells is used to monitor stresses in steel linings, struts, piles and support beams. They consist of a pressure pad with two handles connected to a pressure transducer; the pressure pad is composed by two stiff stainless steel plates saturated by de-aired oil. Special distribution plates are also available for better load distribution between two not-parallel surfaces.

### L2CE ELECTRO-HYDAULIC LC

OL2CE019000	1900 KN, OD 209 MM
Accuracy Pol. MPE <sup>(1)</sup>	< 1% FS
Signal output	4-20 mA current loop
Temp. operating range	from -20° to +80°C
Protection Class	IP 68 up to 100 KPa
Material	stainless steel
Power supply	from 9 to 30 V DC
Overall size (ODxLxH)	295 x 365 x 36,5 mm

OL2CE030000	3000 KN, OD 264.5 MM
Accuracy Pol. MPE <sup>(1)</sup>	< 1% FS
Signal output	4-20 mA current loop
Temp. operating range	from -20° to +80°C
Protection Class	IP 68 up to 100 KPa
Material	stainless steel
Power supply	from 9 to 30 V DC
Overall size (ODxLxH)	355x418x36,5 mm

### DISTRIBUTION PLATES

OL2CE200PD0	TWIN PLATES FOR 1.900 KN LOAD CELL, OD 200 MM
OL2CE252PD0	TWIN PLATES FOR 3.000 KN LOAD CELL, OD 252 MM

(1) MPE is the Maximum Permitted Error on the measuring range (FSR). In the Calibration Report, the accuracies of the gauge are calculated using both linear regression (≤ Lin. MPE) and polynomial correction (≤ Pol. MPE).

# EXTENSOMETERS & JOINTMETERS

\_TUNNELING

\_DAMS

\_HISTORICAL BUILDINGS

\_EMBANKMENTS

\_DEEP EXCAVATIONS

\_LANDSLIDES

\_BRIDGES AND VIADUCTS



## EMBANKMENT EXTENSOMETERS

Embankment (soil) extensometers are used to measure soil strains in large earth structures. The system consists of a number of anchor plates connected through extension rods to a VW displacement transducer. Connected to a data acquisition system, they provide an automatic real time monitoring and alerting.

### SYSTEM COMPONENTS

OD2320BM100	EXTENSION ROD, 1 M
OD2320BM200	EXTENSION ROD, 2 M
OD2320BM300	EXTENSION ROD, 3 M
OD111PV5500	PVC CORRUGATE
	ANTIFRICTION SLEEVE
OD232AN5000	ANCHOR PLATE, DIAM 500 MM
OD232AN5500	ANCHOR PLATE, 500 x 500 MM

### MEASURING ELEMENTS

OD232T050VW	50 mm (±25 mm) range
OD232T100VW	100 mm (±50 mm) range
OD232T150VW	150 mm (±75 mm) range
Type of sensor	vibrating wire transducer
Measuring range	50, 100, 150 mm
Sensitivity	<0.025% FS
Accuracy (MPE*)	< ±0.30% FS
Signal output	frequency (VW), resistance (T)
Typical frequency range	2250 - 3000 Hz
Operating temperature	-20°C +80°C
Material	stainless steel
Protection	IP68 up to 1.0 MPa
Signal cable	OWE104X20ZH

(\*) MPE is the Maximum Permitted Error on the measuring range (FSR). In the Calibration Report, the accuracies of the gauge are calculated using both linear regression (≤ Lin. MPE) and polynomial correction (≤ Pol. MPE).



## EMBEDMENT JOINTMETERS

Embedment jointmeters are usually installed across the joints in concrete dams in order to measure relative movement between two concrete blocks. Their design allows them to be installed directly onto the formwork. The internal VW displacement transducer is assembled at middle range allowing movements in both directions.

### AVAILABLE MODELS

OD314C025VW	VW EMBEDMENT JOINTMETER, 25 MM RANGE
OD314C050VW	VW EMBEDMENT JOINTMETER, 50 MM RANGE
OD314C100VW	VW EMBEDMENT JOINTMETER, 100 MM RANGE
OD314C150VW	VW EMBEDMENT JOINTMETER, 150 MM RANGE

### TECHNICAL CHARACTERISTICS

Type of sensor	vibrating wire transducer
Measuring range	25, 50, 100, 150 mm
Sensitivity	<0.025% FS
Total accuracy	< ±0.5% FS
Signal output	frequency (VW), resistance (T)
Operating temperature	-20°C +80°C
Material	stainless steel

## EMBEDMENT JOINTMETERS: INSTALLATION PROCEDURES

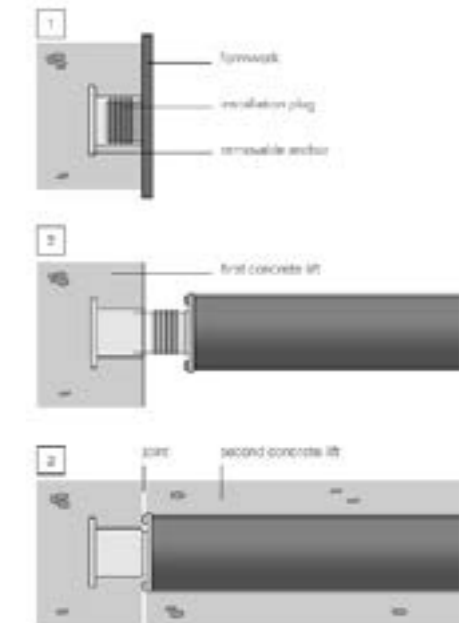

- 1 The removable anchor is embedded in the first pour. A plug keeps concrete out of the anchor.
- 2 After the plug is removed, the transducer body is screwed into the anchor and embedded in the second pour of concrete.
- 3 Now the instrument spans the joint between two blocks of concrete.

# EXTENSOMETERS & JOINTMETERS

\_TUNNELING

\_DAMS

\_HISTORICAL BUILDINGS

\_EMBANKMENTS

\_DEEP EXCAVATIONS

\_LANDSLIDES

\_BRIDGES AND VIADUCTS



## MULTIPOINT ROD EXTENSOMETER (MPBX)

Multipoint rod extensometers (MPBX) are installed in boreholes in order to monitor displacements at various depths using rods of different materials and lengths. A pre-set length of measuring rod is inserted into a nylon tube to avoid soil friction and its end is fixed to a steel groutable anchor. Displacements are read with linear transducers (DTE) or with a digital gauge.

### AVAILABLE MODELS

OD222AC00A0	s/steel or invar rods, DTE ≤ 100 mm
OD222AC00B0	s/steel or invar rods, DTE > 100 mm
OD222F600A0	fibreglass rods, DTE ≤ 100 mm
OD222F600B0	fibreglass rods, DTE > 100 mm
Number of bases	1 (single), from 2 to 6 (multiple)
Multiple head top tube	OD 120 mm
Extensometer rods	fibreglass pre-assembled stainless steel, 2 m sections
Protective sleeve	nylon 11 (rilisan), OD 12 mm

### GROUTABLE ANCHORS

Groutable anchors are supplied with all MPBX where packer anchors are not requested.

material	galvanized steel rebar
Diameter / length	Ø 16 mm / 400 mm (MPBX with fibreglass rods) Ø 22 mm / 400 mm (MPBX with stainless steel rods)

### PACKER ANCHORS

Two models of packer anchors are available, following different drilling diameter: 101 mm (4") and 127 mm (5"). If packer anchors are needed, the following products codes shall be added (max 4 packers for each extensometers):

OD222PKR127	PACKER ANCHOR for Ø 127 mm drillings (one for each measuring base)
-------------	--

(1) MPE is the Maximum Permitted Error on the measuring range (FSR). In the Calibration Report, the accuracies of the gauge are calculated using the linear regression; the error reported is the maximum residual error on the FSR.



## DISPLACEMENT TRANSDUCERS FOR MPBX

MPBX measurements can be taken manually with a depth micrometer or remotely through vibrating wire or 4-20mA displacement transducers and a readout or datalogger. Both vibrating wire and 4-20mA transducers are waterproof up to 1.0 MPa and output signals are suitable for long distance transmission.

### VIBRATING WIRE TRANSDUCERS

ODTE000VW00	VIBRATING WIRE DTE
Range	10, 25, 50, 100, 150, 200 mm
Signal output	frequency (VW), resistance (T)
Accuracy (MPE*)	< ±0.50% FS for 10 and 25 mm range < ±0.30% FS for 50 mm, 100, 150 and 200 mm range
Typical frequency range	2250 - 3000 Hz
Operating temperature	-20°C +80°C
Protection	IP68 up to 1.0 MPa

### POTENTIOMETRIC TRANSDUCERS

ODTE1A00000	LINEAR POTENTIOMETER DTE
Range	25, 50, 100, 150, 200 mm
Signal output	4-20 mA current loop
Accuracy (MPE*)	< ±0.30% FS for 25 mm range < ±0.20% FS for 50 and 100 mm range < ±0.15% FS for 150 and 200 mm range
Operating temperature	-20°C +80°C
Protection	IP68 up to 1.0 MPa

### ODIGD020000 DIGITAL GAUGE

The digital gauge kit consists of a depth caliper with LCD (readings in metric and imperial units), a set of extension rods and carrying case.

Range	from 0 to 200 mm
Resolution	0.01 mm
Temperature rating	0° C - 40° C
Humidity rating	≤ 80%



## MEXID EXTENSOMETER

MEXID are miniaturized MPBX extensometers that allow installation into a 50 mm diameter borehole. Displacement transducers are incorporated into the instrument head so, after positioning and grouting, the external encumbrance is that of the cable gland only (20 mm). Dedicated tubes allow grouting to fix the anchors to rock or soil.

### AVAILABLE MODELS

OD2MX00D000	fibreglass rods, Digital RS-485, available with 50 and 150 mm range
OD2MX00W000	fibreglass rods, vibrating wire sensors available with 50 and 150 mm range
OD2MX00A000	fibreglass rods, 4-20mA output <u>available only under request</u>
Number of bases	from 1 to 4 (2 to 4 for digital)
Signal output	4-20 mA current loop (On request) RS-485 Modbus RTU frequency (VW), resistance (T)
Accuracy MPE <sup>(1)</sup>	< ±0.20% FS (4-20mA output) ±0.20% FS (digital 50 mm range) ±0.15% FS (digital 150 mm range) ±0.30% FS (Vibrating wire)
Head diameter	48.3 mm
Head length	476 mm for 50 mm range 816 mm for 150 mm range
Extensometer rods	fibreglass, OD 7 mm
Protective sleeve	nylon 11 (rilisan), OD 12 mm
Groutable anchor	rebar 16 mm OD, 400 mm long

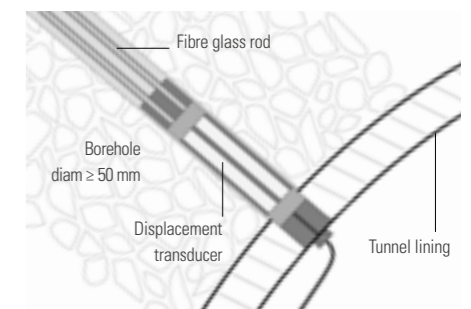

Project:  
Letlhakane Mine  
Botswana

SISGEO.COM

EXTENSOMETERS & JOINTMETERS 45

# EXTENSOMETERS & JOINTMETERS



- \_ TUNNELING
- \_ DAMS
- \_ HISTORICAL BUILDINGS
- \_ EMBANKMENTS
- \_ DEEP EXCAVATIONS
- \_ LANDSLIDES
- \_ BRIDGES AND VIADUCTS

Project:  
Cerro del Águila Dam  
Perú



## WIRE CRACKMETER

Wire crackmeter allows to monitor the changes in the distance between two anchor points located up to 30 m apart. The wire crackmeter consists of a stainless steel transducer box which includes the rotary electronic sensor with a wire tensioning device having 2 meter stroke. Typical application include measurements of large displacement associated with landslides.

### OD241A20000 WIRE CRACKMETER

Mechanical range	2000 mm (6.5")
Electrical range	240 mm (9.5") per complete rotation <sup>(1)</sup>
Accuracy	±1 mm (depends mainly from the thermal effects on the wire)
Repeatability	± 0.03 mm
Signal output	4-20 mA (current loop) for displacement, resistance for thermistor
Power supply	12-24 V DC
Operating temperature	-20°C +80°C
Wire diameter	Ø 2 mm, stainless steel
Max. wire tension	8 kg / 30 m long
Housing size and protection	380 x 270 x 160 mm (15 x 11 x 6.5"), IP65
Anchors	No. 4 SL M 8 expansion bolts (Ø 14 mm) for transducer housing No. 1 SL M 8 expansion eyebolt (Ø 14 mm) for opposing anchor

## ACCESSORIES

OD241W30EXT	WIRE EXTENSION KIT
OWE104K00ZH	4-WIRE SIGNAL CABLE
OEPDP004W00	OVERVOLTAGE PROTECTION

(1) A full rotation of potentiometer is about 240mm of displacement. Reading resets to zero after each rotation.  
(2) MPE is the Maximum Permitted Error on the measuring range (FSR). In the Calibration Report, the accuracies of the gauge are calculated using both linear regression and polynomial correction (≤ Pol. MPE).

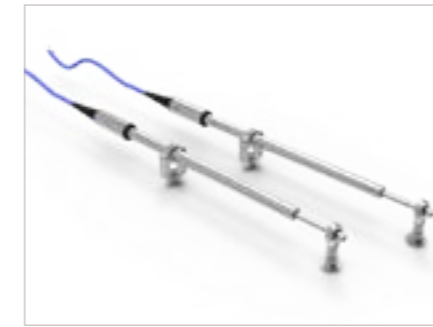

## ELECTRICAL AND VW CRACKMETERS

Crackmeters and jointmeters are utilized to monitor movements of surface cracks and joints in concrete structures or rock. The displacement transducer housed in the sensor body is positioned across the joint/crack which enables the measurement changes in distance between the anchors.

### ELECTRICAL CRACKMETERS OD313SA

Technology	Linear potentiometer
Range	0 - 10/25/50/100/150/200 mm
Accuracy Pol. MPE <sup>(2)</sup>	< ±0.50% FS for 10 mm range < ±0.30% FS for 25 mm range < ±0.20% FS for 50/100 mm ranges < ±0.15% FS for 150/200 mm ranges
Output signal	4-20 mA current loop (voltage on request)
Power supply	12-24V DC
Operating temperature	-20°C +60°C
Sensor diameter	16 mm
Material	stainless steel
Protection	IP68 up to 100 kPa

### VIBRATING WIRE CRACKMETERS OD313S

Technology	vibrating wire with built-in thermistor
Range	0 - 25/50/100/150 mm
Accuracy Pol. MPE <sup>(2)</sup>	< ±0.50% FS for 25mm range < ±0.30% FS for other ranges
Output signal	frequency (VW), resistance (T)
Typical frequency range	1500 - 2800 Hz
Operating temperature	-20°C +80°C
Body diameter	16 mm
Material	stainless steel
Protection	IP68 up to 100 kPa

## ACCESSORIES

OD31Y1DTE00	Y-AXIS STAINLESS STEEL FIXING KIT
OD31Z1DTE00	Z-AXIS STAINLESS STEEL FIXING KIT

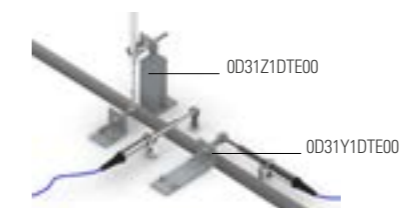

## 3-D MECHANICAL CRACKMETER

3-D (triaxial) mechanical jointmeters are aimed to monitor joints and cracks. The movements between the two anchors are obtained by mechanical dial gauges. Simple and inexpensive, the tell-tale crack monitor, installed across a fissure, allows the crack survey in two directions.

### AVAILABLE MODELS

OD3103D3000	3-D CRACKMETER ASSEMBLY
Mechanical range	0 - 30 mm for each axis
Base lengths	200 mm (3-D)
Anchors	2 groutable rebar Ø 16 mm, length 80 mm
Material	Stainless steel and aluminium

### DIAL GAUGE KIT

ODIG30KIT00	Dial gauge is used for manual readings of the uniaxial and triaxial crackmeters. It includes: gauge with standard 0.01 mm division, 30 mm measuring range, steel collar, fitting device, carrying case
Measuring range	0 - 30 mm
Gauge resolution	0.01 mm
Gauge accuracy	±0.05 mm

### TELL-TALE CRACK MONITORS

OD300LINE00	wall / flat surfaces
Model	biaxial
Mechanical range	±20 mm (X-axis), ±10 mm (Y-axis)
Material	acrylic resin
OD300CORN00	crack on corner or between wall and floor
Model	biaxial
Mechanical range	±20 mm (X-axis), ±10 mm (Y-axis)
Material	acrylic resin



OD300LINE00 OD300CORN00

# STRAIN-GAUGES & THERMOMETERS

\_PILES AND MASS CONCRETE

\_CONCRETE STRUCTURES,  
BEAMS AND COLUMNS

\_CONCRETE FOUNDATIONS  
AND DIAPHRAGM WALLS

\_TUNNEL SEGMENTS

\_STEEL STRUCTURES, PIPES  
AND ARCH SUPPORTS

\_GRAVITY AND ARCH DAMS

\_BRIDGES AND VIADUCTS



## VIBRATING WIRE STRAIN-GAUGES

Vibrating wire strain-gauges are used to monitor variation in strain, which allows stress evaluation in steel or concrete structures. A thermistor incorporated into the gauge gives the temperature at the point of measurement allowing temperature compensation. 3-D rosette mounting is also available.

### AVAILABLE MODELS

OVK4000VS00	WELDABLE SG
OVK4000VSCO	CONCRETE SURFACE SG
OVK4200VC00	EMBEDMENT SG
OVK4200VCHP	EMBEDMENT SG FOR DEEP APPLICATION
OVK4000SM00	SHOTCRETE SG WITH ADJUSTABLE TENSIONING
Range (nominal)	3000 $\mu\epsilon$ (shotcrete 10000 $\mu\epsilon$ )
Signal output	Frequency (strain), Ohm (temperature)
Accuracy	$\pm 0.5\%$ FS ( $\pm 3\%$ FS for OVK4000SM00)
Repeatability	$\leq \pm 1 \mu\epsilon$ , $\leq \pm 3 \mu\epsilon$ for OVK4000SM00
Coil resistance (nominal)	150 ohm
Embedded thermistor type	NTC 3 k $\Omega$
Temperature range	-20°C + 80°C

### ACCESSORIES

OVK42VC3D00	3D rosette mounting block for embedment strain gauges.
OVK400JIG00	Spacing jig for mounting the arc-weldable strain gauges end blocks.
OVK400MB200	Pair of arc-weldable surface mounting blocks.
OVK400COVER	S/steel protective cover with lugs and pair of weldable blocks

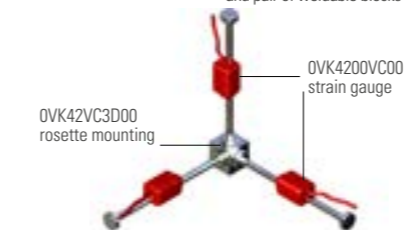

VW strain gauges in 3D configuration



## SPOT WELDABLE STRAIN GAUGES

Vibrating wire spot-weldable strain gauges are mainly designed to measure strain on steel surfaces. They consist of a weldable SG and a cover which contains the plucking coil. SG is pre-tensioned during manufacturing at mid range. SG installation is preferred using the spot welder recommended by the manufacturer.

### OVK4100VS00 SPOT WELDABLE SG

Active gauge length	47.5 mm
Range (nominal)	500 $\mu\epsilon$ to 3500 $\mu\epsilon$
Signal output	frequency (VW), resistance (T)
Sensitivity <sup>(1)</sup>	1.0 $\mu\epsilon$
Accuracy <sup>(2)</sup>	$\pm 0.5\%$ FS
Stability	0.1% FS/year
Typical frequency range <sup>(3)</sup>	from 1130 to 3000 Hz
Coil resistance	150 Ohm
Thermistor type	NTC 3 k $\Omega$
Thermal coeff. of expansion	12.0 ppm / °C
Temperature range	-20°C a +80°C

- (1) Using a gauge factor, the measured frequency can be converted directly into units of strain  
 (2) With batch calibration  
 (3) The expressed frequency range could have a  $\pm 10\%$  variation

### OVK4100VSPO PLUCKING COIL

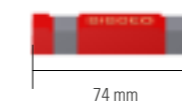

74 mm

### OVK4100VSGO STRAIN GAUGE ONLY

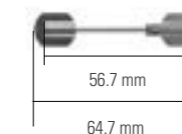

56.7 mm

64.7 mm

### ACCESSORIES AND COMPONENTS

OWE104SG0ZH	LSZH signal cable
OVK4100VSGO	Strain-gauge only
OVK4100VSPO	Plucking coil only

## EXAMPLE OF EARTH PRESSURE CELLS INSTALLATION

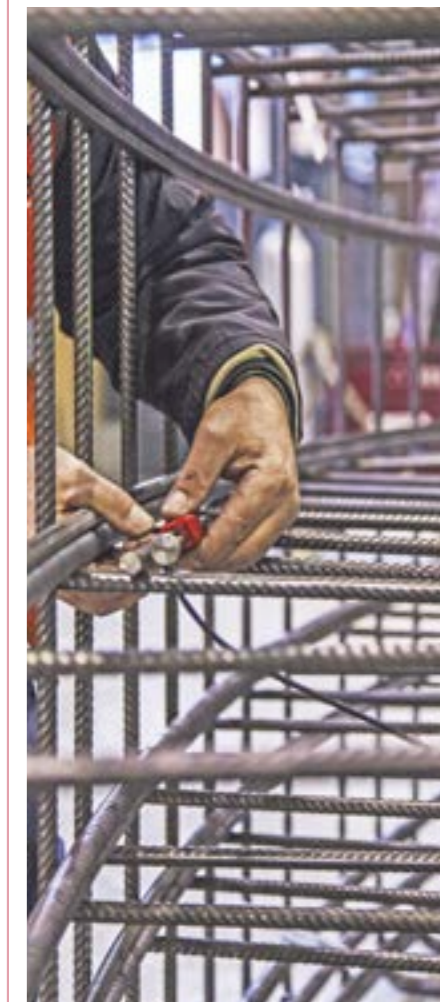

TELT - Tunnel Euralpin Lyon Turin, installation of VW strain gauges within TBM precast concrete element.

## \_PILES AND MASS CONCRETE

## \_CONCRETE STRUCTURES, BEAMS AND COLUMNS

## \_CONCRETE FOUNDATIONS AND DIAPHRAGM WALLS

## \_TUNNEL SEGMENTS

## \_STEEL STRUCTURES, PIPES AND ARCH SUPPORTS

## \_GRAVITY AND ARCH DAMS

## \_BRIDGES AND VIADUCTS



### EMBEDMENT THERMOMETERS

Temperature is a very important parameter to measure, so as the evaluation of the influence of thermal effects on the recorded data associated with the structure being monitored. Sisgeo uses three types of technologies to monitor temperature: thermistors, RTDs (Resistance Thermal Detectors) and vibrating wire sensors.

#### OT111PT1000 PT100 THERMOMETERS

Measuring principle	RTD, 100Ω (PT-100) (Class A EN60751)
Nominal range	-200°C +400°C
Resolution	0.1°C
Accuracy	±0.2 °C @ 0°C
Diameter	20 mm
Length	100 mm
Body material	stainless steel

#### OT3800GKA00 THERMISTORS

Measuring principle	NTC, thermistor
Nominal range	-40°C +125°C
Resolution	0.1 °C
Accuracy	±0.5 °C (from 0°C to 50°C)
Diameter	12 mm
Length	55 mm
Body material	stainless steel

#### OT2200VW000 VW THERMOMETER

	(available only on request)
Measuring principle	Vibrating wire + NTC
Nominal range	-20°C +80 °C
Resolution	0.1 °C
Accuracy	±1.0 °C
Diameter	20 mm
Length	166 mm
Body material	stainless steel



### TEMPERATURE STRINGS

Temperature strings are often used to monitor the thermal profile in boreholes or mass concrete temperature during curing. They consist of a RTD or thermistor sensors mounted on a length of multicore cable. The spacing between two sensors is customized according to Client requests.

#### OTS00RTD000 RTD STRINGS

Type of sensor	RTD 100 Ω (PT-100) (Class A EN60751)
Number of sensor	until N.4 with OWE1160LSZH cable until N.8 with OWE1320LSZH cable
Nominal range	-200°C +400°C
Accuracy	±0.2 °C @ 0°C
Sensed section	PVC, length 180 mm, Ø 28 mm
Temperature range	-30°C +80°C with standard cable
IP Class	IP68 up to 2.0 MPa

#### OTS00NTC000 THERMISTOR STRINGS

Type of sensor	NTC thermistor
Number of sensor	until N.8 with OWE1160LSZH cable until N.16 with OWE1320LSZH cable
Nominal range	-40°C +125°C
Accuracy	±0.5 °C (from 0°C to 50°C)
Sensed section	PVC, length 180 mm, Ø 28 mm
Temperature range	-30°C +80°C with standard cable
IP Class	IP68 up to 2.0 MPa

#### CABLES FOR TEMPERATURE STRINGS

OWE1160LSZH for OTS00NTC000 for OTS00RTD000	MULTICORE CABLE No. 4 or 8 measuring points No. 4 measuring points
OWE1320LSZH for OTS00NTC000 for OTS00RTD000	MULTICORE CABLE No. 12 or 16 measuring points No. 8 measuring points

- \_ARCH DAMS
- \_CONCRETE DAMS
- \_SKYSCRAPERS
- \_SLENDER STRUCTURES
- \_BELL TOWERS
- \_MINARETS

Project:  
Emenek Dam  
Turkey



## DIRECT AND INVERTED PENDULUMS

Direct and inverted pendulums are simple, reliable and accurate systems used to monitor horizontal movements. Commonly utilized in concrete dams, they permit to measure the change in verticality. The inverted pendulum anchored in the foundation combined with the direct pendulum allow to obtain a complete profile of the dam's verticality.

### OS911002500 DIRECT PENDULUM

The direct pendulum is a gravity-referenced instrument. It consists of:

- stainless steel cylindrical fluid tank with cover
- wire tensioning weight and damping unit
- upper wire anchor system with rail and sliding block
- turnbuckle for trimming the damping unit position

Tank dimensions	410 mm diam, 415 mm high
Material	stainless steel
Damping fluid (mineral oil)	not supplied

### OS912006000 INVERTED PENDULUM

The inverted pendulum provides a fixed datum from which structural movements can be measured. It consists of:

- stainless steel anular damping chamber with cover
- stainless steel floating unit
- adjustable tie bar with 100 mm vertical stroke
- external tube for liquid level survey
- steel ballast for borehole wire anchoring

Tank dimensions	615 mm diam, 497 mm high
Floating unit	allows $\pm 72$ mm movement in any direction
Groutable anchor diameter	75 mm, adjustable from 80 mm to 160 mm by centralized pins, steel.
Material	stainless steel
Damping fluid (mineral oil)	not supplied

### OWRAC200000 PENDULUM WIRE

Material	stainless steel
Diameter	2 mm

SISGEO.COM



## T-1000 TELEPENDULUM

T-1000 Telependulum is designed to take automatic readings of the coordinates of pendulum's plumb lines. Thanks to the new optic sensor without any moving parts, it has very high accuracy and resolution and wide measuring range. T-1000 can be settled and read locally with dedicated mobile APP or can be integrated into automatic data acquisition system networks through RS485 or 4-20mA output.

### O TELT100000 TELEPENDULUM

Measurement principle	optical (without moving parts)
Measurement range	X-axis: 0-150 mm ( $\pm 75$ mm) Y-axis: 0-150 mm ( $\pm 75$ mm)
Resolution	0.01 mm
Repeatability (both axis):	
in core area <sup>(1)</sup>	$\pm 0.02$ mm
whole measuring area <sup>(1)</sup>	$\pm 0.05$ mm
Accuracy Pol. MPE <sup>(1)</sup>	
in core area <sup>(1)</sup>	
for movements < 30mm	$\pm 0.05$ mm for both axis
in meas. area <sup>(1)</sup>	
for movements < 30mm	$\pm 0.10$ mm for both axis
in meas. area <sup>(1)</sup>	
for movements $\geq 30$ mm	$\pm 0.25$ mm ( $\pm 0.15\%$ FS) for both axis
Stability @60 hours	$\pm 0.05$ mm
Detectable wire (diameter)	from 0.8 mm to 2 mm best performance with 1 mm wire
Output:	
- Local readings	Mobile APP through Bluetooth 4.2
- Remote monitoring	RS-485 with Modbus RTU protocol <sup>(1)</sup> 4-20mA 4-wires

### T-1000 APP



Diagnostic parameters output page

<sup>(1)</sup> Refer to T-1000 datasheet technical specifications notes



## OPTICAL PENDULUM READOUT

The pendulum readout (coordinometer) is a reliable and simple instrument for manual readings of pendulum systems. It allows calculation of the horizontal movements of the pendulum wire and a digital LCD displays the X and Y coordinates in millimetres. It can be utilized for either in-place installation or removable measurements in different locations.

### OS9RTB15000 MANUAL READOUT

Measurement area	X-axis: 0-150 mm ( $\pm 50$ mm) Y-axis: 0-150 mm ( $\pm 50$ mm)
Gauge resolution	0.01 mm
Gauge accuracy	$< \pm 0.1$ mm
Gauge protection	IP67
Temp. operating range	-20°C +60°C
Material	aluminium
Dimensions	340 x 340 x 115 mm
Weight	3.5 kg

### ACCESSORIES

OS9RTPLT100	SUPPORT BASE PLATE
Material	galvanized steel
Dimensions	415 x 415 x 10 mm (LxWxH)
OS9RTFR1000	CALIBRATION FRAME
Material	stainless steel /aluminium
Overall dimensions	204 x 120 x 98 mm (LxWxH)

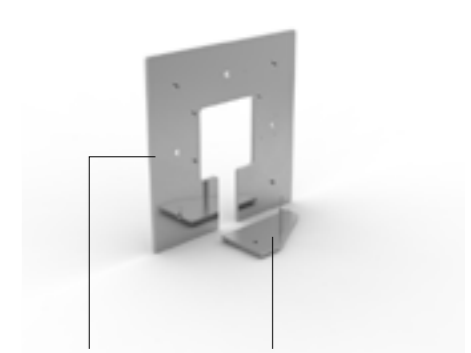

OS9RTPLT100 OS9RTFR1000



## MIND READOUT

MIND is an innovative readout, compatible with both digital and analogue instruments. It is designed in order to be rugged, flexible and to obtain fast and precise readings. Internal diagnostic sensors (temperature, humidity and battery voltage) help the user to control the health of the readout during the usage.

### OMIND000000 MIND READOUT

Type of measurements	mA, mV, mV/V, V, °C, VW, RS-485 Modbus RTU
A/D conversion	Resolution: 24bit, modulation method sigma-delta
Material	aluminum
IP class	IP65
Overall dimensions	205x128x45 mm
Weight	1 Kg
Operative temperature	-30 to +70 °C (battery -20 to +60°C)

Detailed electrical characteristics available on MIND datasheet

### SPARE PARTS AND ACCESSORIES

0ECAV08V2J0	Jumper cable with 2 connectors for reading connectorized instruments
0ECAV08V2S0	Switch jumper cable with 2 connectors for switch panels and measuring boxes
0ECAV8P6A00	7-clips jumper cable with 6 alligator clips for instrument reading
0ECABMIND00	Battery charger Input volt. 90-264 Vac, 50-60 Hz IP41 Max output power 10 W
0ECABMINDMU	MUX box to MIND cable Jumper cable for direct connection from MIND to multiplexer boxes.



## MIND APP MAIN FEATURES

- Automatic configuration of sensors through QRcode
- Simultaneous display of electrical and engineering measures
- Real time charts
- Quick read for immediate readings without configuration
- Geolocation of sites and sensors
- Multiplexers reading
- Digital chains reading
- Biaxial analogue sensors reading with the simultaneous reading of temperature
- Search engine for sites and sensors
- Spectrum Analyzer on board for vibrating wire sensors analysis



MIND App compatible with:  





## CRD-400 MULTIPURPOSE READOUT

CRD-400 is a new generation multipurpose readout designed to take readings of all instruments including vibrating wire. CRD-400 permits readings in both electrical and engineering units. Battery level, readout temperature and date are always displayed. CRD-400 comes with shoulder/belt bag, battery charger, sensor cable with 6 alligator clips and USB flash drive with user manual.

### CRD-400 READOUT

Type of measurements	mA - mV - V - mV/V - °C - Hz (µsec - digit - µε)
A/D converter	24 bit Sigma-Delta (22 true-bit)
Display	Amorphous silicon TFT LCD panel with LED backlight unit, 320 x 240, 3.5", sunlight reliability
Reading resolution	1µA at FS 20mA - 1µV at FS ±20mV - 10µV at FS ±1V - 100µV at FS ±10V - 0.001mV/V at FS 10mV/V - 0.1°C for PT100 - 0.1°C for NTC
Accuracy	0.1 Hz at FS from 400 to 6000Hz 0.01% FS (0.1% for Voltage and Servo-inclinometer, 0.2% FS for PT100 and NTC
Rechargeable battery	4 x AA NiMH, 2450 mAh
Environmental	-20°C +60°C, IP67
Dimensions and weight	100 x 230 x 45 mm, 0.5 Kg

### SPARE PARTS AND ACCESSORIES

0ECABCRD400	Battery charger 100-240 V AC input 12 V DC output
0ECAV8P6A00	Clips jumper cable with 6 alligator clips for instrument reading
0ECAV08V2S0	Jumper cable with 2 connectors for reading connectorized instruments
0ECAV08V2S0	Switch jumper cable with 2 connectors for switch panels and measuring boxes



Project:  
San Leo Rockfall  
Italy



## OMNIALOG DATALOGGER

OMNIALog is a web-based datalogger designed for geotechnical and structural monitoring applications. OMNIALog offers extensive measurements and control functionality; it is supported by a selection of communication options. On-board keyboard/display and external storage using USB flash drive are also included. OMNIALog doesn't require any proprietary software and stored data can be sent to the user FTP server or email address.

### OMNIALOG

OMNIALOG GT-2400	24 channel on board + RS485
OMNIALOG GT-100D	RS485 input
Processor	ARM Cortex M3, 120 MHz CPU, 1MB RAM
Mass storage	SD CARD 32 GB (*) and WEB pages
Analog inputs	24 differentials individually configured. Channel expansion provided by Sisgeo multiplexers. (OMNIALOG GT-2400)
Digital inputs	N.2 opto-isolated Two opto-isolated digital inputs individually selectable for switch closure, high frequency pulse and trigger. Independent 32-bit counters for each input. Max Input Voltage: 24V (Max Current: 10mA) Min Input Voltage: 5V (Max Current: 2mA) $\pm 0.01\%$ FS (0.1% FS for NTC and PT100)
Reading resolution (OMNIALOG GT-2400)	1 $\mu$ A at range 20 mA 10 $\mu$ V at range $\pm 100$ mV - 100 $\mu$ V at range $\pm 1$ V 1 mV at range $\pm 10$ V - 0.1 $^{\circ}$ C for Pt100 - 0.1 $^{\circ}$ C for NTC 0.1 Hz at range 6000 Hz - 0.001 mV/V at range $\pm 10$ mV/V
Measurement accuracy	0.01% F.S. (0.1% F.S. for Pt100 and NTC) with Standard measurement Calibration in Sisgeo laboratories recommended every 2 years.
On-board sensors	Temperature measured on the electronic board (accuracy $\pm 1\%$ )
Operating temperature	-30 to +70 $^{\circ}$ C (display -20 to +70 $^{\circ}$ C)
Dimensions (L x W x H)	183 x 144 x 118 mm OMNIALOG GT-2400 183 x 144 x 76 mm OMNIALOG GT-100D



## OMNIALOG CABINETS

The versatility and the flexibility of OMNIALog allow customized systems to meet the Client needs and the project requirements. A variety of "cabinet" with internal relay multiplexers are offered in order to expand the number of channels (sensors) managed by one datalogger. Each channel can be independently configured minimizing the number of multiplexer.

### COMPONENTS AND ACCESSORIES

00MNCAB2000	IP65 cabinet, polycarbonate, 500x400x200mm, ready for max No.2 MUX digital power supply kit and comm interface
00MNCAB3000	IP65 cabinet, stainless steel, 600x400x250mm, ready for max No.3 MUX, digital power supply kit and comm interface
00MNCAB8000	IP65 cabinet, stainless steel, 600x600x250mm, ready for max No.8 MUX, digital power supply kit and comm interface
00MN24MUX00	MUX board, 24 channels, overvoltage protections on every channel
00MN24V100W	Additional kit for digital instruments including DC/DC 12/24V 100W power supply and No.4 input wiring board

### MAIN COMMUNICATION INTERFACES

00MXROUTVFN	HSPA 3G router with VPN service Is the fastest and easy way for remote OMNIALog managing and data download.
00MXFOMMSWT	Optical fiber interface (available only on request) Switch ethernet with multimode optical fiber ports for in/out (Available only on request).



## REMOTE MULTIPLEXERS

Multiplexer boxes offer a valid alternative to OMNIALog cabinets when a distributed sensor network is preferred. The relay multiplexer boards, mounted inside an IP67 box, operate as peripheral units; they are connected through a RS485 bus to a remote OMNIALog datalogger. Remote multiplexers can be used as terminal boxes, reading them with MIND readout.

### COMPONENTS AND ACCESSORIES

00MN24MUXB0	MUX box, 24 channels inputs polycarbonate enclosure, 300x300x180mm overvoltage protections on every channel
00MN48MUXB0	MUX box, 48 channels inputs polycarbonate, 300x300x180mm overvoltage protections on every channel
0WE610MUXZH	Connecting cable from MUX to MUX or from MUX to OMNIALog datalogger
00MX4MUXEXT	External MUX connection board for maximum No.4 external MUX.
0AXB022000	IP67 power supply kit AC/DC charger, Vin 85-265 Vac 50-60Hz, Vout 13.2V / 0.9A.
0AXB0W100AH	Solar power supply package available in different model, including panel, battery and charge controller.

### AIDA IOT WEB DATA PLATFORM

AIDA IOT is a full-featured, web-based platform for the real-time management, processing and visualization of monitoring data from all sensor types. Through its web pages, the data are at any time available to the user in graphical and tabular formats. Discover more: <http://www.aidaiot.com/>



# READOUTS, DATALOGGERS & ACCESSORIES



## SENCEIVE SENSOR INTERFACE RANGE

Connect a wide range of geotechnical and structural sensors into wireless remote monitoring systems.

### SENCEIVE DIGITAL INTERFACE NODE

A robust IP66/IP67 rated digital data logger that transforms your data collection from manual to automated sampling. This wireless digital data logger enables a simple connection to the Senceive back-end & front-end platforms. Interact and manage your data online and change reporting times and thresholds remotely.

### NODES

Automate data collection by integrating a wide range of vibrating wire sensors into Senceive's wireless networks. It allows engineers and asset managers to capture high-resolution data from sensors in remote or hazardous locations without the need for manual site visits.

### SENCEIVE GATEWAYS

0EGSM0K0200 FLATMESH 4G GATEWAY

0EGSM0K1000 GeoWAN 4G Gateway



## READOUT ACCESSORIES AND SPARE PARTS

In order to simplify installation and reading procedures, Sisgeo offers a variety of accessories to meet all the Client requirements such as cable splicing kits, connectors, cable end protections, etc... Cable splicing kits permit to make cable joints at site by means of bi-component epoxy resin.

### ACCESSORIES

0EGSM0K0200	CABLE SPLICING KIT (2 TUBES) with caps and epoxy resin
0EGSM0K1000	CABLE SPLICING KIT (10 TUBES) with caps and epoxy resin
1000RES2COR	BI-COMPONENT EPOXY RESIN 0,5 Kg pack
0EC0N07MV00	FLYING MIL CONNECTOR AND CAP 7 PIN male MIL connector
0EPD023IPID0	JUNCTION BOXES 2/3 inputs
0EPD0300000	SIMPLE JUNCTION BOXES 3 instrument cables
0EPD0600000	SIMPLE JUNCTION BOXES input 6 instrument cables
0EPD1000000	SIMPLE JUNCTION BOXES input 10 instrument cables
0EPDP002W00	COMPLETE OVP JUNCTION BOXES input 1 cable
0EPDP004W00	COMPLETE OVP JUNCTION BOXES input 1 or 2 cables
0EPC0661S00	TERMINAL BOXES input up to 6 instruments
0EPC1262S00	TERMINAL BOXES input up to 12 instruments
0EPC1863S00	TERMINAL BOXES input up to 18 instruments
0EPC2464S00	TERMINAL BOXES input up to 24 instruments
0EC0N07MV00	MALE MILITARY CONNECTOR
0EC0N07FV00	FEMALE MILITARY CONNECTOR
0EC0N07MP00	MALE BULKHEAD MILITARY CONNECTOR
0EC0N07FP00	FEMALE BULKHEAD MILITARY CONNECTOR

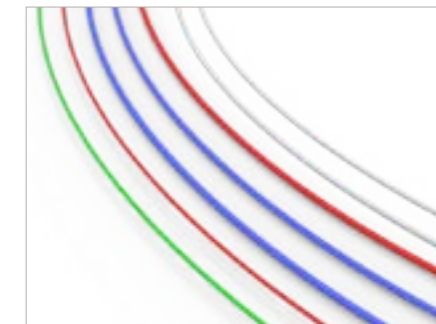

## SIGNAL AND MULTICORE CABLES

Sisgeo cables are designed for a variety of geotechnical and hydro-geological applications and can be embedded in concrete or buried in the soil. All Sisgeo signal and multicore cables have LSZH (Low Smoke Zero Halogen) jackets according to the latest required standards.

### STANDARD CABLES

0WE104K00PV	PVC SIGNAL CABLE 2 twisted pairs - 22 AWG
0WE104SG0ZH	LSZH SIGNAL CABLE 2 twisted pairs - 22 AWG
0WE104X20PV	PVC ARMoured SIGNAL CABLE 2 twisted pairs - 22 AWG
0WE203KE0ZH	LSZH VENTED CABLE 2 conductors - 20 AWG nylon tube (ID/OD 1.4/2.4 mm)
0WE205KE0PV	PVC VENTED CABLE 2 conductors - 24 AWG nylon tube (ID/OD 1.4/2.4 mm)

### SPECIAL CABLES

0WE102KE0ZH	LSZH SIGNAL CABLE 2 conductors - 20 AWG
0WE104PH100	CABLE FOR TITANIUM PIEZOMETERS 2 twisted pairs - 22 AWG
0WE1060LSZH	LSZH SIGNAL CABLE 6 conductors - 24 AWG
0WE1061POZH	LSZH SIGNAL CABLE 6 conductors - 24 AWG
0WE6061PDZH	LSZH DIGITAL SENS. ELONG. CABLE 2 TWISTED PAIRS - 1 TWISTED PAIRS
0WE1160LSZH	LSZH MULTICORE CABLE 8 twisted pairs - 24 AWG
0WE1320LSZH	LSZH MULTICORE CABLE 16 twisted pairs - 24 AWG
0WE610MUXZH	EXTERNAL MUX-OMNIA CABLE 4 twisted pairs - 2-conductors pairs
0WE116000PV	PVC MULTICORE CABLE 8 twisted pairs - 24 AWG
0WE132000PV	PVC MULTICORE CABLE 16 twisted pairs - 24 AWG

0WE104K00ZH, 0WE104X020ZH, 0WE132XLSZH and 0WE116XLSZH on request.



Project:  
Karahnjukar HPP  
Iceland



Project:  
Karahnjúkar HPP  
Iceland



## SISGEO RAIL®

The railway sector deserves the most advanced surveillance solutions to guarantee the highest level of safety.

SISGEO RAIL® is the specialized brand of the SISGEO Group dedicated to the railway industry and rail monitoring solutions. The mission is to actively participate in the digitization of worldwide rail infrastructure providing unique value through both cabled and IoT monitoring solutions.

Thanks to the recognized experience of SISGEO in the field of structural and geotechnical instrumentation, through large investments in innovation and R&D, SISGEO RAIL® is able to meet the industrial and technological challenges linked to the development of this strategical and environmentally friendly transportation mode that is the train.

- (1) Repeatability error calculated as maximum error of ten repetition of measuring points at 10% and 90% FSR.  
 (2) Sensitivity is a specific parameter different for every gauge. The sensitivity is calculated during gauge calibration test and inserted into the Calibration Report.  
 (3) MPE is the Maximum Permitted Error on the measuring range (FSR). In the Calibration Report, the accuracy of the gauge is calculated using the linear regression.

SISGEO.COM



## WIRELESS FLX-RAIL® RAIL SWING MONITORING

FLX-Rail®, specially developed for the railway swing monitoring, automatically and continuously measures the maximum vertical deformation of the rail at each train passage. This phenomenon is commonly known as "rail swing" or "rail dance". The instrument is installed between the track and the ballast, fixed under the rail using two powerful magnets for a quick and easy installation.

### SBV® TECHNOLOGY

SBV® is a revolutionary technology specially developed for railway monitoring instrumentation which aims to activate the measuring devices only when needed.

### MODELS

0DFLXS7000T	Wireless FLX-Rail®, non rechargeable, vertical displacement range 70 mm
RFLXWD70300	Wireless FLX-Rail®, non rechargeable, vertical displacement range 70 mm tilt $\pm 15^\circ$
RFLXWR70000	Wireless FLX-Rail®, rechargeable, vertical displacement range 70 mm
RFLXWR70300	Wireless FLX-Rail®, rechargeable, vertical displacement range 70 mm

### DYNAMIC DEFLECTION SENSOR

Sensor type	Optic
FS and Measuring range	70 mm
Sensor resolution	0.01 mm
Reading frequency	350 Hz
Offset temperature dependency	0.03 mm/°C
Sensor repeatability	$\pm 0.01$ mm
Sensor 24 hours stability <sup>(1)</sup>	$\pm 0.1$ mm
Sensitivity <sup>(2)</sup>	See Calibration Report
Sensor accuracy (MPE) <sup>(3)</sup>	$< \pm 0.1$ mm



## RDS RAILWAY DEFORMATION SYSTEM

RDS, Railway Deformation System, is a unique monitoring system designed by Sisgeo for the automatic surveying of the rail tracks longitudinal deformation and the sleepers rotation. The rail track geometry is monitored in terms of longitudinal level and torsion of the track.

### ADDITIONAL INFORMATIONS

FIELD S.r.l., as part of Sisgeo Group, has developed AIDA IoT, a dedicated service for data/measurement management for automatic and manual monitoring systems. Measurements provided by the FLX-Rail® are sent through LoRaWAN and then forwarded to a dedicated server. AIDA IoT organizes data and provide both graphical and tabular views. The AIDA IoT platform provide nearly real-time charts, showing both maximum displacement, inclinations and temperature. Also complex calculations can be displayed on specific chart. For further information, visit the dedicated website: <http://www.aidaiot.com/>



This AIDA IoT screenshot shows the histogram with the maximum displacement for each train passage. Enlarging the zoom makes possible to verify at which time the train has passed on the FLX-Rail® installation point, as well as the corresponding maximum vertical displacement reading.



This plot shows short twist from pairs of FLX-Rail® installed 3m apart.



In construction underground, where the engineer deals with materials having properties that vary not only in space but also in time, details of construction often have significant or even overwhelming influence on the behavior of the structure and of the surrounding soil. For an understanding of the behavior, these details must be observed and recorded.

***Ralph B. Peck (1972)***

Courtesy of CENTENO RODRIGUEZ & ASOCIADOS S.C.





SISGEO S.R.L.  
VIA F. SERPERO 4/F1  
20060 MASATE (MI) ITALY  
PHONE +39 02 95764130  
FAX +39 02 95762011  
INFO@SISGEO.COM

WWW.SISGEO.COM