



— DELIVERING
SOLUTIONS

 CATALOGUE



— **GEOTECHNICAL INSTRUMENTS
AND STRUCTURAL HEALTH MONITORING**

COMPANY PROFILE





EXPERIENCE AND INNOVATION

SISGEO was founded in 1993 inheriting the abilities of "SIS Geotecnica", the leading company in Italy in geotechnical engineering. Over the years, SISGEO has distinguished itself internationally thanks to a tight and highly motivated working group, that devoted itself with passion and creativity to design and manufacture high quality instruments to meet the broader needs in the field of civil engineering.

Experience is the solid foundation from which we start to develop our products and services with a constant focus on continuous innovation and attention to the sector's future needs. Over the years, SISGEO has become a recognized brand for quality, reliability and innovation.

1



Experience is the solid foundation from which we start to develop our products and our services with a constant focus on continuous innovation and attention to the sector's future needs

MADE IN ITALY



SISGEO is based in Masate, in the industrial area located east of Milan. A three storey building of more than 2.000 sq.m, with offices, laboratories, manufacturing department, warehouse and a separate building dedicated to the production of fibreglass extensometers and over 500 sq.m of outside area for exclusive use.

"Made in Italy" is the heart of our business and at the same time a legacy of history, creativity, style and passion we are proud to bring to the world with our products and services, through a network of international engineers with proven skills.

1 **VK40** vibrating wire strain gauges



WE DELIVER THE FUTURE

We listen to the earth with our instruments and we respect it with our manufacturing processes designed to reduce any environmental impact.

"Tracciamo soluzioni" (delivering solutions) is how we introduce ourselves because it is what we do, giving prominence to people. Acquiring skills and taking note of the ideas of those who work with us, enable ourselves to satisfy our Clients' needs. This is the basis on which we trace our route. Planning, design and build are our ways to improve and simplify the work of our Clients. We believe that the interaction between Clients and ourselves is essential to feed our experience and stimulate our creativity.

We listen to the earth with our instruments and we respect it with our manufacturing processes designed to reduce any environmental impact.

2

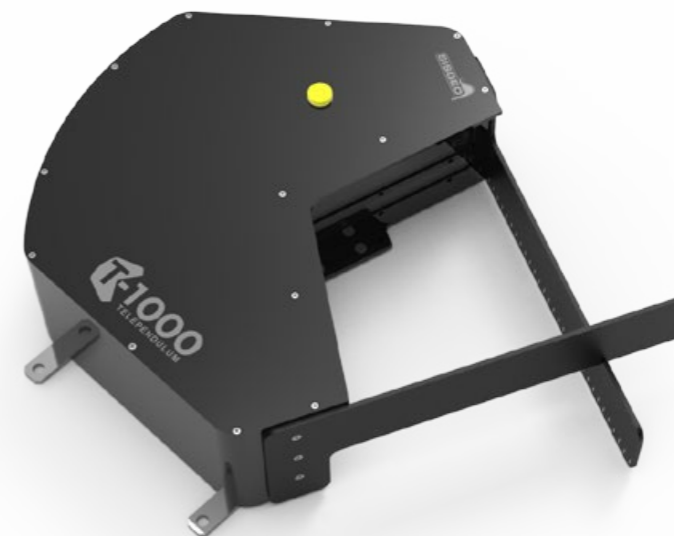

2 **T-1000** telependulum

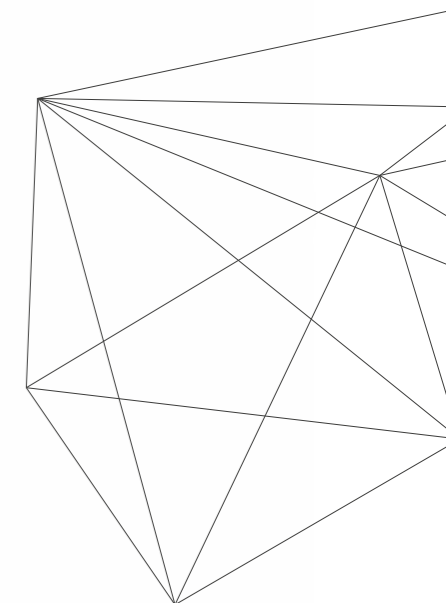



— OUR GROUP OF COMPANIES

—
The establishment of the foreign companies has allowed us to expand the presence of SISGEO abroad offering solutions focused to the needs of individual markets.
 —

SISGEO is the head of a Group of Companies that includes FIELD S.r.l., NEXT Industries S.r.l., and the subsidiaries SISGEO France, SISGEO Asia Pacific and SISGEO Latinoamerica.

FIELD, founded in 2000, specializes in providing integrated and customized solutions from design, installation and management of geotechnical and structural monitoring systems. Its services include on-site tests and a qualified service of real time data management thanks to the innovative WMS (Web Monitoring System) software.

The establishment of the foreign companies such as SISGEO Asia Pacific (Thailand), SISGEO Latinoamerica (Colombia) and SISGEO Australia (Australia), has allowed us to expand the presence of SISGEO abroad offering solutions focused to the needs of individual markets.

3 MD-PROFILE inclinometer



3

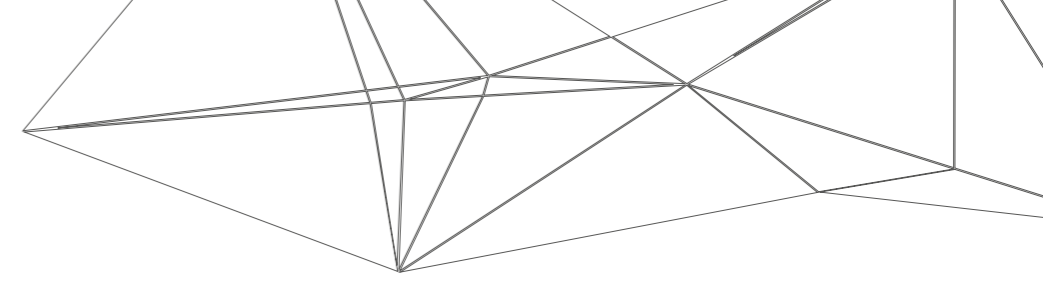

4

—
SISGEO considers manufacturing procedures, Client feedback and good organization to be the fundamental concepts to achieve quality.
 —

— 100% RELIABLE QUALITY

**COMPANY WITH
 QUALITY SYSTEM
 CERTIFIED BY DNV GL
 = ISO 9001 =**

SISGEO considers manufacturing procedures, Client feedback and good organization to be the fundamental concepts to achieve quality. In 1997 SISGEO obtained the ISO 9001 Certification and since then, the constant and continuous application of our Quality System, widespread at all levels of the company, is a source of improvement, evolution and growth.

4 B.R.A.IN system reel



TECHNOLOGICAL PASSION

SISGEO, thanks to innovative automated solutions, has optimized the efficiency of its manufacturing process. This, together with our passion, ensures the highest standard of products to the Client.



5

Research and development are hallmarks of SISGEO.

A continuous commitment is reflected both in the design of new and innovative products and in the optimization of equipment used in the manufacturing process, which results in our product line always being technologically up to date.

Following its steady growth in sales, SISGEO, thanks to innovative automated solutions, has optimized the efficiency of its manufacturing process. This, together with our passion, ensures the highest standard of products to the Client.

SISGEO's wide range of products employ various technologies including vibrating wire and other industrial sensors such as MEMS which we have tailored to suite many different applications.

5 H-LEVEL Liquid Level System

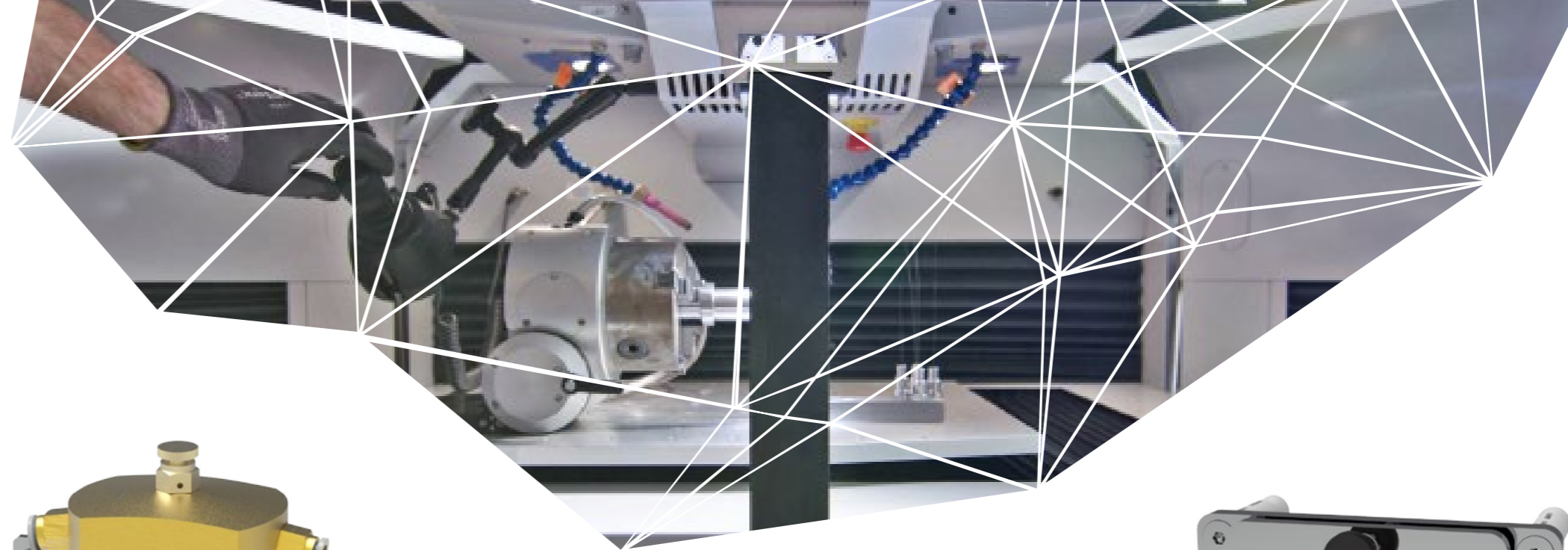

A team of SISGEO qualified and experienced engineers, technicians, hardware specialists and software programmers are constantly involved in production, calibration and research activities



6

PRODUCTION HEART

SISGEO utilizes, in its production department and laboratory, quality equipment including:

- assembly jigs for the production of vibrating wire sensors;
- automated calibration tables for inclinometers, displacement and pressure transducers;
- climate chambers for heat treatment including the ageing of vibrating wire sensors;
- TIG welding;
- semi automatic device for de-airing oil and filling under vacuum load/pressure cells;
- in line assembling of multipoint borehole extensometers up to 60m length;
- hydraulic press, up to 3000 KN capacity;
- pressure vessels for waterproofing tests;
- automatic tool for mixing epoxy used for sealing instruments.

The calibration tables are electronically controlled to automatically generate calibration reports. A team of SISGEO qualified and experienced engineers, technicians, hardware specialists and software programmers are constantly involved in production, calibration and research activities.

6 S5HD digital tilt meter with adjustable plate

GEOTECHNICAL INSTRUMENTS AND STRUCTURAL HEALTH MONITORING

— PIEZOMETERS

<i>Vibrating wire piezometers</i>	13
<i>Titanium piezometers</i>	13
<i>Piezo resistive piezometers</i>	13
<i>Drive-in piezometers</i>	15
<i>Removable pore pressure transducers</i>	15
<i>Multipoint piezometer string</i>	15
<i>Vented pressure transducers</i>	17
<i>Staff gauges</i>	17
<i>Seepage measurements weir monitoring</i>	17
<i>Water level indicators (WLI)</i>	19
<i>Standpipe and Casagrande piezometers</i>	19

— INCLINOMETERS

<i>Standard inclinometer casings</i>	21
<i>Easy-lock and quick-joint casings</i>	21
<i>Combined inclinometer and settlement measurement</i>	21
<i>B.R.A.IN inclinometer system</i>	23
<i>Mems inclinometer and spiral probe</i>	23
<i>KLION analysis software</i>	23
<i>MEMS in-place inclinometer</i>	25
<i>MD-Profile system</i>	25
<i>LT-Inclibus</i>	25
<i>BH-Profile in-place inclinometer</i>	27
<i>Horizontal in-place inclinometer</i>	27
<i>Surface tiltmeter</i>	29
<i>D-Tiltmeter</i>	29
<i>Tilt beam sensors</i>	29
<i>Tilli portable tiltmeter</i>	31
<i>Submersible MEMS tiltmeter</i>	31

— SETTLEMENT GAUGES

<i>H-Level liquid level system</i>	33
<i>Multipoint settlement system</i>	33
<i>Prisms and targets</i>	33
<i>T-Rex incremental extensometer</i>	35
<i>DEX in-place extensometer</i>	35
<i>DEX-S 3D in-place extenso-inclinometer</i>	35
<i>Fixed extensometer</i>	37
<i>Magnet extensometer (BRS)</i>	37

— PRESSURE & LOAD CELLS

<i>Earth pressure cells</i>	39
<i>Hydraulic pressure cells</i>	39
<i>Hydraulic anchor load cells</i>	41
<i>Electric anchor load cells</i>	41
<i>Electro-hydraulic load cells</i>	41

— EXTENSOMETERS & JOINTMETERS

<i>Embankment extensometers</i>	43
<i>Embedment jointmeters</i>	43
<i>Multipoint rod extensometer (MPBX)</i>	45
<i>Displacement transducers for MPBX</i>	45
<i>MEXID extensometer</i>	45
<i>Wire crackmeter and deformer</i>	47
<i>Electrical and vibrating wire crackmeters</i>	47
<i>3D Mechanical crackmeter</i>	47

— STRAIN-GAUGES & THERMOMETERS

<i>Vibrating wire strain-gauges</i>	49
<i>Spot weldable strain gauges</i>	49
<i>Embedment thermometers</i>	51
<i>Temperature strings</i>	51

— PENDULUMS & READOUT

<i>Direct and inverted pendulums</i>	53
<i>T-1000 Telependulum</i>	53
<i>Optical pendulum readout</i>	53

— READOUTS, DATALOGGERS & ACCESSORIES

<i>MIND readout</i>	55
<i>MIND App main features</i>	55
<i>MiniOMNIA datalogger</i>	55
<i>OMNIAlog datalogger</i>	57
<i>OMNIAlog cabinets</i>	57
<i>Remote multiplexers</i>	57
<i>WR LOG wireless monitoring system</i>	59
<i>Readout accessories and spare parts</i>	59
<i>Signal and multicore cables</i>	59

— SISGEO RAIL® MONITORING SOLUTIONS FOR RAILWAY INFRASTRUCTURES

<i>SISGEO RAIL®</i>	61
<i>FLX-RAIL® rail swing monitoring</i>	61
<i>RDS Railway Deformation System</i>	61



PIEZOMETERS

_GROUND WATER LEVEL

_PORE WATER PRESSURE

_EARTHFILL DAMS
AND EMBANKMENTS

_UP-LIFT PRESSURE
IN DAM FOUNDATIONS

_SEEPAGE MONITORING

_WATER PRESSURE BEHIND
TUNNEL LININGS

_POTENTIAL LANDSLIDES

_DEWATERING AND PUMP TESTS

_FOUNDATIONS
AND DIAPHRAGM WALLS

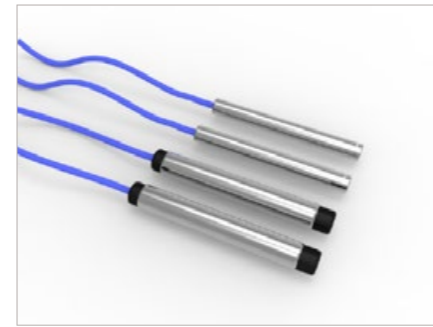

VIBRATING WIRE PIEZOMETERS

VW piezometers consist of a vibrating wire sensing element enclosed in a protective stainless steel housing a filter tip. VW piezometers offer an excellent long-term reliability as a result from the use of the latest developments in vibrating wire technology. Heavy duty model PK45 is recommended for use in earthfill dams with armoured cable.

STANDARD VW PIEZOMETERS

MODEL PK20A	with HAE value filter unit
MODEL PK20S	with LAE value filter unit
Standard ranges	0 - 170 kPa 0 - 5.0 MPa
Sensitivity	0.025% FS
Accuracy (MPE*)	< ±0.25% FS
Temp. operating range	-20°C +80°C
Filter unit features:	
- HAE	0.25 µ ceramic stone
- LAE (100kPa)	40 µ synthesized s/steel 50 µ synthesized PE
Diameter / length	20 mm / 177 mm

HEAVY DUTY PIEZOMETERS

MODEL PK45A	with HAE value filter unit
MODEL PK45S	with LAE value filter unit
Standard ranges	0 - 170 kPa 0 - 5.0 MPa
Sensitivity	0.025% FS
Accuracy (MPE*)	< ±0.25% FS
Temp. operating range	-20°C +80°C
Filter unit features:	
- HAE stone	1 µ ceramic stone
- LAE (100 kPa)	40 µ synthesized s/steel 50 µ synthesized PE (Vyon®)
Diameter / length	27 mm / 201 mm

(*) MPE is the Maximum Permitted Error on the measuring range (FSR). In the Calibration Report, the accuracies of the gauge are calculated using both linear regression (≤ Lin. MPE) and polynomial correction (≤ Pol. MPE).

SISGEO.COM



TITANIUM PIEZOMETERS

Titanium piezometers have been specifically designed for installation in high corrosive environments and aggressive soils. All the exposed surfaces are made of titanium and the ceramic membrane (diaphragm) is chemically inert. Titanium piezometers are recommended in landfills, brackish groundwaters and aggressive mine tailings.

TECHNICAL SPECIFICATIONS

MODEL P235TI	with HAE or LAE value filter
Standard ranges	200, 500 kPa, 1.0, 2.0 MPa
Signal output	4-20 mA current loop
Sensitivity	0.01% FS
Accuracy (MPE*)	< ±0.15% FS < ±0.20% FS (for 200 kPa FS)
Power supply	12 - 24 V DC
Temp. Operating range	-20°C +80°C
Filter unit characteristics:	
- HAE	0.25 µ ceramic stone
- LAE (100 kPa)	40 µ synthesized PE (Vyon®)
Diameter / length	27 mm / 193 mm

Sisgeo tests have verified that titanium piezometers do not have functionality or corrosion problems after one year in a solution with pH = 1 and temperature 20 °C.

OPF01SAT000 SATURATION DEVICE

The filter saturation is a decisive factor for a successful installation of embedded piezometers. Sisgeo provides a device for field use for the saturation of the HAE value filter (ceramic stone). It consists of a stainless steel pump with manometer and a threaded port to fit the filter unit.



PIEZO-RESISTIVE PIEZOMETERS

Piezo-resistive piezometers and pressure transducers combine mechanical robustness, capacity to withstand aggressive environments and performance reliability. Piezo-resistive piezometers are suitable for dynamic measurements of water level or pore water pressure, and when data acquisition system is not compatible with vibrating wire technology

TECHNICAL SPECIFICATIONS

MODEL P235S1	with HAE value filter
MODEL P235S4	with LAE value filter
Standard ranges	200, 500 kPa 1.0, 2.0, 5.0 MPa
Signal output	4-20 mA current loop
Sensitivity	0.01% FS
Accuracy (MPE*)	< ±0.15% FS < ±0.20% FS (for 100 and 200 kPa FS)
Temp. Operating range	-20°C +80°C
Filter unit characteristics:	
- HAE	0.25 µ ceramic stone
- LAE (100 kPa)	40 µ synthesized s/steel 50 µ synthesized PE
Diameter / length	27 mm / 193 mm

ACCESSORIES

OPXPUMP0020	Pneumatic hand pump for checking the pore pressure transducers calibration.
OPX20CHECK0	Tools for OPXPUMP0020 to allow PK20 connection

SPARE PARTS

OPF20D16000	HAE filter stone for PK20
OPF20D2000P	LAE Vyon® filter for PK20
OPF20D20000	LAE s/steel filter for PK20
OPF01D16000	HAE filter stone for PK45
OPF40D2000P	LAE Vyon® filter for PK45
OPF40D20000	LAE s/steel filter for PK45



Project:
Saint Helena Airport,
Saint Helena Island

PIEZOMETERS

- _ GROUND WATER LEVEL
- _ PORE WATER PRESSURE
- _ EARTHFILL DAMS AND EMBANKMENTS
- _ UP-LIFT PRESSURE IN DAM FOUNDATIONS
- _ SEEPAGE MONITORING
- _ WATER PRESSURE BEHIND TUNNEL LININGS
- _ POTENTIAL LANDSLIDES
- _ DEWATERING AND PUMP TESTS
- _ FOUNDATIONS AND DIAPHRAGM WALLS

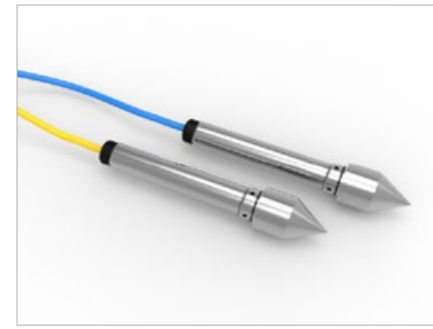

DRIVE-IN PIEZOMETERS

Drive-in piezometers have the transducer mounted inside a cylindrical body with a conical nose and housing for the push-in rod. The large diameter of the conical nose prevents any chance of overpressure during the installation into the soil (push-in). The push-in rod allows installation using conventional cone penetrometer or drilling rod with adapters.

AVAILABLE MODELS		CE
MODEL PK45I	VIBRATING WIRE	
Standard ranges	0 - 350 kPa, 0 - 2.0 MPa	
Sensitivity	0.025% FS	
Accuracy (MPE*)	< ±0.25% FS	
Temp. operating range	-20°C +80°C	
MODEL P235I	PIEZORESISTIVE	
Standard ranges	0 - 200 kPa, 0 - 5.0 MPa	
Signal output	4-20 mA current loop	
Sensitivity	0.01% FS	
Accuracy (MPE*)	< ±0.15% FS	
	< ±0.20% FS (for 200 kPa FS)	
Temp. operating range	-10°C +55°C	
Filter unit	Ceramic HAE filter. Filter on request should be saturated at factory.	
Diameter / length	27 mm / 256 mm	
Nose diameter	30 mm	

ACCESSORIES

SPUSH - IN ROD OP235I ROD00	Stainless steel 430 mm long tube which allows the junction with standard CPT rods. The push-in rod shall be threaded at job site and it must be reused. Length: 430 mm OD/ID: 33.7 / 29.1 mm
SATURATION DEVICE OPF01SAT000	Stainless steel pump for saturating HAE ceramic filters. Includes pump, 10 bar pressure gauge, and a threaded connection for the filters.

(*) MPE is the Maximum Permitted Error on the measuring range (FSR). In the Calibration Report, the accuracies of the gauge are calculated using both linear regression (\leq Lin. MPE) and polynomial correction (\leq Pol. MPE).

SISGEO.COM

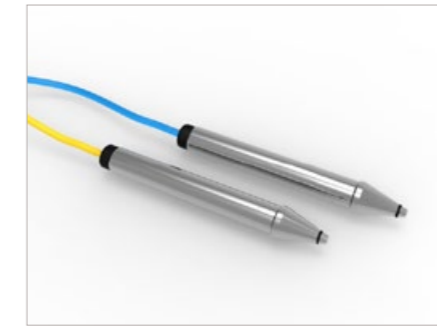

REMOVABLE PRESSURE TRANSDUCERS

The removable pressure transducers are installed in Casagrande piezometers with the P101 porous filter unit which mates to the conical tip of the transducer housing. The removable pressure transducers are specially designed for long-term monitoring of soil pore pressure. They can be removed for calibration checks, maintenance or re-used in other boreholes.

AVAILABLE MODELS		CE
MODEL PK45C2	VW range 0-200 kPa	
MODEL PK45C5	VW range 0-500 kPa	
Signal output	frequency (VW), resistance (T)	
Sensitivity	0.025% FS	
Accuracy (MPE*)	< ±0.25% FS	
Temp. operating range	-20°C +80°C	
Diameter / length	27 mm body - 30 mm head / 230 mm	
MODEL P252C00200	PIEZORESISTIVE range 0-200 kPa	
MODEL P252C00500	PIEZORESISTIVE range 0-500 kPa	
Signal output	4-20 mA current loop	
Sensitivity	0.01% FS	
Total accuracy	< ±0.20% FS for P252C00200 < ±0.15% FS for P252C00500	
Temp. operating range	-10°C +55°C	
Diameter / length	27-30 mm / 230 mm	
OP101002000	CASAGRANDE POROUS TIP	

INSTALLATION DETAIL

The transducer tip, fitted with an 'O' ring, is designed to mate to the conical port of P101 Casagrande filter unit. Sealing is maintained by ballasting weights inserted on the electric cable. A small hole on the conical tip allows pore pressure to act on the diaphragm sensor. P101 porous filter is installed as usual and the transducer is then lowered into the access tube, suspended by its own electro-mechanical cable until the piezometer assembly rest on the piezometer. The transducer can be removed from the borehole by means of the electro-mechanical cable.

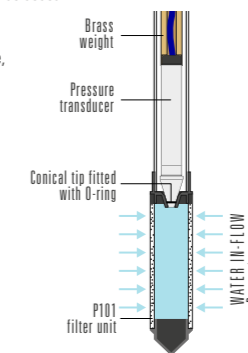

MULTIPOINT PIEZOMETER STRING

Multi-point piezometer consists of a string of vibrating wire piezometers connected by single multicore cable, ideal when more than one piezometer is requested at various depth in the same borehole. The PK45M piezometer string - fully grouted in borehole - prevents the formation of channels for migration of water between different soil levels.

TECHNICAL SPECIFICATIONS		CE
Standard ranges	0 - 350 up to 3.5 MPa	
Signal output	frequency (VW), resistance (T)	
Sensitivity	0.025% FS	
Accuracy (MPE*)	< ±0.25% FS	
Temp. operating range	-20°C +80°C	
Filter unit	40 μ synthesized s/steel	
Diameter / length	48.3 mm / 252 mm	

SIGNAL CABLES

OWE1160LSZH	LSZH or PVC multicore cable (8 pairs). It permits the realization of a string of 4 VW piezometers.
OWE1160PVC	
OWE1320LSZH	LSZH or PVC multicore cable (16 pairs). It permits the realization of a string of 8 VW piezometers.
OWE1320PVC	

FULLY GROUTED INSTALLATION METHOD

The fully-grouted method is gaining popularity because it is a simple, economical and accurate procedure to monitor pore water pressure in the field. The working principle is based on the idea that a diaphragm piezometer embedded directly in a large mass of low permeability cement-bentonite grout should respond instantly to a pore water pressure change. Grout mixes (water-cement-bentonite) are controlled to give the desired strength of the set grout. Appropriate permeability of the cement-bentonite grout is crucial for the success of the fully-grouted method.

For more details, refer to: "Piezometers in Fully Grouted Boreholes" by Mikkelsen and Green, FMGM proceedings Oslo 2003.

Project:
Roodbar Lorestan Dam
I.R of Iran

PIEZOMETERS

- _ GROUND WATER LEVEL
- _ PORE WATER PRESSURE
- _ EARTHFILL DAMS AND EMBANKMENTS
- _ UP-LIFT PRESSURE IN DAM FOUNDATIONS
- _ SEEPAGE MONITORING
- _ WATER PRESSURE BEHIND TUNNEL LININGS
- _ POTENTIAL LANDSLIDES
- _ DEWATERING AND PUMP TESTS
- _ FOUNDATIONS AND DIAPHRAGM WALLS



VENTED PRESSURE TRANSDUCERS

The model P252R is a level transducer equipped with a relative vented piezoresistive pressure sensor which provides automatic compensation of the barometric changes. This transducer provides ground water table monitoring in standpipe and Casagrande piezometers.

TECHNICAL SPECIFICATIONS

Standard ranges	100, 200, 500 kPa, 1.0 MPa
Signal output	4-20 mA current loop
Sensitivity	0.01% FS
Accuracy (MPE*)	< ±0.25% FS
Power supply	12 - 24 V DC
Overpressure	1.3 x FS
Thermal zero shift	0.00025% FS / °C
Temp. Operating range	-10°C +55°C
Filter unit	synthesized stainless steel or Vyon®
Body material	stainless steel
Diameter / length	27 mm / 191,5 mm
Cable	OWE203KEOZH

ACCESSORIES

SUPPORT HEAD OP200CH1000	Lockable support head assembly with data plate. Positioned on the top of the standpipe permits to suspend the transducer by a secure cable stop.
VENTED BOX OEPDP002W00	Vented IP67 plastic box equipped with overvoltage protections and cable glands.

(*) MPE is the Maximum Permitted Error on the measuring range (FSR). In the Calibration Report, the accuracies of the gauge are calculated using both linear regression (≤ Lin. MPE) and polynomial correction (≤ Pol. MPE).



STAFF GAUGES

The staff gauges are used for a quick visual indication of the surface level in reservoirs, rivers, streams and open channels. These environmentally rugged iron gauges are finished with porcelain enamel to ensure easy reading and resist to rust or discoloration. Each gauge is accurately graduated and has holes for easy fastening to walls, piers and other structures.

STANDARD COMPONENTS

STAFF GAUGE OHIDR1000S0	Hydrometric rod 1 meter long, black and white colors. It is divided into centimeters with each decimeter numbered. Rods for any elevation may be assembled. Separate number plates are available to show elevation. Available also in different colors on request.
FIGURE PLATE OHIDR1310P0	Number plate with three (3) figures which represent elevation. The three figures are on white porcelain enameled plate. Using a combination of these figures any elevation may be represented. Available also in different colors on request.

SPECIAL PARTS

INCLINED STAFF GAUGES	They are customized gauges for installation on inclined surface such as upstream face of dams or concrete lined irrigation channels. Mounted flush on the sloped sides, these staff gauges give a direct reading of the vertical stage height.
-----------------------	--

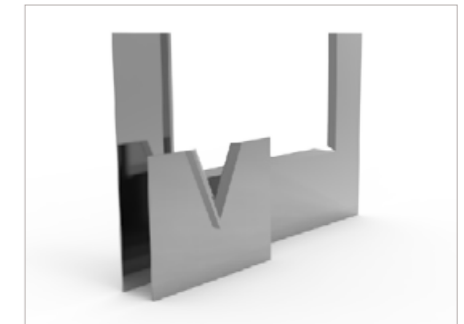

SEEPAGE MEASUREMENTS WEIR MONITORING

V-notch weirs are typically installed in open channels such as streams to determine discharge (flowrate). The basic principle is that the discharge is directly related to the water depth above the bottom of the "V". Leakage measurement is one of the most important indicators of the overall performance of dikes and dams.

V-NOTCH WEIRS

The purpose of the weir is to transform the instantaneous flow values into the pressure/level by means of specific measuring equipment. V-notch weirs are preferred for low discharges as the head above the weir crest is more sensitive to changes in flow compared to rectangular weirs.

0QV45LS1000	10 litre/sec, V-angle 45°
0QV60LS2000	20 litre/sec, V-angle 60°
0QV90LS5000	50 litre/sec, rectangular

WATER LEVEL TRANSDUCER

The V-notch water level transducer consists of a highly sensitive relative pressure sensor with 2 m vented cable and junction box with 3 levels of overvoltage protection.

0QVML0500EX	Level transducer, range 0-500mm
0QVML1000EX	Level transducer, range 0-1000mm
Transducer type	relative pressure transducer
Measuring range	500 or 1000 mm H ₂ O
Accuracy	±0.1 mm H ₂ O
Output signal	4-20 mA current loop
Power supply	12 - 24 V DC
Operating temperature	-10°C to +80°C

ACCESSORIES AND SPARE PARTS

0QVHI030000	Staff gauge for V-notch 300 mm long, millimetre division
0QVHI050000	Staff gauge for V-notch 500 mm long, millimetre division
0P252Q000000	Spare pressure transducer 500 or 1000 mm H ₂ O
0EPDP002W00	Spare junction box with OVP



Project:
Nam Gnuang Dam
Laos

PIEZOMETERS



- _ GROUND WATER LEVEL
- _ PORE WATER PRESSURE
- _ EARTHFILL DAMS AND EMBANKMENTS
- _ UP-LIFT PRESSURE IN DAM FOUNDATIONS
- _ SEEPAGE MONITORING
- _ WATER PRESSURE BEHIND TUNNEL LININGS
- _ POTENTIAL LANDSLIDES
- _ DEWATERING AND PUMP TESTS
- _ FOUNDATIONS AND DIAPHRAGM WALLS

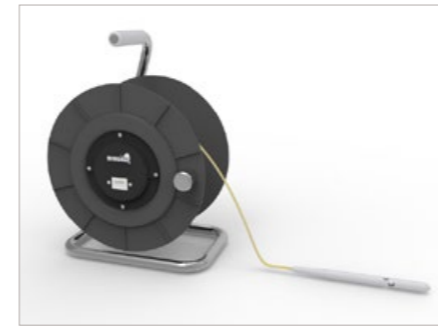

WATER LEVEL INDICATORS (WLI)

The WLI or Dipmeters are used to measure the water level in standpipes piezometers. WLI is a battery powered portable device equipped with a stainless steel sensor probe connected to a graduated flat cable rolled up on a hand reel containing audio and visual indicators, and battery. The model C112T includes a digital indicator for temperature readings.

AVAILABLE MODELS

MODEL C112	flat cable with marks at every millimetre
Probe	water level detector
Cable lengths	30, 50, 100 m 150, 200, 300, 400, 500 m
Probe diameter	16 mm
Battery	1 x 9V DC disposable
MODEL C112T	flat cable with marks at every millimetre
Probe	water level detector and temperature sensor
Cable lengths	30, 50, 100 m 150, 200, 300, 400, 500 m
Reel diameter	260 mm, 320 mm, 420 mm
Probe diameter	16 mm
Display	3.5 LCD (only for C112T)
Battery	2 x 9V DC disposable

PROBE SPARE PARTS



OC112KITR00	Probe spare set for the model C112 including sensor probe weights and epoxy.
OC112TKITR0	Probe spare set for the model C112T including sensor probe weights and epoxy.



STANDPIPE AND CASAGRANDE PIEZOMETERS

Standpipe and Casagrande piezometers are open piezometers widely used to monitor piezometric water levels in vertical boreholes. Open piezometer consists of two parts: a porous tip and a riser pipe which continues upwards out of the top of the borehole. The porous tips are located within a sand filter zone and a bentonite seal is required between the sand filter zone and the backfill.

AVAILABLE MODELS

P101		Casagrande/standpipe 40 µ porous tip 1-half inch single tube connection Length: 200 mm Outer diameter: 61.5 mm
P112		Casagrande 40 µ porous tip half inch twin tubes connection Length: 200 mm Outer diameter: 61.5 mm
TFH		Standpipe filter unit PVC slotted tube with fabric Available diameters: 1, 1 1/2 and 2-inch Length: 3 meter

ACCESSORIES

LOCKABLE CAP OP100CH1000	Equipped with an identification plate and a topographic pin, the lockable cap ensures protection at the top end of Casagrande and standpipe piezometers.
BENTONITE PELLETS 1000BE20025K	Supplied in 25 Kg bags, the pellets work as a watertight sealant inside the borehole of the piezometer filter unit.

EXAMPLE OF CASAGRANDE PIEZOMETERS

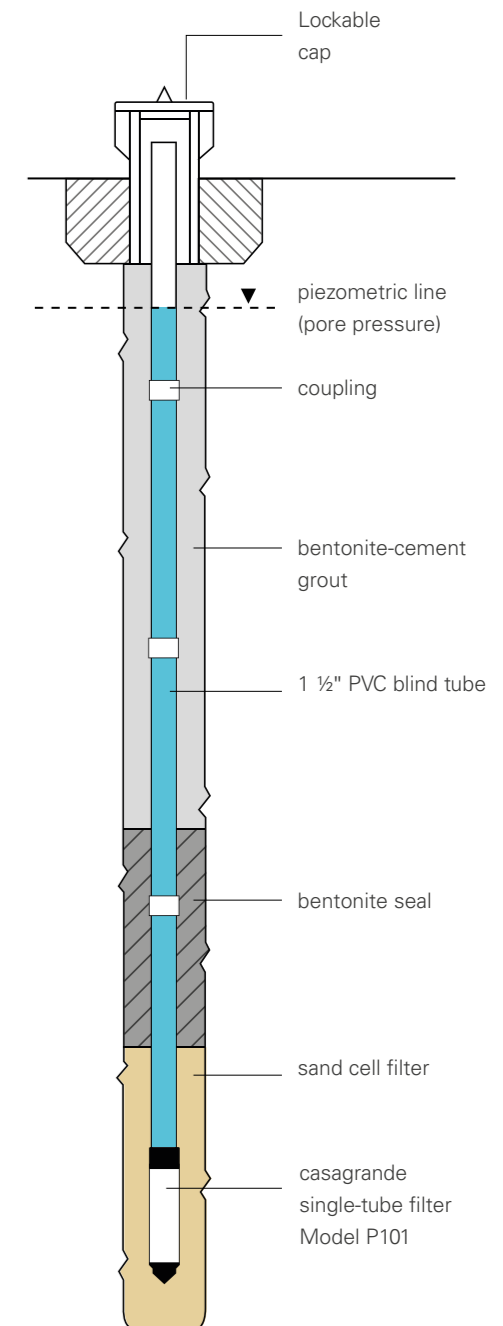

Project:
Forrestfield Airport Link
Australia

- _LANDSLIDES
- _DAMS
- _UNSTABLE SLOPES
- _PILES
- _DIAPHRAGM WALLS
- _TUNNELING
- _DEEP EXCAVATIONS
- _BRIDGES AND VIADUCTS
- _EMBANKMENTS

Project:
Salman Farsi
Iran



STANDARD INCLINOMETER CASINGS

Aluminium or ABS inclinometer casings are special grooved tubes, generally installed into a borehole, and used in conjunction with an inclinometer system to determine sub-surface ground or horizontal soil movements. Standard inclinometer casings assembly require drill, rivets, glue and tape.

ALUMINIUM INCLINOMETERS

Models	S1110075	S1110054
Material	Aluminium	Aluminium
Outer diameter	86.4 mm	58.0 mm
Inner diameter	76.1 mm	49.0 mm
Groove inner diameter	82.0 mm	54.0 mm
Casing length	3 meter	3 meter
Weight	1.4 kg/m	0.92 kg/m
Spiral	<1.0° / 3 m	<1.0° / 3 m
Coupling O.D.	92.0 mm	62.6 mm

STANDARD ABS INCLINOMETERS

Model	S13100603M	S13100610F
Material	ABS plastic	ABS plastic
Tube outer diameter	71.0 mm	71.0 mm
Tube inner diameter	60.0 mm	60.0 mm
Tube groove inner diameter	64.0 mm	64.0 mm
Casing length	3 m	10 ft
Weight	0.7 kg/m	0.21 kg/ft
Spiral	<0.6° / 3 m	<0.6° / 10 ft
Coupling outer diameter	77.0 mm	77.0 mm
Coupling length	200 mm	200 mm



EASY LOCK AND QUICK-JOINT ABS CASINGS

The Easy Lock inclinometer casing is a grooved tube machined at the end to have a self-aligning and fast junction. The QJ Quick-Joint casing consists of sections with built-in couplings that snap together. Both models are produced from high-quality virgin ABS and have O-rings ensure that the joint is grout proof.

OS143107000 EASY LOCK INCLIN. CASING

Material	ABS plastic
Outer diameter	70 mm
Inner diameter	58 mm
Groove inner diam.	63.5 mm
Overall casing length	3055 mm (casing + coupling)
Overall casing weight	3.6 kg (casing + coupling)
Spiral (1)	< 0.2° / m
Collapse test (2)	15 bar
HDT test ISO 75	+83°C

OS151107000 QJ INCLINOMETER CASING

Material	ABS plastic
Tube outer diameter	70 mm
Tube inner diameter	59 mm
Overall section length	3100 mm
Overall diameter	84 mm
Colour	white / red
Spiral (1)	<0.6° / 3 m
Collapse test (2)	15 bar
Temperature range	-20°C +80°C

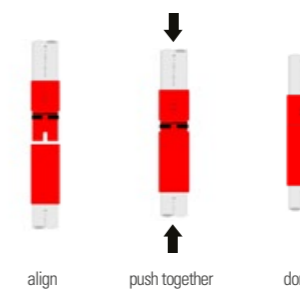

(1) During manufacturing a particular attention is paid to minimise the spiral of the casing grooves and to machine the aligning key for casing junction with self-aligning couplings.

(2) Test was performed in a water pressure chamber with empty casing sealed at the two ends.



COMBINED INCLINOMETER AND SETTLEMENT MEASUREMENT

Inclinometer and settlement measurements may be combined in the same borehole or in an embankment. The system consists of an ABS inclinometer casing equipped with telescopic couplings and settlement rings with permanent magnets. Settlement rings are available with spring spiders for installation in borehole or with round plates for embankments.

ACCESSORIES FOR EASY LOCK CASING

OS143ST0000	TELESCOPIC SECTION 3 meter section with 70 or 150 mm gap
OS131AF6000	SPIDER MAGNET RING Used in borehole with spring legs
OS131AR6000	EMBANKMENT MAGNET RING Used in fill with plate, OD 300 mm

ACCESSORIES FOR QJ CASING

OS151MT0700	QJ TELESCOPIC COUPLING 500 mm long with 75 mm gap
OS151DR7000	QJ DATUM REFERENCE SECTION Bottom section with datum magnet
OS151AF8000	SPIDER MAGNET RING, ID 83 MM Used in borehole with spring legs
OS151AR8000	EMBANKMENT MAGNET RING Used in fill with plate, OD 300 mm

MEASUREMENTS

Manual readings are carried out lowering inside the casing:

- the inclinometer probe for monitoring the horizontal movements;
- the portable magnet extensometer readout model C121 with millimetre tape for detecting settlements.

INCLINOMETERS

- _LANDSLIDES
- _DAMS
- _UNSTABLE SLOPES
- _PILES
- _DIAPHRAGM WALLS
- _TUNNELING
- _DEEP EXCAVATIONS
- _BRIDGES AND VIADUCTS
- _EMBANKMENTS



Project:
Sogamoso HPP
Colombia



B.R.A.IN INCLINOMETER SYSTEM

B.R.A.IN (Borehole Readout Array for INclinometers) system is mainly composed by digital inclinometer probe, bluetooth reel with control cable and B.R.A.IN APP compatible with Android and iOS devices. The intuitive B.R.A.IN APP allows the user to manage the inclinometer and spiral meter surveys and immediately share the readings with the most popular APP installed on the device.

VERTICAL SYSTEMS PERFORMANCES

Readout value	20000 sin alpha (other values available on request)
System resolution:	
- with 500 mm gauge length	0.011 mm / 500 mm
- with 1000 mm	0.023 mm / 1000 mm
- with 2 ft gauge length	±0.0005 in/2 ft
Repeatability (precision) ¹	
- with 500 mm gauge length	± 1.5 mm / 30 m
- with 1000 mm	± 2.0 mm / 30 m
- with 2 ft gauge length	±0.079 in/100 ft

HORIZONTAL SYSTEMS PERFORMANCES

Readout value	20000 sin alpha (other values available on request)
System resolution:	
with 500 mm gauge length	0.011 mm / 500 mm
with 1000 mm gauge length	0.023 mm / 1000 mm
Repeatability (precision) ¹	
with 500 mm gauge length	± 7.0 mm / 30 m
with 1000 mm gauge length	± 10.0 mm / 30 m

(1) As for ISO 18674-3, this is the "difference between the cumulated displacements of a measuring point relative to a reference point 30 m apart, when repeatedly carrying out the survey under repeatability conditions."

B.R.A.IN APP

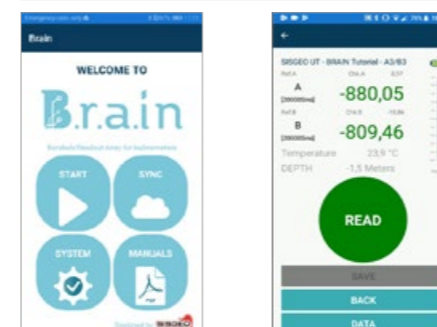

Two example of screenshot

SISGEO.COM



MEMS INCLINOMETER AND SPIRAL PROBES

The vertical and horizontal inclinometer probe is composed by a high performance MEMS sensors and a digitalizing electronic board, mounded inside a stainless steel body with 4 spring-loaded wheels and a waterproof connector. The digital spiral meter is used to define the azimuth of the installed inclinometer casing in order to verify that the casing has been installed correctly.

OS242DV3000 VERTICAL PROBE

Measuring range	±30°
Sensor type	biaxial digital MEMS
Probe accuracy (MPE*)	±0.01% FS
Temp. operating range	-30°C to +70°C
Body material and diam.	stainless steel, 28 mm
Gauge length	500mm, 1000mm, 2 ft
Wheels	2 spring-loaded carriages with 2 wheels each
IP rate	IP68 up to 2.0 MPa

OS241DH3000 HORIZONTAL PROBE

Measuring range	±30°
Sensor type	uniaxial digital MEMS
Probe accuracy (MPE*)	±0.01% FS
Temp. operating range	-30°C to +70°C
Body material and diam.	stainless steel, 28 mm
Gauge length	500mm, 1000mm
Wheels	2 fixed wheels and 2 spring-loaded wheels
IP rate	IP68 up to 2.0 MPa

OS30PR12D00 DIGITAL SPIRAL PROBE

Measuring range	±5° over wheels base (1000 mm)
Sensor type	rotary contactless potentiometer (magneto-resistive)
Resolution	0.001 FS
Repeatability	±0.01% FS
Stability	± 0.025% FS
Accuracy	< ±0.5% FS
Power supply	± 2.5 V DC
Diameter	28 mm
Length	1250 mm (without connector)
Wheel base	1000 mm
Connector	watertight, 6 pins

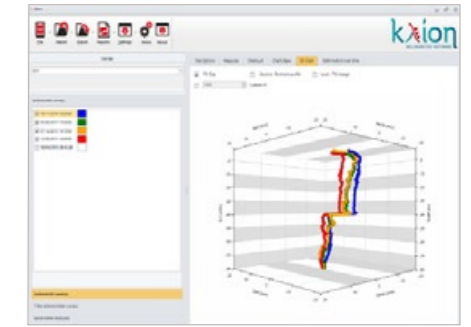

KLION ANALYSIS SOFTWARE

KLION is a specially designed software to process inclinometer, spiral meter and T-Rex extensometer data from vertical and horizontal boreholes, providing graphs and reports. Data files may be created by manual data entry or directly from Archimede or B.R.A.IN readouts. Advanced data analysis using Mikkelsen suggestions (FMGM 2003) are available.

SOFTWARE MAIN FEATURES

-  User - oriented interface for managing most operations with "point and click"
-  Set-up and manage both vertical and horizontal readings
-  Automatic compensation of the inclinometer data with spiral meter survey
-  Customizable report file with advanced Word Processor
-  Charts zoom-in or zoom-out with a simple mouse scroll
-  For inclinometers, customisable charts of deformation over time are available
-  With KLION you can view the inclinometer data elaborations in a 3D graph
-  Geolocation with Google Map tool and main displacement vectors
-  On-line automatic software updates if connected to the internet
-  Multilanguage software now available in English and Italian. More languages in the next revision.

OPERATIVE SYSTEM REQUIREMENTS

KLION works on Microsoft © Vista, 7, 8, 8.1 and 10 (32 and 64 bit)
HW minimum requirement: RAM 512 MB, HD 100 MB

INCLINOMETERS

- _LANDSLIDES
- _DAMS
- _UNSTABLE SLOPES
- _PILES
- _DIAPHRAGM WALLS
- _TUNNELING
- _DEEP EXCAVATIONS
- _BRIDGES AND VIADUCTS
- _EMBANKMENTS

Project:
Lyon-Turin high speed railway tunnel
Border France-Italy



MEMS IN-PLACE INCLINOMETER

In-Place Inclinerometers (IPI sensors) are designed for the automatic monitoring of critical locations. Jointed together by lengths of steel wire and suspended inside a vertical casing where deformation may occur, IPI sensors will follow the local inclination of the casing due to the horizontal soil movements.

AVAILABLE MODELS

MODEL S411HA	uniaxial
MODEL S412HA	biaxial
Sensor type	self compensated MEMS
Available ranges	$\pm 10^\circ$, $\pm 15^\circ$, $\pm 20^\circ$, $\pm 30^\circ$
Sensor resolution @ 2 Hz	0.00056° (0.01 mm/m)
Accuracy (MPE*)	$< \pm 0.05\%$ FS
Temperature dependency	$< \pm 0.005\%$ FS /°C
Signal output	4-20 mA current loop
Power supply	18 - 30 V DC
Temp. operating range	-30°C to +70°C
Temperature sensor	Built-in thermistor
Protection	IP68 up to 1.0 MPa

PROBE FEATURES

Outer diameter	28 mm
Wheel base	1000 mm
Total length	1230 mm
Material	s/steel and thermoplastic resin
Protection	IP68 up to 1.0 MPa

ACCESSORIES

OS4TS101000	In-place inclinometer support head
OS4IPIT00L0	In-place inclinom. clamping tool
OWRAC200000	Stainless steel support wire, 2 mm
OWE1061POZH	6 wires IPI cable, LSZH

(*) MPE is the Maximum Permitted Error on the measuring range (FSR). In the Calibration Report, the accuracies of the gauge are calculated using both linear regression (\leq Lin. MPE) and polynomial correction (\leq Pol. MPE).

SISGEO.COM



MD-PROFILE SYSTEM

MD-Profile gauges are designed to be placed within internally flush pipes. The system is suitable for geotechnical and structural applications, where vertical or horizontal accurate profiling is required. Each segment is mechanically and electrically linked to one another through connectors in a RS485 Modbus daisy chain configuration.

AVAILABLE MODELS

MODEL MDP30V	vertical biaxial
MODEL MDP30H	horizontal uniaxial
Sensor type	triaxial MEMS, 2-axis used
Available ranges	$\pm 30^\circ$ (other under request)
Sensor resolution	0.0002°
Accuracy (MPE*)	$< \pm 0.04\%$ FS with $\pm 30^\circ$ FS
Sensor temp. dependency	$< \pm 0.01\%$ °C (A axis - vertical) $< \pm 0.004\%$ °C (B axis - vertical) $< \pm 0.004\%$ °C (A axis - horizontal)
Power supply	8 - 28 V DC
Signal output	RS485, MODBUS RTU protocol
Temp. operating range	-30°C to +70°C

PROBE FEATURES

Probe diameter	28 mm
Probe material	s/steel and carbon fibre
Protection	IP68 up to 1.5 MPa
Available length	0.5m, 1.0m, 1.5m, 2.0m

ACCESSORIES

OMDHANGKIT0	MD Profile hanging kit
OS4TS101000	Support head
OMDP4ASC150	1.5" centering device
OMDP4ASC200	2.0" centering device
OETERMRESMD	MDP ending resistance
OMDP15TPV30	MDP 1.5" flush tube
OMDP20TPV30	MDP 2.0" flush tube
OEDSCKIT000	DSC SW config. kit



LT-INCLIBUS

The LT-Inclibus gauge is able to monitor local tilting along a line, assuring the alignment, distance and measuring axis orientation between the gauges. The standard segment is composed by a 2m fibre glass rod with two biaxial waterproof gauges, 1m spaced. The rods are connected through mechanical joints, while the gauges are connected in a RS485 chain.

AVAILABLE MODELS

MODEL LTIBV	vertical biaxial
MODEL LTIBH	horizontal biaxial
Sensor type	triaxial MEMS, 2-axis used
Available ranges	standard $\pm 10^\circ$ (other under request)
Sensor resolution	0.0002°
Accuracy (MPE*)	$< \pm 0.10\%$ FS with $\pm 10^\circ$ FS
Sensor temp. dependency	$< \pm 0.01\%$ °C (A axis - vertical) $< \pm 0.004\%$ °C (B axis - vertical) $< \pm 0.004\%$ °C (A and B axis - horiz.)
Power supply	8 - 28 V DC
Signal output	RS485, MODBUS RTU protocol
Temp. operating range	-30°C to +70°C

GAUGE FEATURES

Gauge section dimensions	145mm x 35mm x 35mm
Material	polycarbonate, FG rod
Protection	IP68 up to 1.0 MPa
whole length	2.0m

ACCESSORIES

OS400HD00MT	Cable with connector
OETERMRESIO	Eding resistance
OLTI BROD020	2m fibre-glass elongation rod (no sensors)

INCLINOMETERS 25



- _LANDSLIDES
- _DAMS
- _UNSTABLE SLOPES
- _PILES
- _DIAPHRAGM WALLS
- _TUNNELING
- _DEEP EXCAVATIONS
- _BRIDGES AND VIADUCTS
- _EMBANKMENTS

Project:
Metro Line C
Colosseum monitoring
Rome, Italy



BH-PROFILE IN-PLACE INCLINOMETER

Digital borehole profile in-place inclinometers offer the continuous remote monitoring of casings deformed by active soil movements. BH profile chain consists of a number of digital IPIs with carbon fiber extension rods and a terminal wheel assembly to close the chain. A single digital cable connects the system to OMNIalog for remote data management, real time monitoring and alarms.

AVAILABLE MODELS CE

MODEL S431HD	vertical uniaxial
MODEL S432HD	vertical biaxial
Sensor type	self compensated MEMS
Available ranges	$\pm 10^\circ, \pm 15^\circ, \pm 20^\circ, \pm 30^\circ$
Sensor resolution @ 2 Hz	0.00056° (0.01 mm/m)
Accuracy	
Pol. MPE ^(*)	$\pm 0.010\%$ FS with $\pm 10^\circ, \pm 15^\circ$ FS $\pm 0.015\%$ FS with $\pm 20^\circ, \pm 30^\circ$ FS
Offset temperature dependency	$\pm 0.002^\circ / ^\circ\text{C}$
Power supply	from 8 to 28 Vdc
Signal output	RS-485 with Modbus RTU protocol
Temp. operating range	-30°C to +70°C
IP class	IP68 up to 1.0 MPa

PROBE FEATURES

Sensed probe diameter	30 mm
Sensed probe material	s/steel and thermoplastic resin
Protection	IP68 up to 1 MPa
Extension rod	Carbon fiber, 20 mm OD

ACCESSORIES

OS430EX10RD	1 m carbon-fibre elongation rod
OS430EX20RD	2 m carbon-fibre elongation rod
OS43WHE2SSO	Terminal wheels assembly
OS4TS101000	Vertical IPI support head
OWRAC250000	s/steel support wire, 2.5 mm



HORIZONTAL IN-PLACE INCLINOMETER

IPI horizontal string is composed by a chain of IPI gauges with carbon fiber extension rods and a terminal wheels assembly. A string of horizontal IPIs is usually installed inside inclinometer casing buried within trenches, foundations or horizontal drill holes for automatic monitoring of settlements or heaves.

AVAILABLE MODELS CE

MODEL S441HD	horizontal uniaxial
Sensor type	self compensated MEMS
Available ranges	$\pm 10^\circ, \pm 15^\circ, \pm 20^\circ, \pm 30^\circ$
Sensor resolution @ 2 Hz	0.00056° (0.01 mm/m)
Accuracy	
Pol. MPE ^(*)	$\pm 0.010\%$ FS with $\pm 10^\circ, \pm 15^\circ$ FS $\pm 0.015\%$ FS with $\pm 20^\circ, \pm 30^\circ$ FS
Offset temperature dependency	$\pm 0.002^\circ / ^\circ\text{C}$
Power supply	from 8 to 28 Vdc
Signal output	RS-485 with Modbus RTU protocol
Temp. operating range	-30°C to +70°C
IP class	IP68 up to 1.0 MPa

PROBE FEATURES

Sensed probe diameter	30 mm
Sensed probe material	s/steel and thermoplastic resin
Protection	IP68 up to 1 MPa
Extension rod	Carbon fiber, 20 mm OD

ACCESSORIES

OS430EX10RD	1 m carbon-fibre elongation rod
OS430EX20RD	2 m carbon-fibre elongation rod
OS44WHE2SSO	Horizontal terminal wheels assembly
ODEXOTS2350	Horizontal IPI protective cap

(*) MPE is the Maximum Permitted Error on the measuring range (FSR). In the Calibration Report, the accuracies of the gauge are calculated using both linear regression (\leq Lin. MPE) and polynomial correction (\leq Pol. MPE).

EXAMPLE OF BH-PROFILE CHAIN

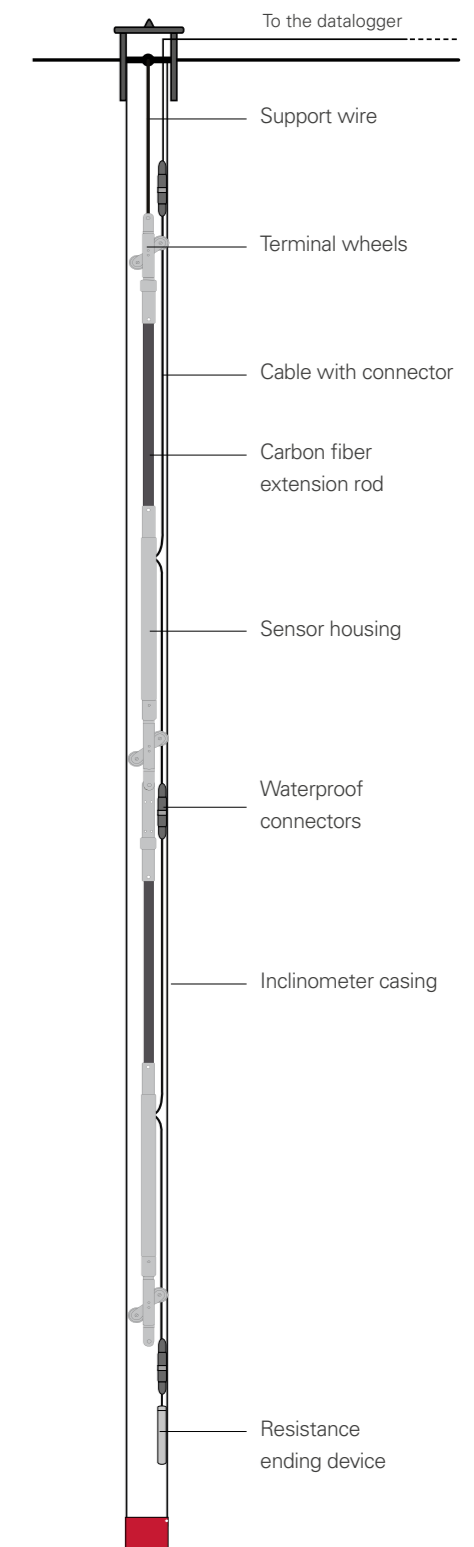

TILTMETERS

- _LANDSLIDES
- _DAMS
- _UNSTABLE SLOPES
- _PILES
- _DIAPHRAGM WALLS
- _TUNNELING
- _DEEP EXCAVATIONS
- _BRIDGES AND VIADUCTS
- _EMBANKMENTS

Project:
Cross strait tube project
Turkey



SURFACE TILTMETER

MEMS tiltmeters monitor tilt changes in either one or two axial planes perpendicular to the surface of the base plate. MEMS tiltmeters that are permanently installed on the structure, provide a long term monitoring and are designed to be read manually or by an automatic remote data logging system.

AVAILABLE MODELS

MODEL S541MA	uniaxial
MODEL S542MA	biaxial
Sensor type	self compensated MEMS
Available ranges	$\pm 2.5^\circ$, $\pm 5^\circ$, $\pm 10^\circ$
Sensor resolution	0.01% FS
Accuracy: Lin. MPE ^(*)	$\pm 0.008^\circ$ for $\pm 2.5^\circ$ range, $\pm 0.012^\circ$ for $\pm 5^\circ$ range, $\pm 0.020^\circ$ FS for $\pm 10^\circ$ range
Signal output	4-20 mA current loop (inclination), Ohm (temperature)
Power supply	18 - 30 V DC
Offset temperature dependency	$\pm 0.003^\circ / ^\circ\text{C}$ (from -20°C to $+70^\circ\text{C}$)
Temp. operating range	-30°C to $+70^\circ\text{C}$
Overall dimensions (LxHxW)	99 x 115 x 49 mm (including connectors)
Material and IP class	anodized aluminum, IP67

ACCESSORIES

OS540AP3D02	Fine adjustment base plate especially recommended for small ranges ($\pm 2.5^\circ$ and $\pm 5^\circ$)
OEPM010IP10	Junction box for digital sensor chains Measuring box for digital sensors chain.



D-TILTMETER

The D-Tiltmeters use digital MEMS tilt sensors. They are designed to be permanently installed to provide long term measurements. The D-Tiltmeters monitor tilt changes in either one or two axial planes perpendicular to the surface of the base plate. Waterproof connectors offer simple and easy connection in series.

AVAILABLE MODELS

MODEL S541HD	uniaxial
MODEL S542HD	biaxial
Sensor type	self compensated MEMS
Available ranges	$\pm 2.5^\circ$, $\pm 5^\circ$, $\pm 10^\circ$
Sensor resolution @ 2 Hz	0.00056°
Accuracy:	
Pol. MPE*	$\pm 0.002^\circ$
Lin. MPE*	$\pm 0.004^\circ$
Offset temperature dependency	$\pm 0.002^\circ / ^\circ\text{C}$
Power supply	from 8 to 28 Vdc
Signal output	RS485, Modbus RTU protocol
Temp. operating range	-30°C to $+70^\circ\text{C}$
Overall dimensions (LxWxH)	151 x 106 x 49 mm (including connectors)
Material and IP class	anodized aluminum, IP67

ACCESSORIES

OS540AP3D02	Fine adjustment base plate especially recommended for small ranges ($\pm 2.5^\circ$ and $\pm 5^\circ$)
OECAV04V200	Flying cable for New Leonardo readout for D-Tiltmeter direct reading
OEPD023IP10	Junction box for digital sensor chains
OEPM010IP10	Measuring box for digital sensors chain

(*) MPE is the Maximum Permitted Error on the measuring range (FSR). In the Calibration Report, the accuracies of the gauge are calculated using both linear regression (\leq Lin. MPE) and polynomial correction (\leq Pol. MPE).



TILT BEAM SENSORS

The tilt beam sensor consists of a MEMS tiltmeter mounted on a rigid aluminum beam with a defined gauge length. Both ends of the beam are fixed to the structure. This arrangement converts tilt changes to millimeters of movement in order to monitor settlement and heave.

Special support tiltmeter plate allow to use tilt beam horizontal, vertical or inclined.

TILT BEAM SENSORS

MODEL S541MA	uniaxial tilt sensor
MODEL S542MA	biaxial tilt sensor
Application	horizontal, vertical or inclined
Sensor type	MEMS
Range	$\pm 2.5^\circ$, $\pm 5^\circ$, $\pm 10^\circ$
Sensor resolution	0.01% FS
Accuracy: Pol. MPE*	$\pm 0.004^\circ$ for $\pm 2.5^\circ$ range, $\pm 0.006^\circ$ for $\pm 5^\circ$ range, $\pm 0.010^\circ$ FS for $\pm 10^\circ$ range
Signal output	4-20 mA current loop (inclination), Ohm (temperature)
Power supply	18 - 30 V DC
Temp. operating range	-30°C to $+70^\circ\text{C}$
Protection	IP67

DIGITAL TILT BEAM SENSOR

MODEL S541HD	uniaxial digital tilt sensor
MODEL S542HD	biaxial digital tilt sensor
Application	horizontal, vertical or inclined
Sensor type	MEMS
Range	$\pm 2.5^\circ$, $\pm 5^\circ$, $\pm 10^\circ$
Resolution (reading frequency 2 Hz)	0.00056°
Sensor accuracy:	
Pol. MPE ^(*)	$\pm 0.002^\circ$
Lin. MPE ^(*)	$\pm 0.004^\circ$
Signal output	RS485, MODBUS RTU protocol
Power supply	from 8 to 28 Vdc
Temp. operating range	-30°C to $+70^\circ\text{C}$
IP class	IP67

BEAMS

OS7BM100002	1 meter beam
OS7BM200002	2 meter beam
OS7BM300002	3 meter beam
Material	Aluminium
Beam section	40 x 60 mm (WxH)

TILTMETERS



- _LANDSLIDES
- _DAMS
- _UNSTABLE SLOPES
- _PILES
- _DIAPHRAGM WALLS
- _TUNNELING
- _DEEP EXCAVATIONS
- _BRIDGES AND VIADUCTS
- _EMBANKMENTS

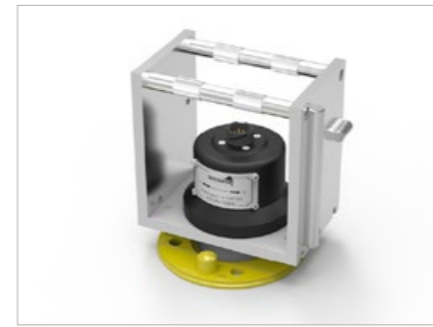

TILLI PORTABLE TILTMETER

TILLI is a rugged portable tiltmeter. It consists of a durable stainless steel frame with an aluminium housing containing a self compensated MEMS tilt sensor. The surfaces of the frame are machined to allow the accurate positioning of the tiltmeter during successive measurements. A single TILLI can be used to measure any number of pre-installed tilt plates.

OSCLIN150H0 TILTMETER CE

TILLI sensor	uniaxial self compensated MEMS
Measuring range	±15° from the vertical
Sensor resolution @ 2 Hz	0.00056° (0.01 mm/m)
Repeatability	< ±0.003°
Temperature dependency	< ±0.005% FS /°C
Temp. operating range	-30°C to +70°C
Material stainless	Stainless steel frame anodised AL sensor housing
Weight	3 Kg (TILLI only)
Carrying case	IP68 shock-resistant plastic



Measuring activity with TILLI

OSCLTP14B00 TILT PLATE

Material	Brass
Dimensions (OD x thickness)	135 x 23 mm



SUBMERSIBLE MEMS TILTMETER

Submersible tiltmeters are designed for in-place applications on surfaces below the water level or where flooding may occur. Submersible tiltmeters are equipped with MEMS sensors and mounted on a base plate in order to monitor tilt changes in either one or two axial planes perpendicular to the surface of the base plate.

AVAILABLE MODELS CE

MODEL S521MA	uniaxial
MODEL S522MA	biaxial
Sensor type	self compensated MEMS
Available ranges	±5°, ±10°
Sensor resolution @ 2 Hz	0.00056° (0.01 mm/m)
Accuracy (MPE*)	< ±0.07% FS with ±5° FS < ±0.05% FS with ±10° FS
Temperature dependency	< ±0.005% FS /°C
Signal output	4-20 mA current loop
Power supply	18 - 30 V DC
Temp. operating range	-30°C to +70°C
Overall dimensions	36 x 68 x 245 mm (LxWxH)
Material and protection	stainless steel, IP68 until 1.0 MPa

ACCESSORIES

OS500PF1000
Stainless steel base plate
with three anchors for
wall mounting.
Overall diam: 100 mm



OS500AP3600
"L" shaped base plate for
installation of submersible
tilt meters on sloped
surface.



(*) MPE is the Maximum Permitted Error on the measuring range (FSR). In the Calibration Report, the accuracies of the gauge are calculated using both linear regression (≤ Lin. MPE) and polynomial correction (≤ Pol. MPE).

EXAMPLE OF SUBMERSIBLE TILTMETER INSTALLATION

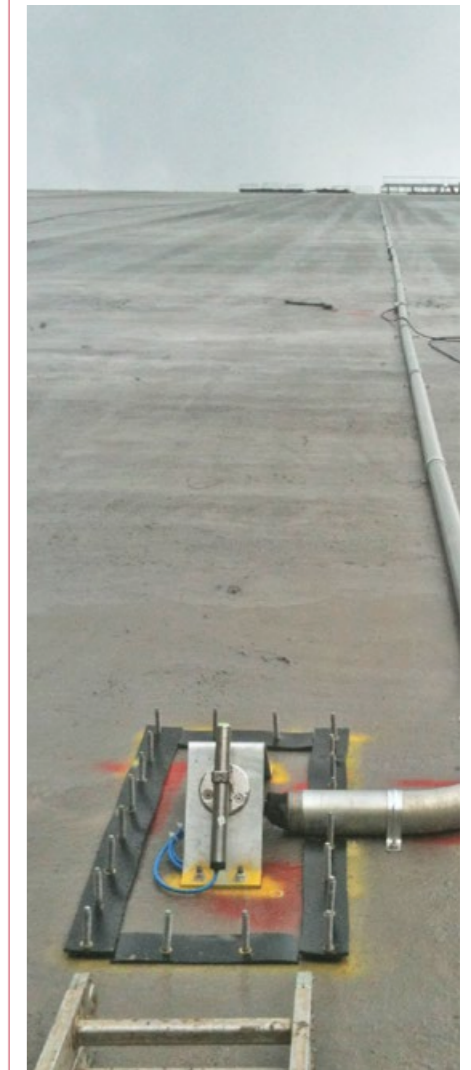

Submersible tilt meter installed on up-stream face of Sogamoso Dam - Colombia (190mt high)

SETTLEMENT GAUGES

- _ BUILDINGS
- _ EMBANKMENTS
- _ FOUNDATIONS
- _ CIVIL STRUCTURES
- _ TUNNELING
- _ CONCRETE AND EARTHFILL DAMS

Project:
Boguchanskaya HPP
Russia



H-LEVEL LIQUID LEVEL SYSTEM

The H-Level gauge consists of a compact enclosure containing a high sensitivity relative pressure transducer and a small reservoir designed to avoid any air bubble creation. The LLS system consists of a series of H-Level gauges interconnected by a liquid filled tube to a reference tank; barometric air compensation tube guarantees barometric compensation on the whole system avoiding data errors caused by the air pressure variations near the gauge.

DIGITAL H-LEVEL GAUGES

OHLEV050D02	DIGITAL H-LEVEL GAUGE, 500 mm FS
OHLEV100D02	DIGITAL H-LEVEL GAUGE, 1000 mm FS
Sensor type	capacitive ceramic sensor
Measuring range	500 or 1000 mm H ₂ O (2000 mm on request)
Gauge resolution	0.002% FS
Gauge accuracy (MPE*)	±0.07% FS
(thermal effects not included)	
Offset temp. dependency	< ±0.01 mm/°C with 500mm range < ±0.03 mm/°C with 1000mm range
Internal sensors (embedded on electronic board)	Temperature, humidity and supply voltage monitor
Output signal	RS-485, Modbus RTU protocol
Operating temperature	-20°C to +70°C
Housing dimensions (WxHxD)	75 x 175 x 50 mm
Housing material	Anodized aluminum

(*) MPE is the Maximum Permitted Error on the measuring range (FSR)

ANALOGUE H-LEVEL GAUGES

OHLEV050002	H-LEVEL GAUGE, 500 mm FS
OHLEV100002	H-LEVEL GAUGE, 1000 mm FS
Sensor type	capacitive ceramic sensor
Measuring range	500 or 1000 mm H ₂ O (2000 mm on request)
Gauge resolution	infinite
Gauge accuracy (MPE*)	±0.15% FS with 500mm range
(thermal effects not included)	±0.10% FS with 1000mm range
Offset temp. dependency	< ±0.05 mm/°C with 500mm range < ±0.15 mm/°C with 1000mm range
Output signal	4-20mA (pressure), Ohm (temperature)
Operating temperature	-20°C to +60°C
Housing dimensions (WxHxD)	75 x 175 x 50 mm
Housing material	Anodized aluminum

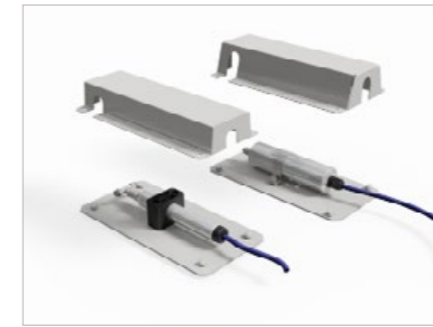

MULTIPOINT SETTLEMENT SYSTEM

The multipoint settlement system consists of a number of hydraulic settlement gauges connected by tubing to a reference tank located on a higher, stable ground. The settlement gauge is a pressure transducer with vibrating wire or capacitive technology, mounted on a plate with a protective cover. Depending on the requirement, the settlement system can be installed with just a single gauge or with multiple gauges.

OD422R000MA ELECTRICAL GAUGE CE

Sensor type	capacitive vented pressure transducer with built-in thermistor
Measuring range	20 kPa, 50 kPa, 100 kPa 1.75 m, 4.4 m, 8.8 m (with Sisgeo liquid mix)
Sensor sensitivity	<0.006% FS
Sensor total accuracy ⁽¹⁾	<±0.1% FS
Output signal	4-20 mA (pressure), Ohm (thermistor)

OD422R000VW VIBRATING WIRE GAUGE CE

Sensor type	vibrating wire non-vented pressure transducer with built-in thermistor
Measuring range	170 kPa, 350 kPa, 700 kPa 15.0 m, 30.9 m, 61.8 m (with Sisgeo liquid mix)
Sensor sensitivity	0.025% FS
Sensor accuracy	< ±0.25% FS
Output signal	frequency (pressure), Ohm (thermistor)

The operating principle is based on the pressure variation caused by the change in height of a column of liquid. Subsequent height variations occurring between the datum point and the measuring points cause proportional variations of the hydraulic level of each settlement gauge.

COMPONENTS AND ACCESSORIES

OD422SERB00	SIMPLE REFERENCE VESSEL
OD422S08000	REFERENCE TANK
0MEPR0106000	BAROMETER
0TUNY060800	6 MM PA TUBE, ID/OD 6/8 MM
1000LIGL100	SISGEO LIQUID MIX
1000COPE300	HYDRAULIC CIRCUIT INSULATION
OD422SAT200	SATURATION DEVICE



PRISMS AND TARGETS

Mini prisms are supplied with aluminum "L" shaped support offering high accuracy and small dimensions. Optical targets are available with various supports, single or double-faced, so as to suit a large number of applications. Simple bolt and benchmark can be supplied to complete the topographic accessories for structural and convergence surveying.

OGMP1040000 MINIPRISM

Max I.R. range	2000 m (7000 ft)
Prism diameter	24 mm
Prism body dimensions	Ø 60 mm, thickness 27 mm
Diameter	34 mm
L-support	aluminum, 12 x15 mm section
Overall dimensions	76 x 90 x 27 mm

OPTICAL TARGETS

OGCTR005000	REMOVABLE TARGET with rotary plate
OGCTR38ADP0	3/8" G PLASTIC STUD ADAPTOR for OGCTR0050000
OGCTR0050TS	TARGET 50 x 50 MM with rotary plate and M6 anchor
OGCTR0050L0	TARGET 50 x 50 MM with aluminium "L" support
OGCSH165000	SHEET OF N.16 ADHES. REFLECTOR reflector dimensions 50 x 50 mm

TOPOGRAPHIC BOLTS

	0GBM025SS00 Head dimensions: Ø 25 mm, height 5 mm Body diameter: Ø 10 mm Total length: 55 mm Material: stainless steel
	0GBM000SS00 Head: removable, Ø 20 or Ø 40 mm Body dimension: 8 x 15 mm Total length: 177 mm Material: galvanized and stainless steel



SETTLEMENT GAUGES

- _ BUILDINGS
- _ EMBANKMENTS
- _ FOUNDATIONS
- _ CIVIL STRUCTURES
- _ TUNNELING
- _ CONCRETE AND EARTHFILL DAMS

Project:
Chuquicamata Mine
Chile



T-REX INCREMENTAL EXTENSOMETER

T-REX is a removable extensometer which has been designed for incremental measurements along the axis of an inclinometer casing equipped with ring magnets. Thanks to the positioning device, T-REX digital probe gives accurate measurements. KLION analyzer software includes a smoothing technique that allows the "best fit" in order to evaluate the real behaviour of the soil movements

OEX45100DS DIGITAL T-REX SYSTEM

T-REX digital extensometer offers several advantages:

- wide measuring range (± 40 mm displacement per meter) which allows applications either in soil or rock
- fully compatible with Sisgeo BRAIN inclinometer system (cable, connector and BRAIN APP)
- no mechanical contact between probe and targets
- combined with inclinometer permits 3-D deformation borehole profile

Measuring base	1.000 mm
Measuring range	± 40 mm
Probe repeatability	0.01 mm/m
Signal output	RS485 Modbus RTU protocol
Operating temperature	-30°C $+75^{\circ}\text{C}$
IP class	IP68 up to 2.0 MPa
Dimensions	\varnothing 40 mm, length 1664 mm
Material	aluminum body and steel parts

BRAIN REEL AND APP

Measurements are performed with B.R.A.IN bluetooth reel (product code OS2RC6000B0), available in different length from 30m up to 250m. APP available for both Android and Apple devices.

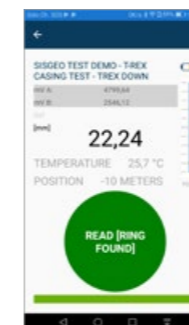
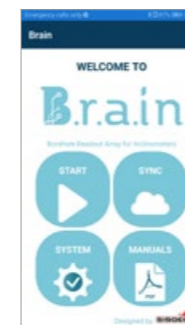

DEX IN-PLACE EXTENSOMETER

DEX extensometers are used in conjunction with inclinometer casings for the automatic monitoring of settlement or heave. Strings of DEX extensometer are joined together with stainless steel wire or rods. DEX probes are placed at different depths where the settlement is likely to occur with reference points at the top or bottom of the casing.

DIGITAL DEX SPECIFICATIONS

ODEX350100D	Range 100 mm, length 1230 mm
ODEX350500D	Range 500 mm, length 1230 mm
ODEX351000D	Range 1000 mm, length 1730 mm
Sensor resolution	0.0001 mm (with OMNIAlog)
Sensor accuracy	$< \pm 0.25\%$ FS for 100mm range $< \pm 0.08\%$ FS for 500 and 1000mm ranges
Temperature sensor	accuracy $\pm 1^{\circ}\text{C}$
Int. humidity sensor	accuracy $\pm 5\%$ RH
Signal output	RS485 with Modbus RTU Protocol
Operating temperature	-30°C $+70^{\circ}\text{C}$
Environmental	IP68 (up to 1.0 MPa)
Outer diameter	35 mm

ANALOGUE DEX SPECIFICATIONS

ODEX35010000	Range 100 mm, length 1230 mm
ODEX35050000	Range 500 mm, length 1230 mm
ODEX35100000	Range 1000 mm, length 1730 mm
Sensor resolution	0.005 mm
Sensor accuracy	$< \pm 0.25\%$ FS for ODEX35010 $< \pm 0.08\%$ FS for ODEX35050 and ODEX35100
Signal output	0-10 V DC
Operating temperature	-30°C $+70^{\circ}\text{C}$
Environmental	IP68 (up to 1.0 MPa)
Outer diameter	35 mm



DEX-S 3D IN-PLACE EXTENSOMETER

DEX-S are in-place extensometers equipped with biaxial MEMS tilt sensor for 3-D borehole displacement monitoring. Mixed chains of DEX, DEX-S and IPI give a cost effective solution for comprehensive borehole monitoring. DEX-S probes connected to OMNIAlog datalogger provides automatic monitoring of unattended locations and alerting.

DIGITAL DEX-S SPECIFICATIONS

ODEX35S115D	Axial range 100 mm, Tilt range $\pm 15^{\circ}$
ODEX35S130D	Axial range 100 mm, Tilt range $\pm 30^{\circ}$
SETTLEMENT SENSOR	
Measuring range	± 50 mm (100 mm)
Linearity	$< \pm 0.30\%$ FS
Sensor accuracy	$< \pm 0.25\%$ FS
TILT SENSOR	
Technology	MEMS inclinometer
Type	Biaxial
Sensor resolution @ 2 Hz	0.00056° (0.01 mm/m)
Sensor accuracy	$\pm 0.015\%$ FS (for $\pm 15^{\circ}$ range) $\pm 0.020\%$ FS (for $\pm 30^{\circ}$ range)
Temperature dependency	$< \pm 0.002^{\circ} / ^{\circ}\text{C}$
TEMPERATURE GAUGE	
Measuring range	-40°C to $+125^{\circ}\text{C}$
Accuracy	$\pm 1^{\circ}\text{C}$ (with temperature range -10°C to $+85^{\circ}\text{C}$)
SIGNAL OUTPUT	RS485 with Modbus RTU Protocol



SETTLEMENT GAUGES

- _ BUILDINGS
- _ EMBANKMENTS
- _ FOUNDATIONS
- _ CIVIL STRUCTURES
- _ TUNNELING
- _ CONCRETE AND EARTHFILL DAMS

Project:
Afshar Dam
Turkey



FIXED EXTENSOMETER

Fixed extensometer is usually defined as a device placed in an embankment fill or inside a borehole for monitoring settlement or heave between two points. Optical surveying of the top of the riser rod provides precise monitoring. Electrical transducers can be used for automatic readings in remote inaccessible locations.

SETTLEMENT PLATFORM

The primary advantage of the settlement platform is its simplicity. The settlement platform consists of a galvanized square plate to which a riser settlement rod is attached. An anti-friction corrugate pipe is placed around the riser rod. Optical levelling measurements, on the survey point mounted on the top cap, provide records of plate elevation.

OD100A20000	2 M SECTION RISER ROD
OD111PV5500	CORRUGATE PIPE, OD 55 mm
OD100B05000	SQUARE PLATE 500 x 500 mm
OD100T15000	TOP CAP AND SURVEY POINT

TELL-TALE EXTENSOMETER

The tell-tale extensometer is a single-point extensometer which is typically used for precise monitoring of ground surface settlement or heave. It consists of a stainless steel bottom anchor to which a string of riser measuring rods is attached. An anti-friction corrugate pipe is placed around the riser rods. Optical levelling measurements of the top head of the riser rod provide a measure of ground settlement. Sliding rings are placed at both ends in order to prevent down drag forces on the rod.

OD100A20000	2 M SECTION RISER ROD
OD111PV5500	CORRUGATE PIPE, OD 55 mm
OD100TT6000	BOTTOM ANCHOR
OD100TT0100	TOP CAP AND SURVEY POINT
OD100TTEL10	DTM MEASURING HEAD

ODTM0000000 DTM ELECTRICAL TRANSDUCERS

DTM electrical transducers can be mounted on either settlement platforms or the tell-tale extensometers.

Range	250 mm, 500 mm, 1000 mm
Sensor accuracy	±0.25% FS
Output signal	4-20 mA current loop

SIGGEO.COM

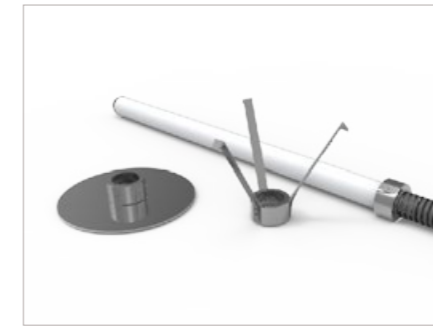

MAGNET EXTENSOMETER (BRS)

Magnet extensometer is a system for measuring either settlement or heave at various depths in soil and embankments. The system consists of an access tube with external corrugated pipe and ring magnets. Readings are obtained lowering in the access tube a portable readout equipped with a reed switch probe.

COMPONENTS

OD111P30000	3 M SECTION ACCESS TUBE
OD111PV5500	CORRUGATED PIPE, OD 55 MM
OD111TF6000	TELESCOPIC END AND DATUM
OD111TS1000	SUSPENSION HEAD
OD111AF6000	SPRING MAGNET RING
	ID 60 mm, max span 300 mm
OD111AR6000	MAGNET SETTLEMENT PLATE
	iD 60 mm, plate OD 300 mm

C121 PORTABLE READOUT

OC121005000	READOUT, 50 M FLAT CABLE
OC121010000	READOUT, 100 M FLAT CABLE
OC121015000	READOUT, 150 M FLAT CABLE
OC121KITR00	DIPPING PROBE SPARE KIT
Probe dimensions	OD 16 mm, length 250 mm
Cable division	millimetre, class II ECC
Cable sheath	nylon
System accuracy	±1 mm
Temp. operating range	-40°C +80°C

EXAMPLE OF MAGNET EXTENSOMETER COLUMN

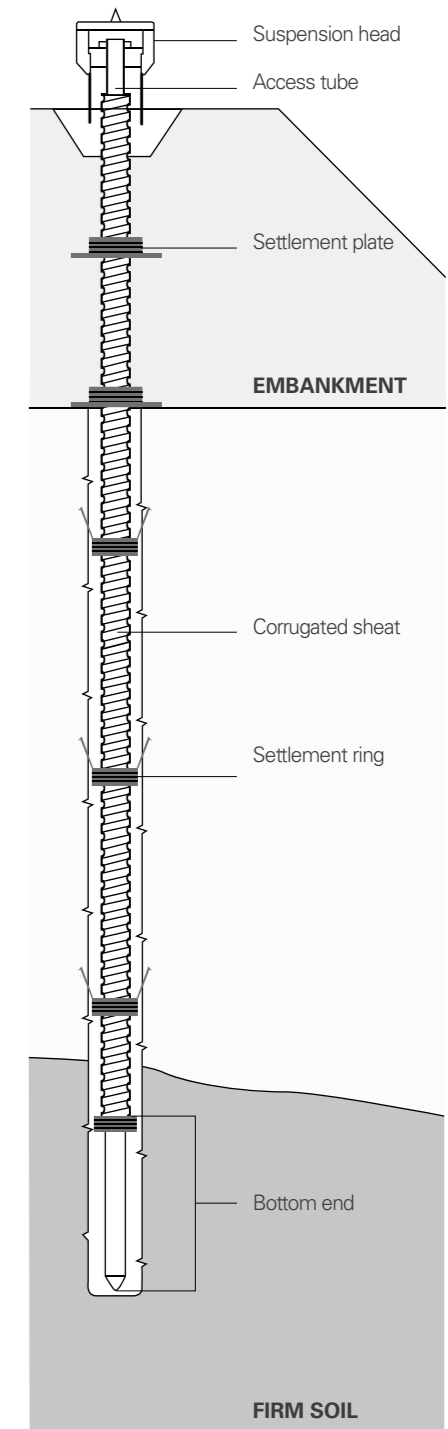

PRESSURE & LOAD CELLS



- _ EMBANKMENTS
- _ TUNNELING
- _ CONCRETE MASS
- _ EARTH FILL DAMS
- _ PILES
- _ DIAPHRAGM WALLS
- _ DEEP EXCAVATIONS
- _ BRIDGES AND VIADUCTS



Project:
MRT Blue Line extension
Bangkok - Thailand

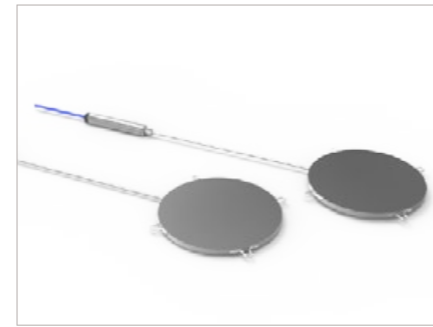

EARTH PRESSURE CELLS

Earth pressure cells are utilized to monitor total pressure in earthfill dams and embankments or in the interface between the structure and the excavation wall.

The stress applied to the pad is converted into an electrical signal via the pressure transducer and can be remotely read with a variety of portable readout units or dataloggers.

AVAILABLE MODELS CE

MODEL L143D	vibrating wire technology
Full scales	350, 500, 700 kPa 1, 1.7, 2, 5, 7, 10 MPa
Sensitivity	0.03% FS
Accuracy (MPE*)	< ±0.25% FS
Signal output	frequency (VW), resistance (T)
Pressure pad size	diameter 230 mm thickness 12 mm
Transducer size	OD 28 mm, 180 mm long
Material	Stainless steel
Operating temp. Range	-20°C +80°C
Weight	0.6 kg

MODEL L141D	piezo resistive technology
Full scales	200, 500 kPa 1, 2, 5, 10 MPa
Sensitivity	0.002% FS
Accuracy (MPE*)	< ±0.25% FS
Signal output	4-20 mA current loop
Pressure pad size	diameter 230 mm thickness 13 mm
Transducer size	OD 28 mm, 180 mm long
Material	Stainless steel
Operating temp. Range	-20°C +80°C
Weight	0.6 kg

(*) MPE is the Maximum Permitted Error on the measuring range (FSR). In the Calibration Report, the accuracies of the gauge are calculated using both linear regression (≤ Lin. MPE) and polynomial correction (≤ Pol. MPE).

SISGEO.COM

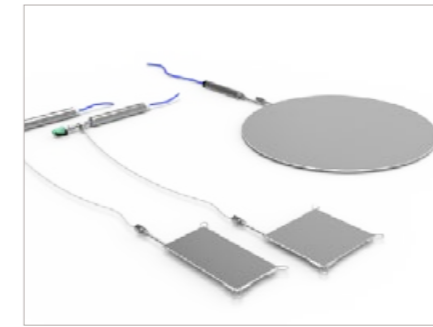

HYDRAULIC PRESSURE CELLS

Hydraulic pressure cells are designed to measure stress in mass concrete or in the interface between the structure and the excavation wall. They are filled under vacuum with de-aired oil that guarantees the maximum rigidity.

A re-pressurizing device is used in order to maintain close contact when the concrete has cured.

AVAILABLE PRESSURE PADS

0L111151500	for radial stress in concrete
Pad size	150 x 150 mm
Working pressure	up to 5 MPa
0L111102000	for tangential stress in concrete
Pad size	100 x 200 mm
Working pressure	up to 20 MPa
0L111204000	for contact soil/rock-structure
Pad size	200 x 400 mm
Working pressure	up to 5 MPa
0L111D05000	for contact soil-concrete
Pad size	circular 500 mm OD
Working pressure	up to 1 MPa

AVAILABLE TRANSDUCERS CE

MODEL PK45H	VW pressure transducers
Full scales	350, 500, 700 kPa, 1, 1.7, 2, 5, 7, 10, 20 MPa
Sensitivity	0.03% FS
Accuracy (MPE*)	< ±0.25% FS
Output signal	frequency (VW), resistance (T)
Operating temp. range	-20°C +80°C
Transducer size	OD 27 mm, 180 mm long
MODEL P252A	electrical pressure transducers
Full scales	200, 500 kPa, 1, 2, 5, 10, 20 MPa
Sensitivity	0.002% FS
Accuracy (MPE*)	< ±0.20% FS
Output signal	4-20 mA current loop
Operating temp. range	-20°C +80°C
Transducer size	OD 27 mm, 180 mm long

EXAMPLE OF EARTH PRESSURE CELLS INSTALLATION

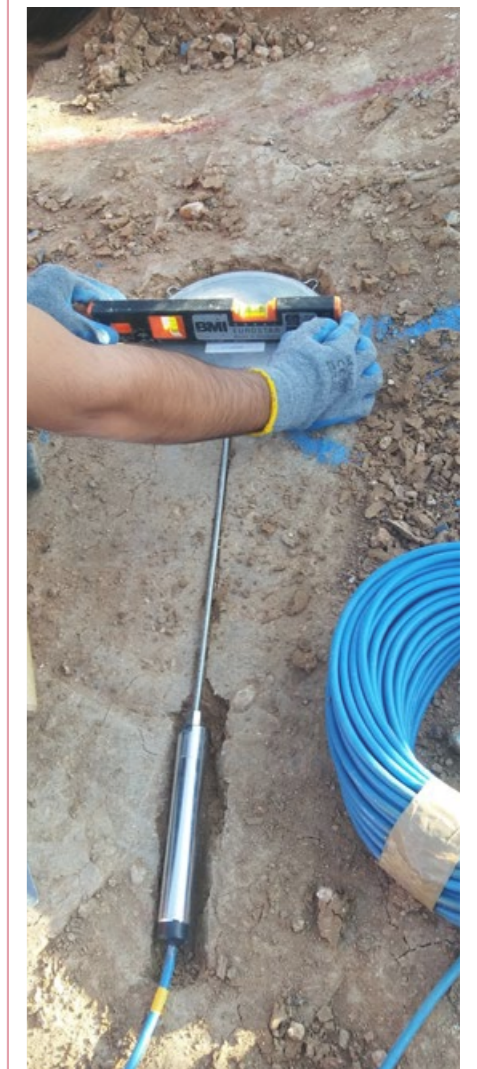

PRESSURE & LOAD CELLS



- _ EMBANKMENTS
- _ TUNNELING
- _ CONCRETE MASS
- _ EARTH FILL DAMS
- _ PILES
- _ DIAPHRAGM WALLS
- _ DEEP EXCAVATIONS
- _ BRIDGES AND VIADUCTS



Project:
Retaining wall in Adler Airport
Russian Federation



HYDRAULIC ANCHOR LOAD CELLS

Hydraulic anchor load cells are utilized to monitor loads in tiebacks, rock bolts and cables. The pressure pad between the plates is filled, under high vacuum, with deaired oil. The load is directly measured in KN through a Bourdon manometer. Electrical conversion using pressure transducer is also available for remote readings.

GAUGE MANOMETER MODEL

OL2M04030H0	300 KN, ID 40 MM, OD 140 MM
OL2M07050H0	500 KN, ID 71 MM, OD 163 MM
OL2M09075H0	750 KN, ID 92 MM, OD 196 MM
OL2M11100H0	1000 KN, ID 110 MM, OD 231MM
OL2M13100H0	1000 KN, ID 138 MM, OD 244 MM
OL2M16150H0	1500 KN, ID 165 MM, OD 293 MM

Overload	120% with less than 2% FS zershift
Manometer accuracy	class ±1.5% FS
Material	AISI 304 stainless steel
Comp. temp. range	-35°C +60°C

ELECTRICAL MODEL

OL2E0705000	500 KN, ID 71 MM, OD 163 MM
OL2E0907500	750 KN, ID 92 MM, OD 196 MM
OL2E1110000	1000 KN, ID 110 MM, OD 231 MM
OL2E1310000	1000 KN, ID 138 MM, OD 244 MM
OL2E1615000	1500 KN, ID 165 MM, OD 293 MM

Overload	120% with less than 2% FS zershift
Accuracy	±1% FS
Signal output	4-20 mA current loop
Temperature drift	0.05 % FS / °C
Material	AISI 304 stainless steel
Comp. temp. range	-35°C + 60°C



OL2E Electro-hydraulic anchor load cell

SISGEO.COM



ELECTRIC ANCHOR LOAD CELLS

Electrical resistance anchor load cells consist of a ring shaped stainless steel body which incorporates from 8 to 16 electrical resistance strain gauges in a full bridge configuration. The cell design minimizes the sensitivity to the eccentric load. A very stiff distribution plate is required, in order to ensure that the load is applied equally on the anular loading surface of the cell.

AVAILABLE MODELS



OL204V03000	300 KN, ID 40 MM, OD 155 MM
OL205V05000	500 KN, ID 50 MM, OD 155 MM
OL207V05000	500 KN, ID 71 MM, OD 155 MM
OL207V07500	750 KN, ID 71 MM, OD 155 MM
OL211V07500	750 KN, ID 110 MM, OD 200 MM
OL212V10000	1000 KN, ID 120 MM, OD 220 MM
OL216V15000	1500 KN, ID 165 MM, OD 260 MM
OL219V18000	1800 KN, ID 190 MM, OD 300 MM
OL222V25000	2500 KN, ID 225 MM, OD 340 MM

Overload	150%
Sensitivity	0.06% FS
Accuracy	< ±0.5% FS
Thermal zero shift	< 0.005% FS / °C
Signal output	1.5mV/V at FS or 2 mV/V at FS
Power supply	from 2V DC to 10V DC
Operating temp. range	-30°C +70°C
Comp. temp. range	-30°C +70°C
Material	stainless steel 17-4 PH

DISTRIBUTION PLATES

OL20040PD00	centre hole 40 mm, OD 110 mm
OL20050PD00	centre hole 50 mm, OD 110 mm
OL20071PD00	centre hole 71 mm, OD 110 mm
OL20110PD00	centre hole 110 mm, OD 155 mm
OL20120PD00	centre hole 120 mm, OD 180 mm
OL20165PD00	centre hole 165 mm, OD 210 mm
OL20190PD00	centre hole 190 mm, OD 250 mm
OL20225PD00	centre hole 231 mm, OD 290 mm

ACCESSORIES

OEC0N07MV00	MIL male connector with cap
OELC420MA00	4-20 mA transmitter (2 wires)



ELECTRO-HYDRAULIC LOAD CELLS

This model of load cells is used to monitor stresses in steel linings, piles and support beams. They consist of a pressure pad connected to a pressure transducer. The pressure pad consists of two stiff stainless steel plates saturated by de-aired oil. Special distribution plates are also available for a better load distribution.

L2CE ELECTRO-HYDRAULIC LC



OL2CE019000	1900 KN, OD 209 MM
OL2CE030000	3000 KN, OD 264.5 MM
Accuracy(*)	< ±1% FS
Signal output	4-20 mA current loop
Temp. operating range	from -20° to +80°C
Protection Class	IP 68 up to 100 KPa
Material	stainless steel
Power supply	from 9 to 30 V DC
Overall size (ODxLxH)	295 x 365 x 36,5 mm OL2CE019 355 x 421 x 36,5 mm OL2CE030

(*) linearity, hysteresis and repeatability

L2CT-L2CX SOLID LOAD CELLS



Specially designed for pile testing, L2CT model have higher accuracy but a large encumbrance; L2CX model have a good accuracy and smaller dimensions.

MODEL	L2CT
Full scales	5000 KN, 8000 KN, 10000 KN
Accuracy	200 mm, 250 mm, 300 mm
Height	< ±0.1% FS
Output signal	2 mV/V at FS
Temp. operating range	-20°C +70°C
Protection Class	IP 65
MODEL	L2CX
Full scales	3000 KN, 4000 KN, 5000 KN
Height	110 mm (for all full scales)
Accuracy	< ±0.5% FS
Output signal	2 mV/V at FS
Temp. operating range	-20°C +70°C
Protection Class	IP 67

EXTENSOMETERS & JOINTMETERS

- _ TUNNELING
- _ DAMS
- _ HISTORICAL BUILDINGS
- _ EMBANKMENTS
- _ DEEP EXCAVATIONS
- _ LANDSLIDES
- _ BRIDGES AND VIADUCTS

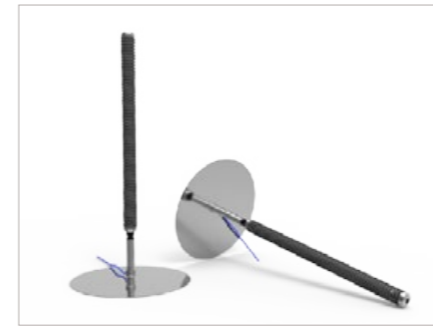

EMBANKMENT EXTENSOMETERS

Embankment (soil) extensometers are used to measure soil strains in large earth structures. The system consists of a number of anchor plates connected through extension rods to a VW displacement transducer. Connected to a data acquisition system, they provide an automatic real time monitoring and alerting.

SYSTEM COMPONENTS

OD2320BM100	EXTENSION ROD, 1 M
OD2320BM200	EXTENSION ROD, 2 M
OD2320BM300	EXTENSION ROD, 3 M
OD111PV5500	PVC CORRUGATE
	ANTIFRICTION SLEEVE
OD232AN5000	ANCHOR PLATE, DIAM 500 MM
OD232AN5500	ANCHOR PLATE, 500 x 500 MM

MEASURING ELEMENTS

OD232T050VW	50 mm (±25 mm) range
OD232T100VW	100 mm (±50 mm) range
OD232T150VW	150 mm (±75 mm) range
Type of sensor	vibrating wire transducer
Measuring range	50, 100, 150 mm
Sensitivity	<0.025% FS
Accuracy (MPE*)	< ±0.30% FS
Signal output	frequency (VW), resistance (T)
Typical frequency range	2250 - 3000 Hz
Operating temperature	-20°C +80°C
Material	stainless steel
Protection	IP68 up to 1.0 MPa
Signal cable	OWE104X20ZH

(* MPE is the Maximum Permitted Error on the measuring range (FSR). In the Calibration Report, the accuracies of the gauge are calculated using both linear regression (≤ Lin. MPE) and polynomial correction (≤ Pol. MPE).

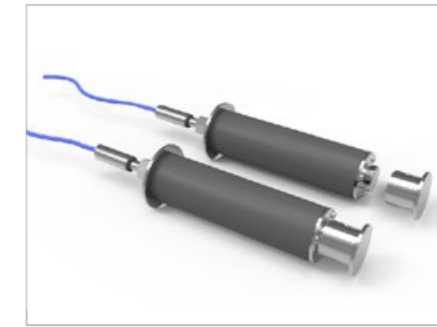

EMBEDMENT JOINTMETERS

Embedment jointmeters are usually installed across the joints in concrete dams in order to measure relative movement between two concrete blocks. Their design allows them to be installed directly onto the formwork. The internal VW displacement transducer is assembled at middle range allowing movements in both directions.

AVAILABLE MODELS

OD314C025VW	VW EMBEDMENT JOINTMETER, 25 MM RANGE
OD314C050VW	VW EMBEDMENT JOINTMETER, 50 MM RANGE
OD314C100VW	VW EMBEDMENT JOINTMETER, 100 MM RANGE
OD314C150VW	VW EMBEDMENT JOINTMETER, 150 MM RANGE

TECHNICAL CHARACTERISTICS

Type of sensor	vibrating wire transducer
Measuring range	25, 50, 100, 150 mm
Sensitivity	<0.025% FS
Total accuracy	< ±0.5% FS
Signal output	frequency (VW), resistance (T)
Operating temperature	-20°C +80°C
Material	stainless steel

EMBEDMENT JOINTMETERS: INSTALLATION PROCEDURES

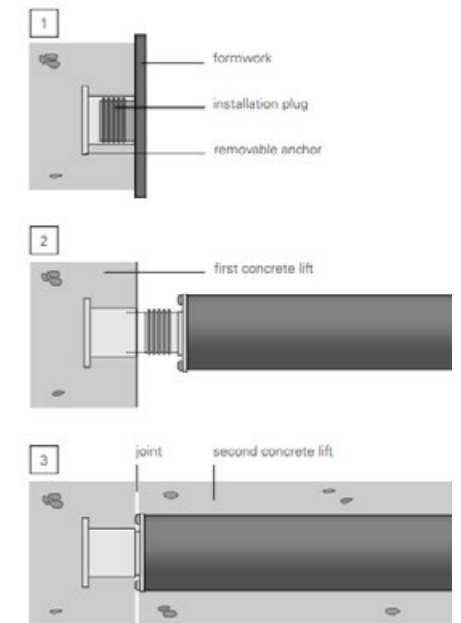

- 1 The removable anchor is embedded in the first pour. A plug keeps concrete out of the anchor.
- 2 After the plug is removed, the transducer body is screwed into the anchor and embedded in the second pour of concrete.
- 3 Now the instrument spans the joint between two blocks of concrete.

EXTENSOMETERS & JOINTMETERS

- _ TUNNELING
- _ DAMS
- _ HISTORICAL BUILDINGS
- _ EMBANKMENTS
- _ DEEP EXCAVATIONS
- _ LANDSLIDES
- _ BRIDGES AND VIADUCTS



MULTIPOINT ROD EXTENSOMETER (MPBX)

Multipoint rod extensometers (MPBX) are installed in boreholes in order to monitor displacements at various depths using rods of different materials and lengths. A pre-set length of measuring rod is inserted into a nylon tube to avoid soil friction and its end is fixed to a steel groutable anchor. Displacements are read with linear transducers (DTE) or with a digital gauge.

AVAILABLE MODELS

OD222AC00A0	s/steel or invar rods, DTE ≤ 100 mm
OD222AC00B0	s/steel or invar rods, DTE > 100 mm
OD222F600A0	fibreglass rods, DTE ≤ 100 mm
OD222F600B0	fibreglass rods, DTE > 100 mm
Number of bases	1 (single), from 2 to 7 (multiple)
Multiple head top tube	OD 120 mm
Extensometer rods	fibreglass pre-assembled stainless steel, 2 m sections
Protective sleeve	nylon 11 (riksan), OD 12 mm

GROUTABLE ANCHORS

Groutable anchors are supplied with all MPBX where packer anchors are not requested.

material	galvanized steel rebar
Diameter / length	Ø 16 mm / 400 mm (MPBX with fibreglass rods) Ø 22 mm / 400 mm (MPBX with stainless steel rods)

PACKER ANCHORS

Two models of packer anchors are available, following different drilling diameter: 101 mm (4") and 127 mm (5"). If packer anchors are needed, the following products codes shall be added (max 4 packers for each extensometers):

OD222PKR127	PACKER ANCHOR for Ø 127 mm drillings (one for each measuring base)
-------------	--



DISPLACEMENT TRANSDUCERS FOR MPBX

MPBX measurements can be taken manually with a depth micrometer or remotely through vibrating wire or 4-20mA displacement transducers and a readout or datalogger. Both vibrating wire and 4-20mA transducers are waterproof up to 1.0 MPa and output signals are suitable for long distance transmission.

VIBRATING WIRE TRANSDUCERS CE

ODTE000VW00	VIBRATING WIRE DTE
Range	10, 25, 50, 100, 150, 200 mm
Signal output	frequency (VW), resistance (T)
Accuracy (MPE*)	< ±0.50% FS for 10 and 25 mm range < ±0.30% FS for 50 mm, 100, 150 and 200 mm range
Typical frequency range	2250 - 3000 Hz
Operating temperature	-20°C +80°C
Protection	IP68 up to 1.0 MPa

POTENTIOMETRIC TRANSDUCERS CE

ODTE1A00000	LINEAR POTENTIOMETER DTE
Range	25, 50, 100, 150, 200 mm
Signal output	4-20 mA current loop
Accuracy (MPE*)	< ±0.30% FS for 25 mm range < ±0.20% FS for 50 and 100 mm range < ±0.15% FS for 150 and 200 mm range
Operating temperature	-20°C +80°C
Protection	IP68 up to 1.0 MPa

ODIGD020000 DIGITAL GAUGE

The digital gauge kit consists of a depth caliper with LCD (readings in metric and imperial units), a set of extension rods and carrying case.

Range	from 0 to 200 mm
Resolution	0.01 mm
Temperature rating	0° C - 40° C
Humidity rating	≤ 80%



MEXID EXTENSOMETER

MEXID are miniaturized MPBX extensometers that allow installation into a 50 mm diameter borehole. Displacement transducers are incorporated into the instrument head so, after positioning and grouting, the external encumbrance is that of the cable gland only (20 mm). Dedicated tubes allow grouting to fix the anchors to rock or soil.

AVAILABLE MODELS CE

OD2MX00D000	fibreglass rods, Digital RS-485, available with 50 and 150 mm range
OD2MX00W000	fibreglass rods, vibrating wire sensors available with 50 and 150 mm range
OD2MX00A000	fibreglass rods, 4-20mA output <u>available only under request</u>
Number of bases	from 1 to 4 (2 to 4 for digital)
Signal output	
OD2MX00A000	4-20 mA current loop
OD2MX00D000	RS-485 Modbus RTU
OD2MX00W000	frequency (VW), resistance (T)
Accuracy	< ±0.20% FS (4-20mA output) < ±0.20% FS (digital) < ±0.30% FS (Vibrating wire)
Head diameter	48.3 mm
Head length	476 mm for 50 mm range 816 mm for 150 mm range
Extensometer rods	fibreglass, OD 7 mm
Protective sleeve	nylon 11 (riksan), OD 12 mm
Groutable anchor	rebar 16 mm OD, 400 mm long
Transducers protection	IP68 (watertight up to 1.0 MPa)

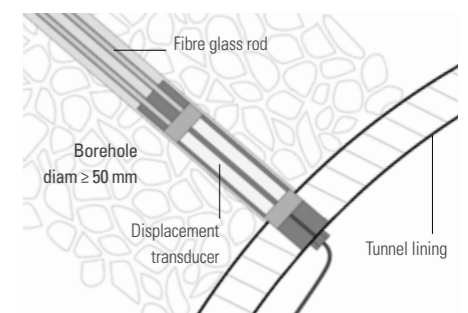

Project:
Letlhakane Mine
Botswana

EXTENSOMETERS & JOINTMETERS



- _ TUNNELING
- _ DAMS
- _ HISTORICAL BUILDINGS
- _ EMBANKMENTS
- _ DEEP EXCAVATIONS
- _ LANDSLIDES
- _ BRIDGES AND VIADUCTS



Project:
Cerro del Águila Dam
Perú



WIRE CRACKMETER AND DEFORMETER

Wire crackmeter is designed to monitor changes in distance between two anchor points located at up to 30 m apart. The wire deformer is used to monitor the displacement between two opposite surfaces (convergence in tunnels, rock masses, etc...). USB deformer incorporates a small logger for automatic monitoring.

OD241A20000 WIRE CRACKMETER CE

Mechanical range	2000 mm
Electrical range	240 mm
Accuracy	±1 mm (depends mainly from the thermal effects on the wire)
Signal output	4-20 mA current loop
Operating temperature	-20°C +80°C
Wire diameter	2 mm, stainless steel
Max. wire tension	8 Kg
Transducer housing	300 x 200 x 185 mm
Target assembly	eyebolt expansion anchor

OD313F00000 WIRE DEFORMETERS CE

Type of sensor	linear potentiometer or vibrating wire
Signal output	4-20 mA current loop frequency (VW), resistance (T)
Measuring range	25 mm (±12.5), 50 mm (±25)
Total accuracy	< ±0.3% FS (4-20mA) < ±0.5% FS (vibrating wire)
Operating temperature	-20°C +80°C
Body diameter	16 mm
Wire	stainless steel, up to 10 meter
Protection	IP68 (watertight up to 1.0 MPa)

OD314FV8000 USB DEFORMETER

Type of sensor	rotating potentiometer
Displacement range	80 mm
Resolution	0.003 mm
Accuracy	< ±0.1% FS
Operating temperature	-10°C +60°C
A/D converter	15 bits
Storage capacity	>51.000 measurements
Battery life	4 years with 1 saving per hour
Protection	IP65

SISGEO.COM

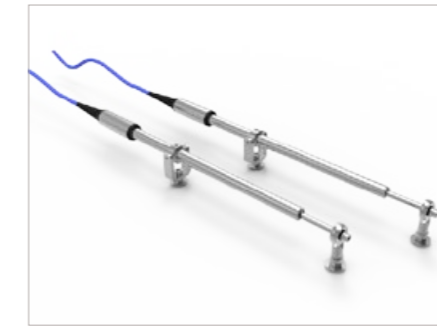

ELECTRICAL AND VW CRACKMETERS

Crackmeters and jointmeters are utilized to monitor movements of surface cracks and joints in concrete structures or rock. The displacement transducer housed in the sensor body is positioned across the joint/crack which enables the measurement changes in distance between the anchors.

ELECTRICAL CRACKMETERS CE

Technology	Linear potentiometer
Full scales (*)	10, 25, 50, 100, 150 mm
Accuracy (MPE**)	< ±0.3% FS
Signal output	4-20 mA current loop
Power supply	12-24V DC
Operating temperature	-20°C +60°C
Sensor diameter	16 mm
Material	stainless steel
Protection	IP68 (watertight up to 100 kPa)

(*) Available up to 260 mm upon request

(**) MPE is the Maximum Permitted Error on the measuring range (FSR)

VIBRATING WIRE CRACKMETERS CE

Technology	Vibrating wire
Full scales (*)	10, 25, 50, 100, 150 mm
Accuracy (MPE**)	< ±0.5% FS
Signal output	frequency (VW), resistance (T)
Operating temperature	-20°C +80°C
Body diameter	16 mm
Material	stainless steel
Protection	IP68 (watertight up to 1.0 MPa)

(*) Available up to 300 mm upon request

(**) MPE is the Maximum Permitted Error on the measuring range (FSR)

ACCESSORIES

OD31Y1DTE00	Y-AXIS STAINLESS STEEL FIXING KIT
OD31Z1DTE00	Z-AXIS STAINLESS STEEL FIXING KIT

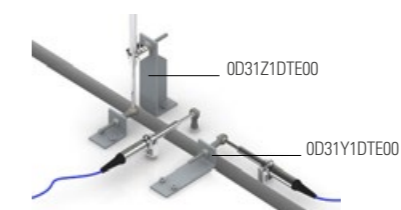

3-D MECHANICAL CRACKMETER

3-D (triaxial) mechanical jointmeters are aimed to monitor joints and cracks. The movements between the two anchors are obtained by mechanical dial gauges. Simple and inexpensive, the TT-1 tell-tale crack monitor, installed across a fissure, allows the crack survey in two directions.

AVAILABLE MODELS

OD3103D3000	3-D CRACKMETER ASSEMBLY
Mechanical range	0-30 mm
Base lengths	200 mm (3-D)
Anchors	2 groutable rebar Ø 16 mm, length 80 mm
Material	Stainless steel and aluminium

OD1630KIT00 DIAL GAUGE KIT

Compatible with	OD3101D3000 OD3103D3000
Measuring range	0-30 mm
Gauge resolution	0.01 mm
Gauge accuracy	±0.05 mm

OD300LINE00 TT-1 CRACK MONITOR

Model	2-D biaxial
Mechanical range	±20 mm (X-axis), ±10 mm (Y-axis)
Resolution	1 mm
Material	polycarbonate

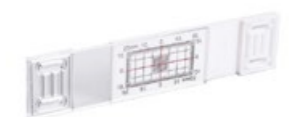

STRAIN-GAUGES & THERMOMETERS

_PILES AND MASS CONCRETE

_CONCRETE STRUCTURES, BEAMS AND COLUMNS

_CONCRETE FOUNDATIONS AND DIAPHRAGM WALLS

_TUNNEL SEGMENTS

_STEEL STRUCTURES, PIPES AND ARCH SUPPORTS

_GRAVITY AND ARCH DAMS

_BRIDGES AND VIADUCTS



VIBRATING WIRE STRAIN-GAUGES

Vibrating wire strain-gauges are used to monitor variation in strain, which allows stress evaluation in steel or concrete structures. A thermistor incorporated into the gauge gives the temperature at the point of measurement allowing temperature compensation. 3-D rosette mounting is also available.

AVAILABLE MODELS



OVK4000VS00	WELDABLE SG
OVK4000VSC0	CONCRETE SURFACE SG
OVK4200VC00	EMBEDMENT SG
OVK4200VCHP	EMBEDMENT SG FOR DEEP APPLICATION
OVK4000SM00	SHOTCRETE SG WITH ADJUSTABLE TENSIONING
Range (nominal)	3000 $\mu\epsilon$ (shotcrete 10000 $\mu\epsilon$)
Signal output	Frequency (strain), Ohm (temperature)
Accuracy	$\pm 0.5\%$ FS ($\pm 3\%$ FS for OVK4000SM00)
Repeatability	$\leq \pm 1 \mu\epsilon$, $\leq \pm 3 \mu\epsilon$ for OVK4000SM00
Coil resistance (nominal)	150 ohm
Embedded thermistor type	NTC 3 k Ω
Temperature range	-20°C + 80°C

ACCESSORIES

OVK42VC3D00	3D rosette mounting block for embedment strain gauges.
OVK400JIG00	Spacing jig for mounting the arc-weldable strain gauges end blocks.
OVK400MB200	Pair of arc-weldable surface mounting blocks.
OVK400COVER	S/steel protective cover with lugs and pair of weldable blocks

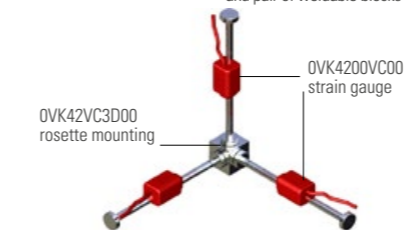

VW strain gauges in 3D configuration

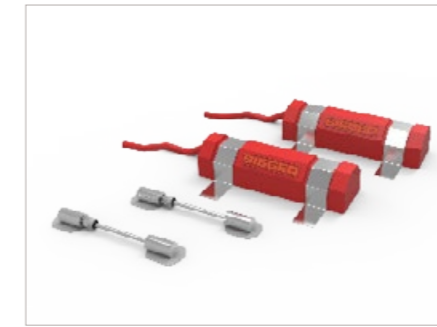

SPOT WELDABLE STRAIN GAUGES

Vibrating wire spot-weldable strain gauges are mainly designed to measure strain on steel surfaces. They consist of a weldable SG and a cover which contains the plucking coil. SG is pre-tensioned during manufacturing at mid range. SG installation is preferred using the spot welder recommended by the manufacturer.

OVK4100VS00 SPOT WELDABLE SG



Active gauge length	47.5 mm
Range (nominal)	$\pm 1500 \mu\epsilon$
Signal output	frequency (VW), resistance (T)
Sensitivity	1.0 $\mu\epsilon$
Accuracy	$\pm 0.5\%$ FS
Stability	0.1% FS/year
Typical frequency	from 600 to 2500 Hz
Coil resistance	150 Ohm
Temperature sensor	NTC thermistor
Thermal coeff. of expansion	5 ppm / °C
Temperature range	-20°C a +80°C

OVK4100VSPO PLUCKING COIL

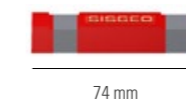

OVK4100VSG0 STRAIN GAUGE ONLY

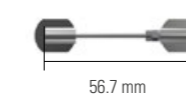

ACCESSORIES AND COMPONENTS

OVK410PSW00	Portable spot-welder for VW spot-weldable strain gauges
OWE104SG0ZH	LSZH signal cable
OVK4100VSG0	Strain-gauge only
OVK4100VSPO	Plucking coil only

EXAMPLE OF EARTH PRESSURE CELLS INSTALLATION



TELT - Tunnel Euralpin Lyon Turin, installation of VW strain gauges within TBM precast concrete element.

_PILES AND MASS CONCRETE

_CONCRETE STRUCTURES, BEAMS AND COLUMNS

_CONCRETE FOUNDATIONS AND DIAPHRAGM WALLS

_TUNNEL SEGMENTS

_STEEL STRUCTURES, PIPES AND ARCH SUPPORTS

_GRAVITY AND ARCH DAMS

_BRIDGES AND VIADUCTS

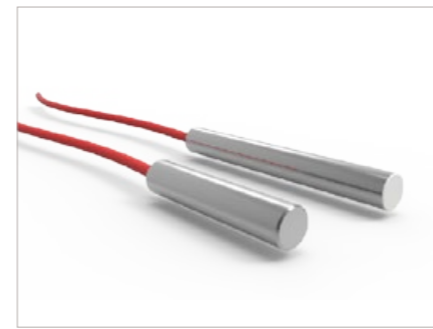

EMBEDMENT THERMOMETERS

Temperature is a very important parameter to measure, so as the evaluation of the influence of thermal effects on the recorded data associated with the structure being monitored. Sisgeo uses three types of technologies to monitor temperature: thermistors, RTDs (Resistance Thermal Detectors) and vibrating wire sensors.

OT111PT1000 PT100 THERMOMETERS

Type of sensor	PT100 platinum resistance
Measuring range	-50°C +80 °C
Resolution	0.1°C
Accuracy	±0.2°C
Diameter	20 mm
Length	100 mm
Body material	stainless steel

OT3800GKA00 THERMISTORS

Type of sensor	NTC thermistor (YSI 44005)
Measuring range	-50°C +80 °C
Resolution	0.1 °C
Accuracy	±0.5 °C
Diameter	12 mm
Length	55 mm
Body material	stainless steel

OT2200VW000 VW THERMOMETER (AVAILABLE ONLY ON REQUEST)

Type of sensor	vibrating wire
Measuring range	-20°C +80 °C
Resolution	0.1 °C
Accuracy	±0.5 °C
Diameter	20 mm
Length	166 mm



TEMPERATURE STRINGS

Temperature strings are often used to monitor the thermal profile in boreholes or mass concrete temperature during curing. They consist of a RTD or thermistor sensors mounted on a length of multicore cable. The spacing between two sensors is customized according to Client requests.

OTS00RTD000 RTD STRINGS

Type of sensor	PT100 platinum resistance
Number of sensor	until N.4 with OWE1160LSZH cable until N.8 with OWE1320LSZH cable
Measuring range	-50°C +80 °C
Resolution	0.1°C
Accuracy	±0.2°C
Sensed section	Ø20 mm, length 180 mm

OTS00NTC000 THERMISTOR STRINGS

Type of sensor	NTC thermistor (YSI 44005)
Number of sensor	until N.8 with OWE1160LSZH cable until N.16 with OWE1320LSZH cable
Measuring range	-50°C +80 °C
Resolution	0.1 °C
Accuracy	±0.5 °C
Sensed section	Ø20 mm, length 180 mm

CABLES FOR TEMPERATURE STRINGS

OWE1160LSZH	LSZH MULTICORE CABLE, 8 PAIRS
OWE1320LSZH	LSZH MULTICORE CABLE, 16 PAIRS
single conductor	tinned copper, CU ETP 5649/88
Inner jacket	flame retardant polyolefin
Outer jacket	technopolymer M1, LSZH
Diameter	9.2 mm for OWE1160LSZH 12.2 mm for OWE1320LSZH

PENDULUMS & READOUT



- _ARCH DAMS
- _CONCRETE DAMS
- _SKYSCRAPERS
- _SLENDER STRUCTURES
- _BELL TOWERS
- _MINARETS

Project:
Emenek Dam
Turkey



DIRECT AND INVERTED PENDULUMS

Direct and inverted pendulums are simple, reliable and accurate systems used to monitor horizontal movements. Commonly utilized in concrete dams, they permit to measure the change in verticality. The inverted pendulum anchored in the foundation combined with the direct pendulum allow to obtain a complete profile of the dam's verticality.

OS911002500 DIRECT PENDULUM

The direct pendulum is a gravity-referenced instrument. It consists of:

- stainless steel cylindrical fluid tank with cover
- wire tensioning weight and damping unit
- upper wire anchor system with rail and sliding block
- turnbuckle for trimming the damping unit position

Tank dimensions	410 mm diam, 415 mm high
Material	stainless steel
Damping fluid (mineral oil)	not supplied

OS912006000 INVERTED PENDULUM

The inverted pendulum provides a fixed datum from which structural movements can be measured. It consists of:

- stainless steel anular damping chamber with cover
- stainless steel floating unit
- adjustable tie bar with 100 mm vertical stroke
- external tube for liquid level survey
- steel ballast for borehole wire anchoring

Tank dimensions	615 mm diam, 497 mm high
Floating unit	allows ± 72 mm movement in any direction
Groutable anchor diameter	75 mm, adjustable from 80 mm to 160 mm by centralized pins, steel.
Material	stainless steel
Damping fluid (mineral oil)	not supplied

OWRAC200000 PENDULUM WIRE

Material	stainless steel
Diameter	2 mm

SISGEO.COM



T-1000 TELEPENDULUM

T-1000 Teleependulum is designed to take automatic readings of the coordinates of pendulum's plumb lines. Thanks to the new optic sensor without any moving parts, it has very high accuracy and resolution and wide measuring range. T-1000 can be settled and read locally with dedicated mobile APP or can be integrated into automatic data acquisition system networks through RS485 or 4-20mA output.

OTELT100000 TELEPENDULUM CE

Measurement principle	optical
Measurement range	X-axis: 0-150 mm (± 75 mm) Y-axis: 0-150 mm (± 75 mm)
Resolution	0.01 mm
Repeatability (both axis):	
in core area ⁽¹⁾	± 0.02 mm
whole measuring area ⁽¹⁾	± 0.05 mm
Accuracy Pol. MPE ⁽¹⁾	
in core area ⁽¹⁾	
for movements < 30mm	± 0.05 mm for both axis
in meas. area ⁽¹⁾	
for movements < 30mm	± 0.10 mm for both axis
in meas. area ⁽¹⁾	
for movements ≥ 30 mm	± 0.25 mm ($\pm 0.15\%$ FS) for both axis
Stability @60 hours	± 0.05 mm
Detectable wire (diameter)	from 0.8 mm to 2 mm best performance with 1 mm wire
Output:	
- Local readings	Mobile APP through Bluetooth 4.2
- Remote monitoring	RS-485 with Modbus RTU protocol ⁽¹⁾ 4-20mA 4-wires

T-1000 APP

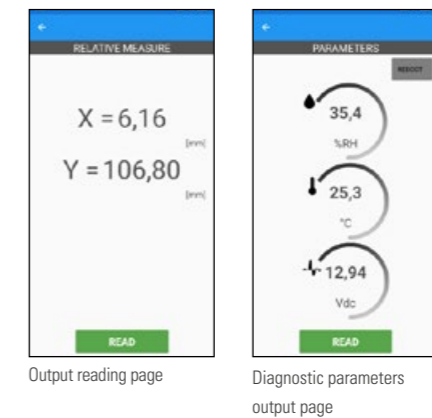

Output reading page

Diagnostic parameters output page

⁽¹⁾ Refer to T-1000 datasheet technical specifications notes

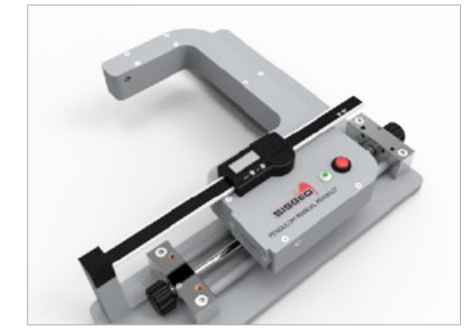

OPTICAL PENDULUM READOUT

The pendulum readout (coordinometer) is a reliable and simple instrument for manual readings of pendulum systems. It allows calculation of the horizontal movements of the pendulum wire and a digital LCD displays the X and Y coordinates in millimetres. It can be utilized for either in-place installation or removable measurements in different locations.

OS9RTB15000 MANUAL READOUT

Measurement area	X-axis: 0-150 mm (± 50 mm) Y-axis: 0-150 mm (± 50 mm)
Gauge resolution	0.01 mm
Gauge accuracy	$< \pm 0.1$ mm
Gauge protection	IP67
Temp. operating range	-20°C +60°C
Material	aluminium
Dimensions	340 x 340 x 115 mm
Weight	3.5 kg

ACCESSORIES

OS9RTPLT100	SUPPORT BASE PLATE
Material	galvanized steel
Dimensions	415 x 415 x 10 mm (LxWxH)
OS9RTFR1000	CALIBRATION FRAME
Material	stainless steel /aluminium
Overall dimensions	204 x 120 x 98 mm (LxWxH)

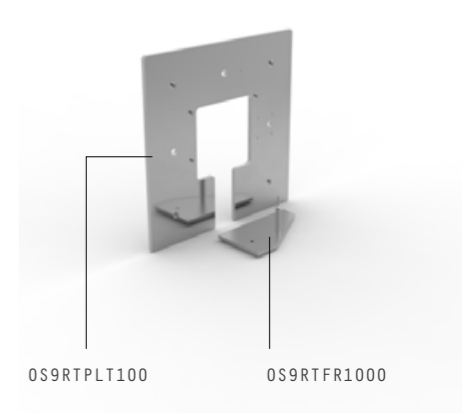

OS9RTPLT100

OS9RTFR1000

READOUTS, DATALOGGERS & ACCESSORIES



MIND READOUT

MIND is an innovative readout, compatible with both digital and analogue instruments. It is designed in order to be rugged, flexible and to obtain fast and precise readings. Internal diagnostic sensors (temperature, humidity and battery voltage) help the user to control the health of the readout during the usage.

OMIND000000 MIND READOUT

Type of measurements	mA, mV, mV/V, V, °C, VW, RS-485 Modbus RTU
A/D conversion	Resolution: 24bit, modulation method sigma-delta
Material	aluminum
IP class	IP65
Overall dimensions	205x128x45 mm
Weight	1 Kg
Operative temperature	-30 to +70 °C (battery -20 to +60°C)

Detailed electrical characteristics available on MIND datasheet

SPARE PARTS AND ACCESSORIES

0ECAV08V2J0	Jumper cable with 2 connectors for reading connectorized instruments
0ECAV08V2S0	Switch jumper cable with 2 connectors for switch panels and measuring boxes
0ECAV8P6A00	6-clips jumper cable with 6 alligator clips for instrument reading
0ECABMIND00	Battery charger Input volt. 90-264 Vac, 50-60 Hz IP41 Max output power 10 W
0ECABMINDMU	MUX box to MIND cable Jumper cable for direct connection from MIND to multiplexer boxes.



MIND APP MAIN FEATURES

- Automatic configuration of sensors through QRcode
- Simultaneous display of electrical and engineering measures
- Real time charts
- Quick read for immediate readings without configuration
- Geolocation of sites and sensors
- Multiplexers reading
- Digital chains reading
- Biaxial analogue sensors reading with the simultaneous reading of temperature
- Search engine for sites and sensors
- Spectrum Analyzer on board for vibrating wire sensors analysis



MIND App compatible with:



MINIOMNIALOG DATALOGGER

MiniOMNIALog is a 4 channels, battery powered logger designed for field use with a low power consumption. It permits to read and store data from both analogue (VW, mA, V, etc...) and digital instruments. Stored readings can be retrieved via USB connection with a PC or with a USB flash drive if a PC is not available.

OOMNIAMINIO MINI OMNIALOG

Processor	ARM Cortex - M3, 20 MHz CPU
A/D converter	24 bit with autocalibration
Type of measurement	mA, mV, mV/V, V, °C (NTC), Hz (VW)
Mass storage	2 GB for data and WEB pages
Resolution	1 µA at FS 20 mA 1 µV at FS ±10 mV 0.001mV/V at FS ±10 mV/V 0.1 Hz at FS 400-6000 Hz 0.1 °C for NTC
Accuracy	±0.05% FS (0.1% FS for NTC)
Analog differential inputs	4 channels, configured at factory
Digital input	RS485 digital sensors
Digital output	one relay for alarm, 30V, 1A
Temperature drift	<10 ppm/°C (-30°C +70°C)
Internal battery	6 x 1.5V AA not rechargeable
Environmental	-30°C +70°C, IP67
COMM port	USB 2.0
Dimensions and weight	151 x 125 x 90 mm, 780 g

ACCESSORIES

00MX24V030W	Digital sensor kit to allow miniOMNIALog to manage up to 64 digital instruments.
0AXBC022010	90/230 V power supply kit consisting of a 10W 12V AC/DC converter and a plastic box housing the 2.3 Ah battery.
0AX10W003AH	Solar power kit composed by a 10W solar panel with 10 m cable and a plastic box housing the 2.3 Ah battery and charge controller.



Project:
Tempa Rossa Oil Project
Basilicata - Italy

SISGEO.COM



OMNIALOG DATALOGGER

OMNIALog is a web-based datalogger designed for geotechnical and structural monitoring applications. OMNIALog offers extensive measurements and control functionality; it is supported by a selection of communication options. On-board keyboard/display and external storage using USB flash drive are also included. OMNIALog doesn't require any proprietary software and stored data can be sent to the user FTP server or email address.

OOMNIALOG00 AND OOMNIALOG24 MODULES

Processor	ARM Cortex M3, 120 MHz, 1MB RAM
A/D converter	24 bit with autocalibration
Memory	2 GB SD card for data and web pages
Analog inputs	N.8 diff. (OOMNIALOG00) N.24 diff. (OOMNIALOG24) expandable by multiplexer (MUX) up to 384 channels
Digital inputs	N.2 opto-isolated
Resolution	1 μ A at FS 20 mA 1 μ V at FS \pm 10 mV 0.001 mV/V at FS 10 mV/V 0.1 Hz at FS 6000 Hz 0.1 $^{\circ}$ C for PT100 and NTC
Measurement accuracy	\pm 0.01% FS (0.1% FS for NTC and PT100)
Temperature drift	< 10 ppm/ $^{\circ}$ C over all temp. range
Comm. ports	LAN 10/100, USB 2.0, RS232
Protections	electro-mechanical relays on every channel and gas discharge tubes on circuit
External battery	12V DC nominal
Operating temp. range	-30 $^{\circ}$ C +70 $^{\circ}$ C (display -20 $^{\circ}$ C +70 $^{\circ}$ C)

OOMNIALOG00 DIGITAL MODULE

Processor	ARM Cortex M3, 120 MHz, 1MB RAM
A/D converter	24 bit with autocalibration
Memory	2GB SD card for data and web pages
Digital inputs	N.1 opto-isolated
Comm. ports	LAN 10/100, USB 2.0, RS232
Protections	electro-mechanical relays
External battery	12V DC nominal
Operating temp. range	-30 $^{\circ}$ C +70 $^{\circ}$ C (display -20 $^{\circ}$ C +70 $^{\circ}$ C)



OMNIALOG CABINETS

The versatility and the flexibility of OMNIALog allow customized systems to meet the Client needs and the project requirements. A variety of "cabinet" with internal relay multiplexers are offered in order to expand the number of channels (sensors) managed by one datalogger. Each channel can be independently configured minimizing the number of multiplexer.

COMPONENTS AND ACCESSORIES

00MNCAB2000	IP65 cabinet, polycarbonate, 500x400x200mm, ready for max No.2 MUX digital power supply kit and comm interface
00MNCAB3000	IP65 cabinet, stainless steel, 600x400x250mm, ready for max No.3 MUX, digital power supply kit and comm interface
00MNCAB8000	IP65 cabinet, stainless steel, 600x600x250mm, ready for max No.8 MUX, digital power supply kit and comm interface
00MN24MUX00	MUX board, 24 channels, overvoltage protections on every channel
00MN24V100W	Additional kit for digital instruments including DC/DC 12/24V 100W power supply and No.4 input wiring board

MAIN COMMUNICATION INTERFACES

00MXR0UTVPN	HSPA 3G router with VPN service Is the fastest and easy way for remote OMNIALog managing and data download.
00MXF0MMSWT	Optical fiber interface (available only on request) Switch ethernet with multimode optical fiber ports for in/out (Available only on request).



REMOTE MULTIPLEXERS

Multiplexer boxes offer a valid alternative to OMNIALog cabinets when a distributed sensor network is preferred. The relay multiplexer boards, mounted inside an IP67 box, operate as peripheral units; they are connected through a RS485 bus to a remote OMNIALog datalogger. Remote multiplexers can be used as terminal boxes, reading them with MIND readout.

COMPONENTS AND ACCESSORIES

00MNIABOX00	IP65 box, OOMNIALOG00 module polycarbonate enclosure, 400x300x180mm ready for external MUX box connection and communication interface
00MN24MUXB0	MUX box, 24 channels inputs polycarbonate enclosure, 300x300x180mm overvoltage protections on every channel
00MN48MUXB0	MUX box, 48 channels inputs polycarbonate, 300x300x180mm overvoltage protections on every channel
0WE610MUXZH	Connecting cable from MUX to MUX or from MUX to OMNIALog datalogger
00MX4MUXEXT	External MUX connection board for maximum No.4 external MUX.
0AXB0C22000	IP67 power supply kit AC/DC charger, Vin 85-265 Vac 50-60Hz, Vout 13.2V / 0.9A.
0AX00W000AH	Solar power supply package available in different model, including panel, battery and charge controller.

WMS WEB MONITORING SYSTEM

WMS is a software platform for the management and visualization of data coming from monitoring systems. Through its WEB pages the data are available for the Users at any time, in graphical and tabular format. It is possible to set up to 4 types of alarm thresholds and send alarm messages via SMS/e-mail to authorized Users when an instrument reading exceeds the thresholds.

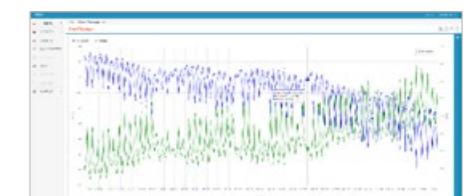

Project:
San Leo Rockfall
Italy

READOUTS, DATALOGGERS & ACCESSORIES



WR LOG WIRELESS MONITORING SYSTEM

WR LOG system is composed by a number of nodes to which instruments are connected, and a gateway communicating with nodes through radio. Nodes are configured through an Android APP while the gateway have a web server on-board for the set-up. Distance between node and gateway can arrive up to 15 km. The gateway can push data on a FTP server; remote connection to gateway is allowed for data download and set-up.

GATEWAYS

The gateway receive readings from the nodes and push data through the internet to a server for management and visualization.

OLSWR868GW4	868 MHz ISM BAND GATEWAY 10/100 Ethernet, 4G modem
OLSWR915GW4	915 MHz FCC ISM BAND GATEWAY 10/100 Ethernet, 4G modem
OLSWR923GW4	915-928 MHz ISM BAND GATEWAY 10/100 Ethernet, 4G modem

NODES

OLSWR1CHVMS	1 CH VIBRATING WIRE NODE Enclosure 100 x 100 x 61 mm, IP67
OLSWR5CHVW0	5 CH VIBRATING WIRE NODE Enclosure 100 x 200 x 61 mm, IP67
OLSWR4CHANL	4 CH ANALOGUE NODE Enclosure 100 x 200 x 61 mm, IP67
OLSWRDIG000	DIGITAL NODE Enclosure 100 x 200 x 61 mm, IP67
OLSWR02INC15	WIRELESS TILT METER Enclosure 100 x 100 x 61 mm, IP67

SOFTWARE SUITE



READOUT ACCESSORIES AND SPARE PARTS

In order to simplify installation and reading procedures, Sisgeo offers a variety of accessories to meet all the Client requirements such as cable splicing kits, connectors, cable end protections, etc... Cable splicing kits permit to make cable joints at site by means of bi-component epoxy resin.

ACCESSORIES

0EGSM0K0200	CABLE SPLICING KIT (2 TUBES) with caps and epoxy resin
0EGSM0K1000	CABLE SPLICING KIT (10 TUBES) with caps and epoxy resin
1000RES2COR	BI-COMPONENT EPOXY RESIN 0,5 Kg pack
0ECON07MV00	FLYING MIL CONNECTOR AND CAP 7 PIN male MIL connector
0ETPOP60700	CABLE END PROTECTION for cable with OD 2.3 to 6.7 mm
0ETPOP60900	CABLE END PROTECTION for cable with OD 4.8 to 8.0 mm
0ETPOP61300	CABLE END PROTECTION for cable with OD 7.0 to 12.0 mm
0EPD0000000	SIMPLE JUNCTION BOXES Available up to 1, 2 or 3 signal cables
0EPD023IPID0	DIGITAL JUNCTION BOXES Joint 2 cable in one line
0EPDP000W00	JUNCTION BOXES WITH OVP Over voltage protection up to 6 wires
0EPC0600S00	TERMINAL SWITCH BOXES up to 6, 12, 18 or 24 instruments

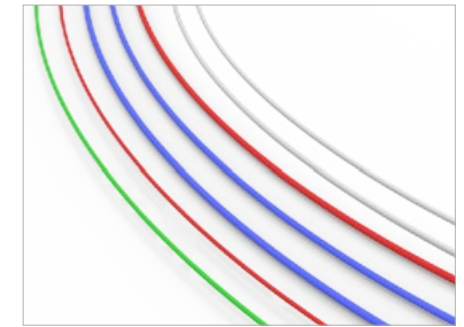

SIGNAL AND MULTICORE CABLES

Sisgeo cables are designed for a variety of geotechnical and hydro-geological applications and can be embedded in concrete or buried in the soil. All Sisgeo signal and multicore cables have LSZH (Low Smoke Zero Halogen) jackets according to the latest required standards.

INSTRUMENT CABLES

OWE102KE0ZH	2-LEADS 20-AWG CABLE, KEVLAR Polyolefin + M1 technopolymer jackets
OWE104K00ZH	2-TWISTED PAIRS 22-AWG CABLE Polyolefin + M1 technopolymer jackets
OWE104SG0ZH	2-TWISTED PAIRS 22-AWG CABLE M1 technopolymer red jacket
OWE104X20ZH	ELECTRIC ARMoured CABLE Polyolefin + M1 technopolymer jackets
OWE1060LSZH	ELECTRIC CABLE 6 COND. Polyolefin + M1 technopolymer jackets
OWE106IPOZH	ELECTRIC CABLE 6 COND. Polyurethane external jacket
OWE110DX0ZH	ELECTRIC CABLE 10 COND-24 Polyolefin + M1 technopolymer jackets
OWE606IPDZH	EL. CABLE 6 COND FOR DIGITAL IPI Polyurethane external jacket

VENTED CABLE

OWE203KE0ZH	2-LEADS VENTED CABLE, KEVLAR Polyolefin + M1 technopolymer jackets
-------------	--

MULTICORE CABLES

OWE1160LSZH	8-TWISTED PAIRS 24-AWG CABLE Polyolefin + M1 technopolymer jackets
OWE1320LSZH	16-TWISTED PAIRS 24-AWG CABLE Polyolefin + M1 technopolymer jackets

OMNIALOG-MUX CONNECTING CABLE

OWE610MUXZH	OMNIA-MUX CONNECTING CABLE 4+2 twisted pairs, M1 technopol. jacket
-------------	--



Project:
Karahnjukar HPP
Iceland



MONITORING SOLUTIONS FOR RAILWAY INFRASTRUCTURES



SISGEO RAIL®

The railway sector deserves the most advanced surveillance solutions to guarantee the highest level of safety. SISGEO RAIL® is the specialized brand of the SISGEO Group dedicated to the railway industry and rail monitoring solutions. The mission is to actively participate in the digitization of worldwide rail infrastructure providing unique value through both cabled and IoT monitoring solutions. Thanks to the recognized experience of SISGEO in the field of structural and geotechnical instrumentation, through large investments in innovation and R&D, SISGEO RAIL® is able to meet the industrial and technological challenges linked to the development of this strategic and environmentally friendly transportation mode that is the train.



Discover more at: www.sisrail.com

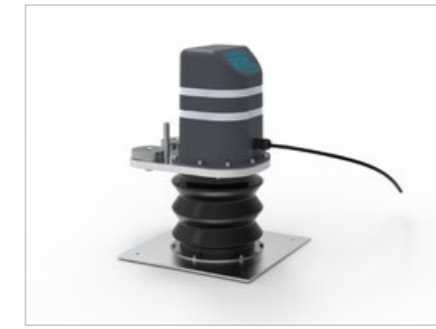

FLX-RAIL® RAIL SWING MONITORING

FLX-Rail®, specially developed for the railway swing monitoring, automatically and continuously measures the maximum vertical deformation of the rail at each train passage. This phenomenon is commonly known as "rail swing" or "rail dance". The instrument is installed between the track and the ballast, fixed under the rail using two powerful magnets for a quick and easy installation.

SBV® TECHNOLOGY

SBV® is a revolutionary technology specially developed for railway monitoring instrumentation which aims to activate the measuring devices only when needed.

TECHNICAL SPECIFICATIONS

0DFLXS7000T	FLX-Rail® gauge, vertical displacement range 70 mm with rail skin temperature sensor
0DFLXS7010T	FLX-Rail® gauge, vertical displacement range 70 mm with rail biaxial tiltmeter and rail skin temp. sensor

DYNAMIC DEFLECTION SENSOR

Sensor type	Optic
FS and Measuring range	70 mm
Sensor resolution	0.01 mm
Reading frequency	350 Hz
Offset temperature dependency	0.03 mm/°C
Sensor repeatability	±0.01 mm
Sensor 24 hours stability ⁽¹⁾	±0.1 mm
Sensitivity ⁽²⁾	See Calibration Report
Sensor accuracy (Lin. MPE) ⁽³⁾	<±0.1 mm

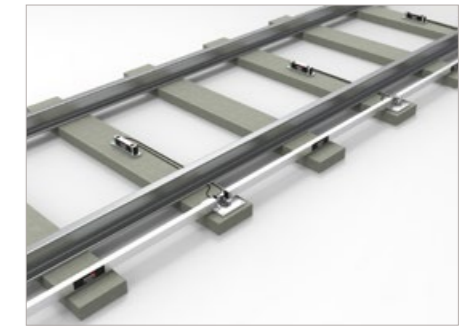

RDS RAILWAY DEFORMATION SYSTEM

RDS, Railway Deformation System, is a unique monitoring system designed by Sisgeo for the automatical surveying of the rail tracks longitudinal deformation and the sleepers rotation. The rail track geometry is monitored in terms of longitudinal level and torsion of the track. RDS can be managed by a single operator on the web with WMS* (Web Monitoring System).

ADDITIONAL INFORMATIONS

Compared to the traditional systems, including topographic surveys, RDS offers to the Customers either high performances and significant reduction of the operating costs. In fact when the system is correctly installed there is no field activity required by technicians at site. RDS components, connected through digital cable to OMNIAlog with router, will be read automatically by WMS* (Web Monitoring System). FieldStat* software running directly on WMS platform, allows to determine the correlations that may have influence on collected data, for example temperature, and to filter the measures from the effects of external factors. With WMS it will be possible to have alarm thresholds and alerting.

(* Trademarks of Field Srl)



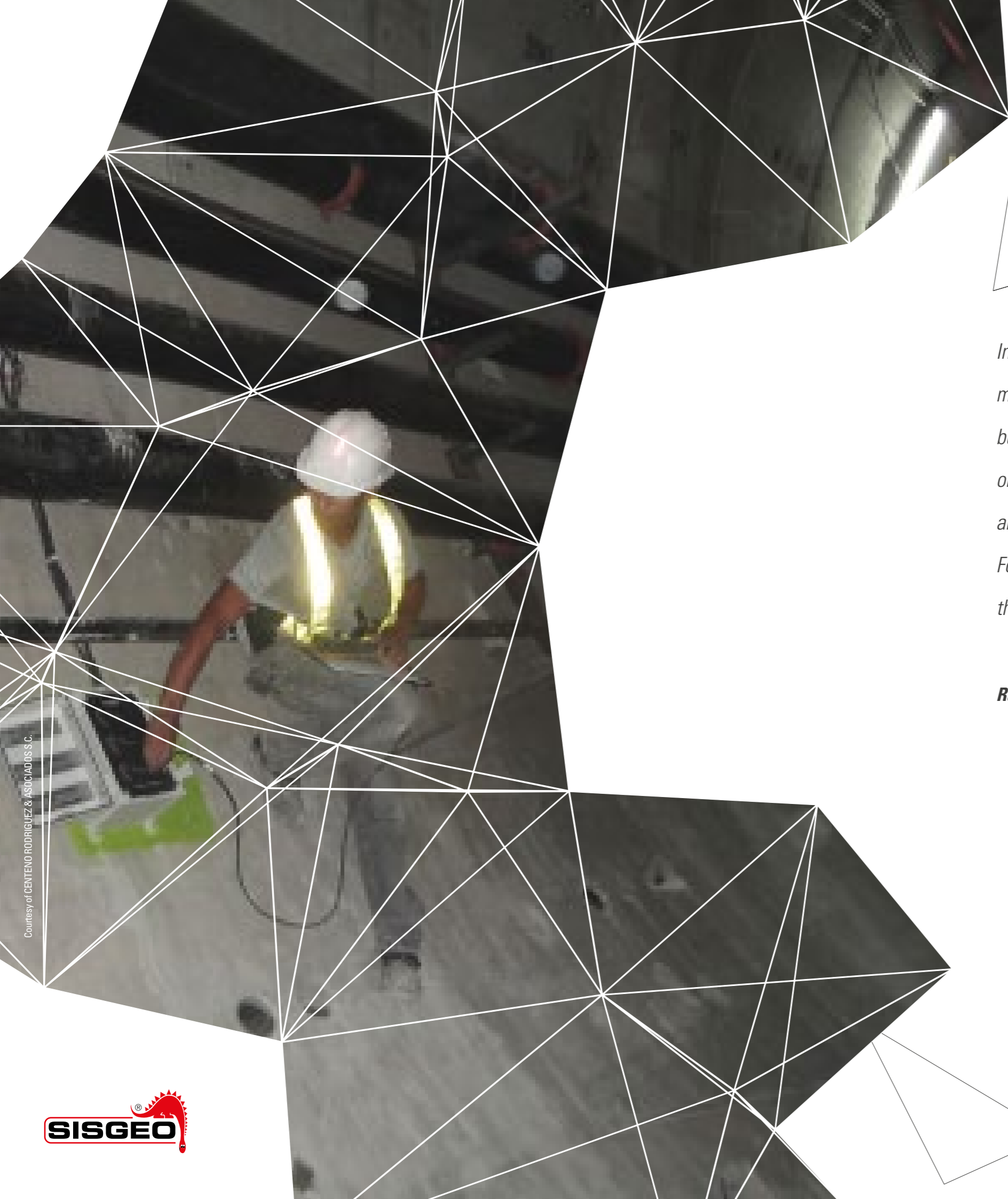

In construction underground, where the engineer deals with materials having properties that vary not only in space but also in time, details of construction often have significant or even overwhelming influence on the behavior of the structure and of the surrounding soil.

For an understanding of the behavior, these details must be observed and recorded.

Ralph B. Peck (1972)

Courtesy of CENTENO RODRIGUEZ & ASOCIADOS S.C.





SISGEO S.R.L.
VIA F. SERPERO 4/F1
20060 MASATE (MI) ITALY
PHONE +39 02 95764130
FAX +39 02 95762011
INFO@SISGEO.COM

WWW.SISGEO.COM