



**THE FIRST
MONITORING
CHANNEL**



DAMS SAFETY
AND MONITORING



Al Wehda Dam, Jordan

— WHY DAM MONITORING?

The most common causes of failure of operating dams are:

- *poor construction materials*
- *geological instability*
- *landslide into reservoir*
- *poor maintenance*
- *human, computer or design error*
- *internal erosion (earth-fill dams)*
- *earthquakes*



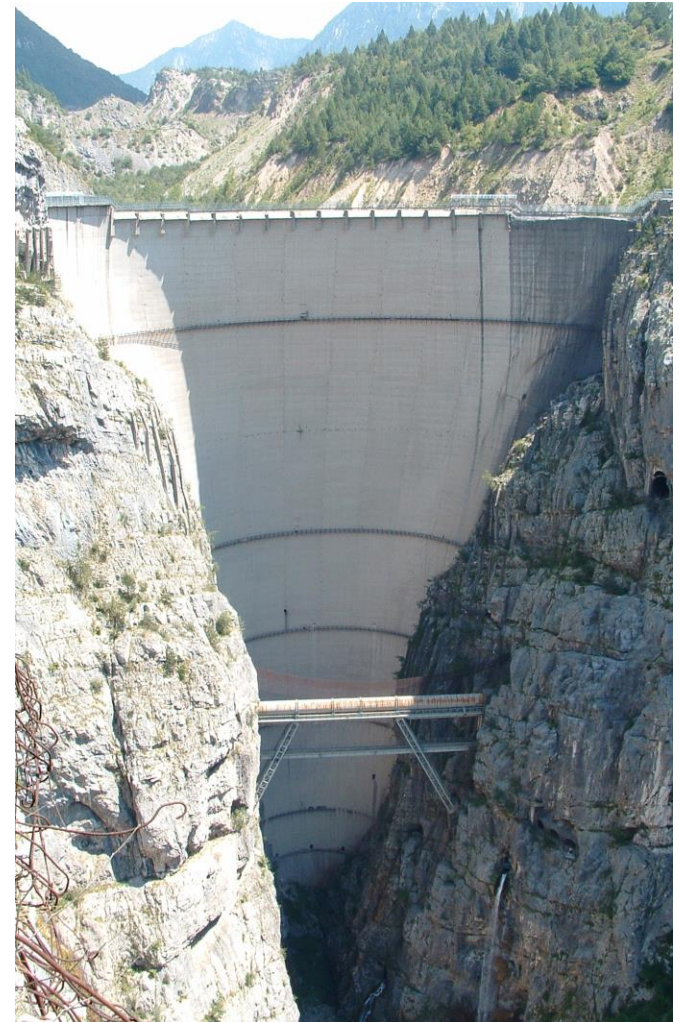





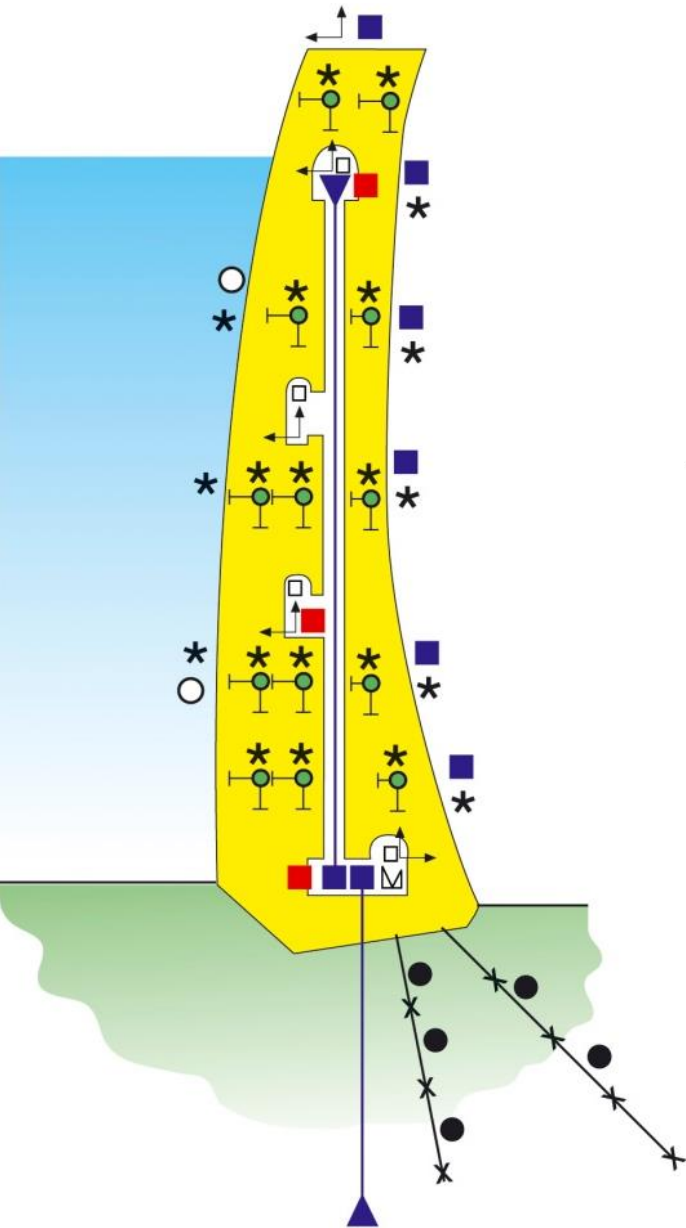



→ **Inadequate monitoring system**



Vajont Dam, Italy

ARCH AND GRAVITY DAMS





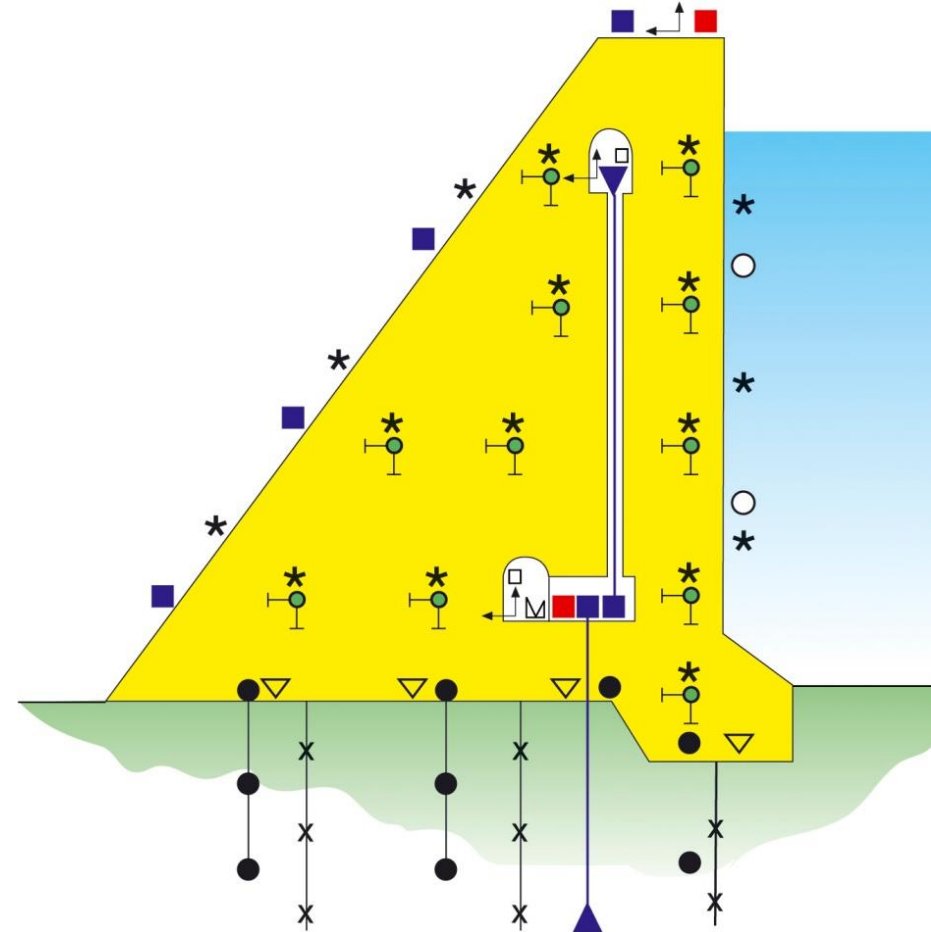



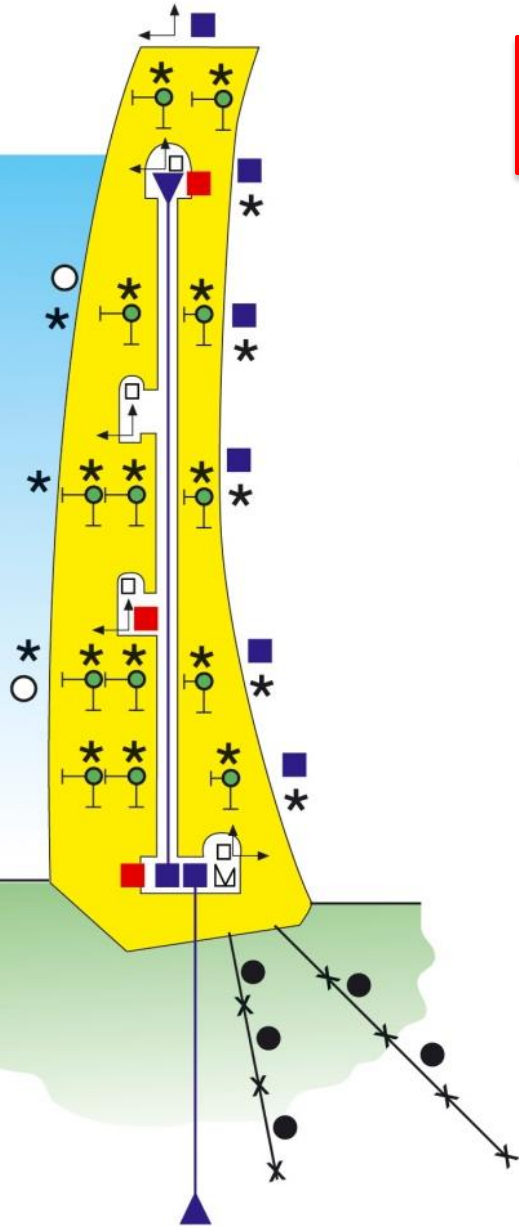





-  Direct pendulum
-  Inverted pendulum
-  Embedded strain-gauge
-  Thermometer
-  Weir (flow meter)
-  Tiltmeter (clinometer)
-  Joint meter
-  Borehole extensometer
-  Piezometer
-  Earth pressure cell
-  Water level meter
-  Survey point
-  Strong motion accelerograph



__ PENDULUMS AND READOUTS



-  Direct pendulum
-  Inverted pendulum

-  Embedded strain-gauge
-  Thermometer
-  Weir (flow meter)
-  Tiltmeter (clinometer)
-  Joint meter
-  Borehole extensometer
-  Piezometer
-  Earth pressure cell
-  Water level meter
-  Survey point
-  Strong motion accelerograph

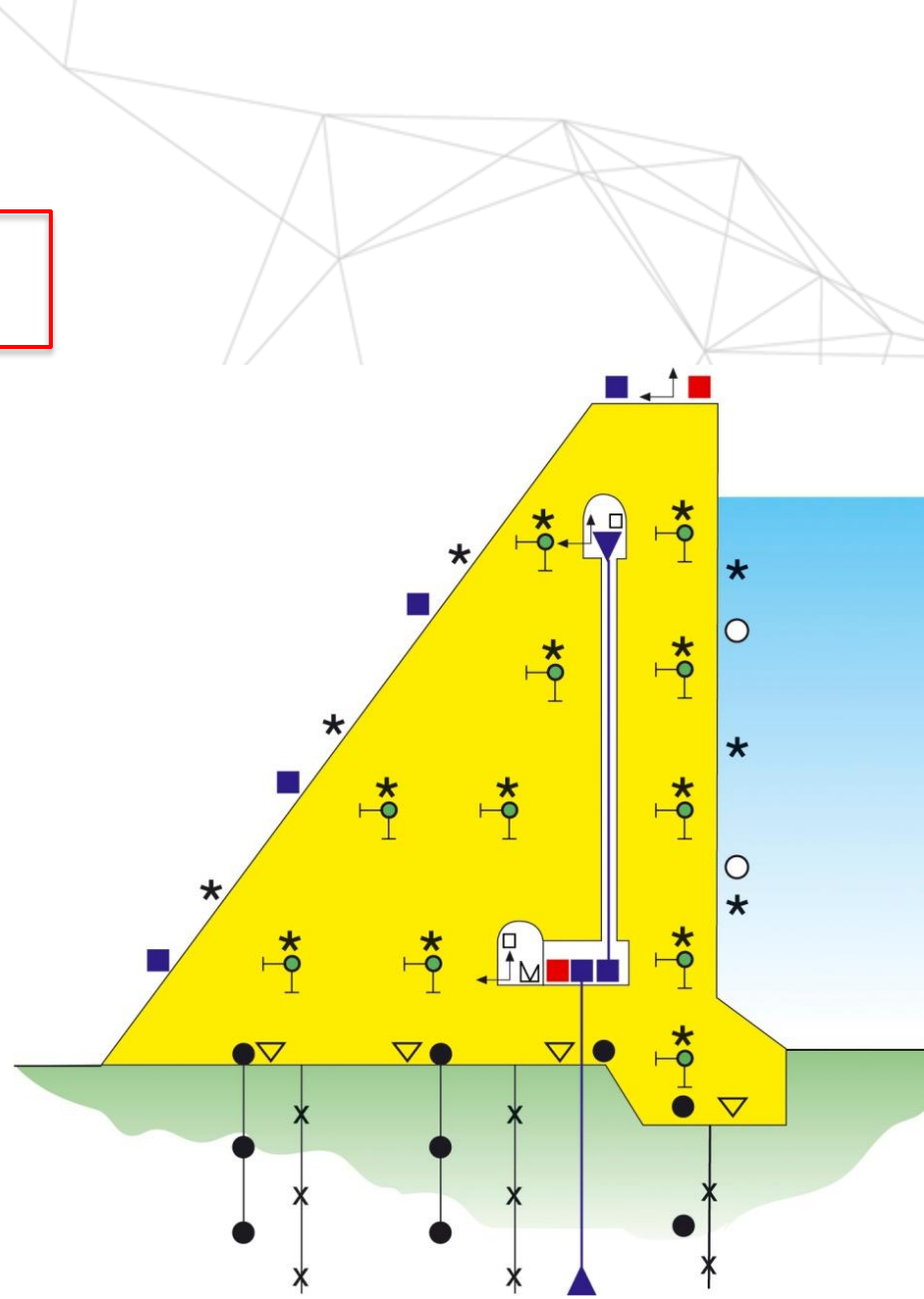

— PENDULUMS AND READOUTS

Direct pendulum

Inverted pendulum

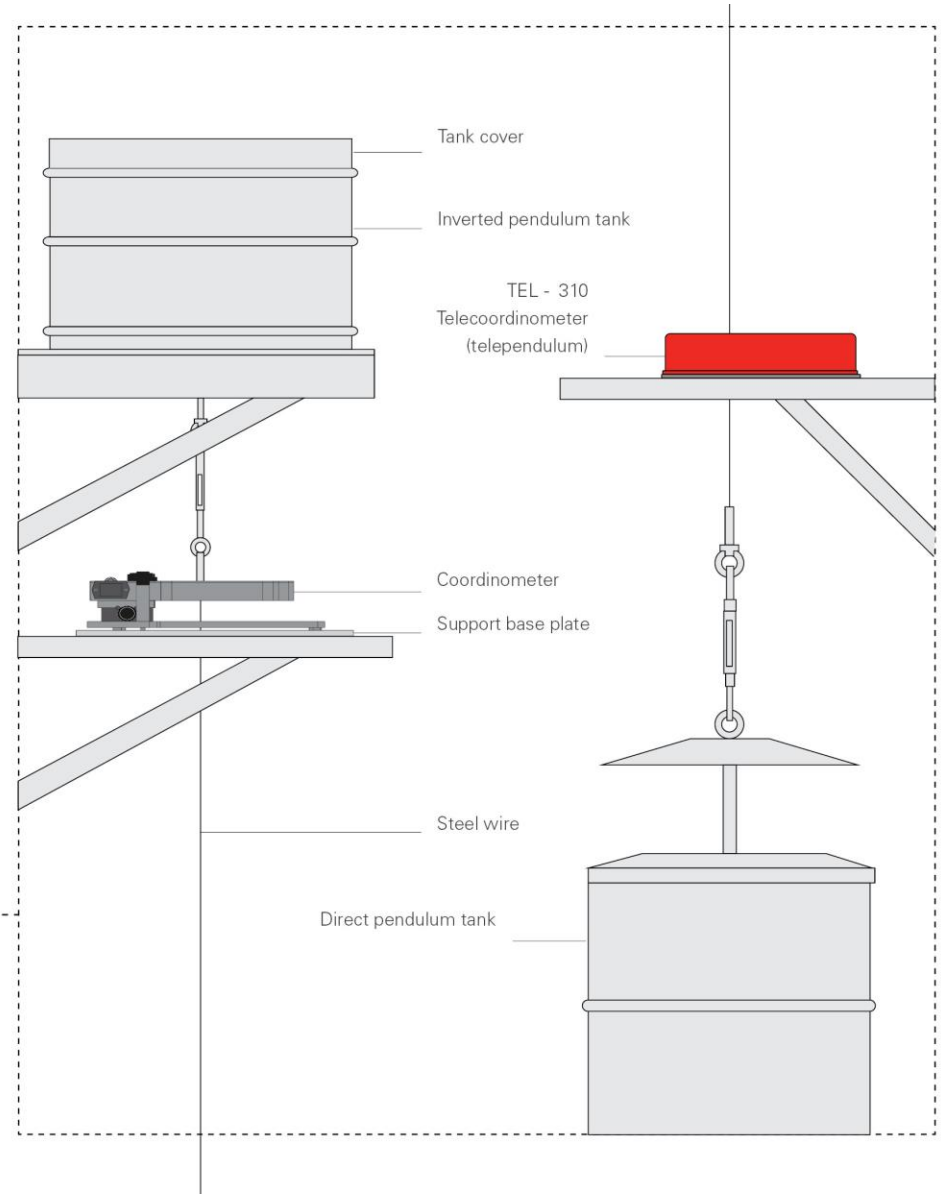
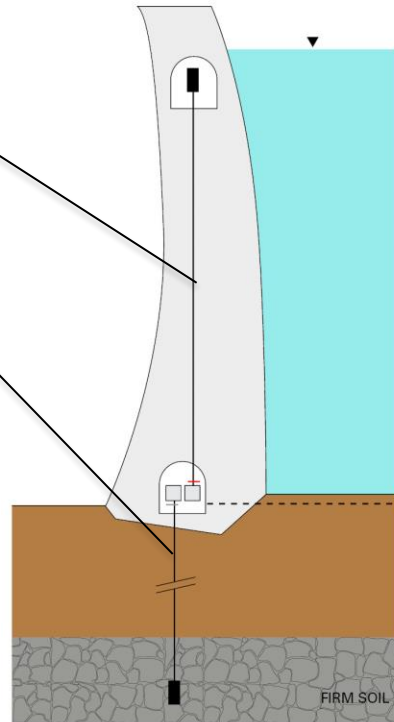

__ TEL-310 TELECOORDINOMETER (TELEPENDULUM)

- *Wide measuring range: 60x145mm;*
- *Waterproof components IP68 until 50kPa (5m water head);*
- *Remote auto-diagnostic through "log file";*
- *High level built-in software for data elaboration and validation.*

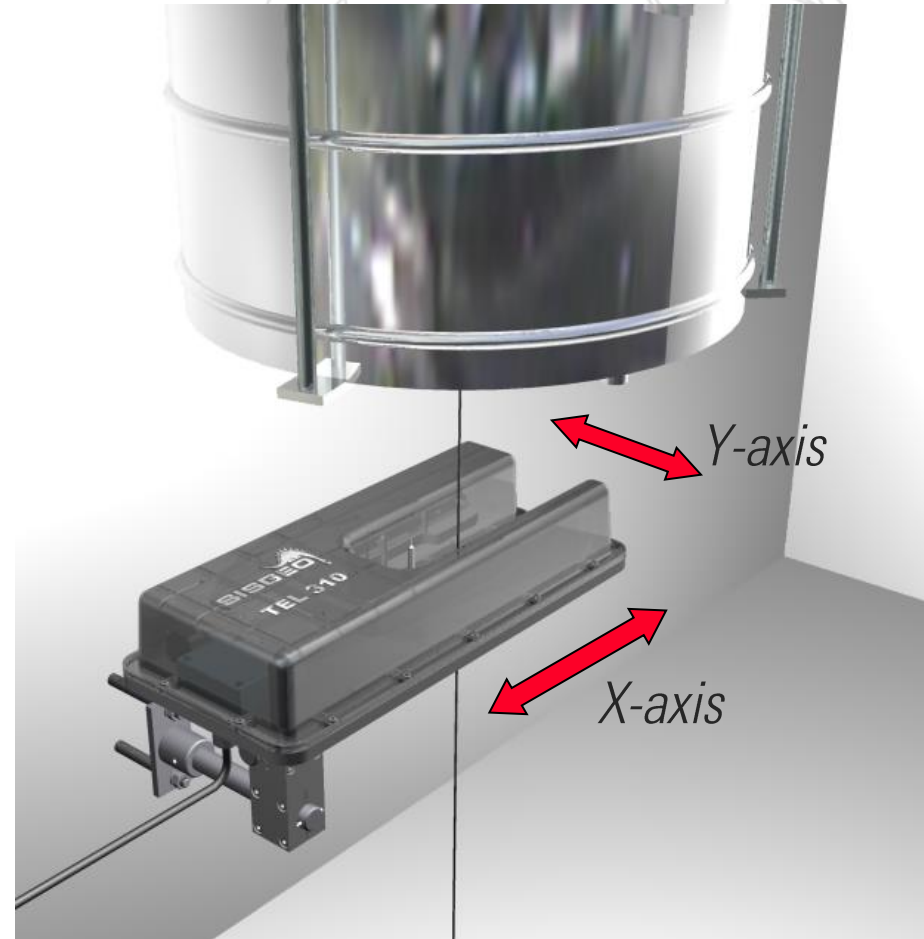





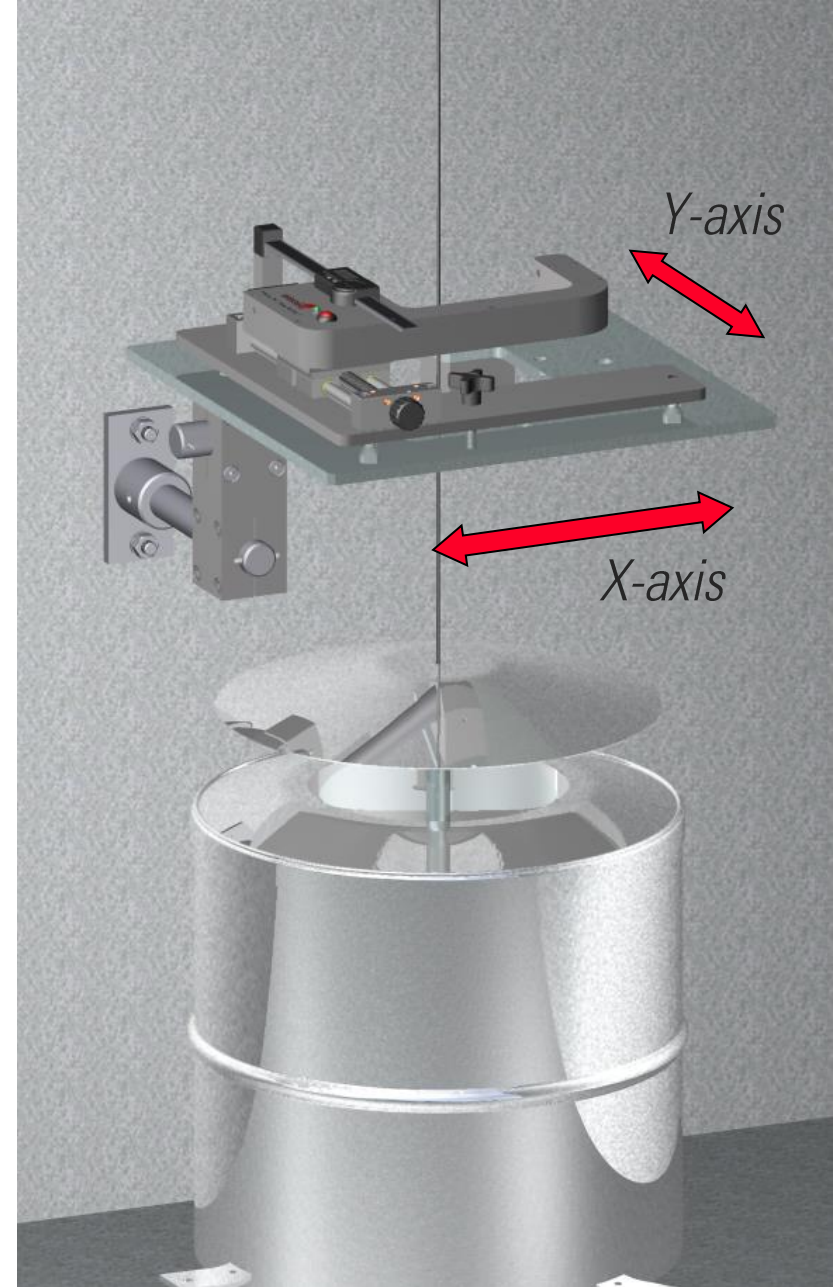



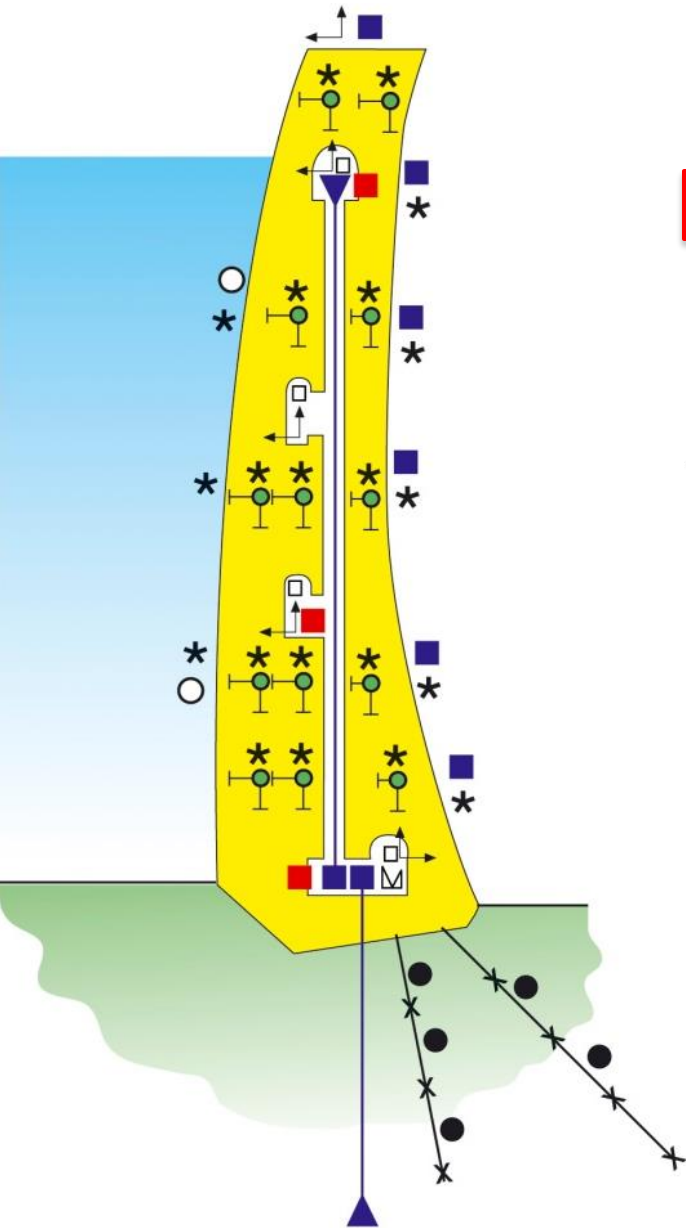





— MANUAL COORDINOMETER

- *Simple to use*
- *Removable in order to take readings in different location*
- *Suitable to substitute TEL310 telecoordinometer under service*



VIBRATING WIRE STRAIN GAUGES



-  Direct pendulum
-  Inverted pendulum
-  Embedded strain-gauge
-  Thermometer
-  Weir (flow meter)
-  Tiltmeter (clinometer)
-  Joint meter
-  Borehole extensometer
-  Piezometer
-  Earth pressure cell
-  Water level meter
-  Survey point
-  Strong motion accelerograph

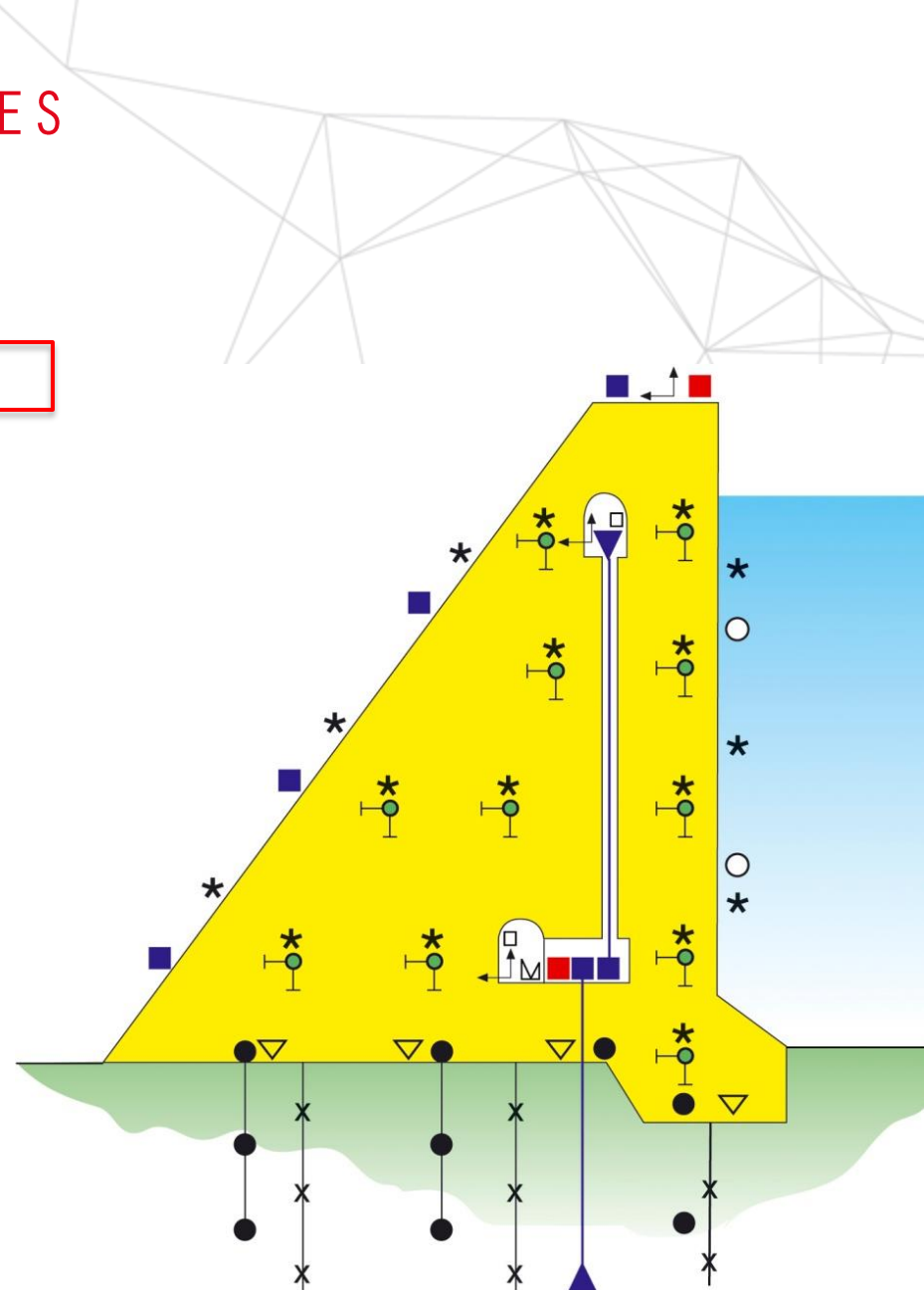

VIBRATING WIRE STRAIN GAUGES

Stress monitoring into concrete structures or on metal supports.

- *Arc-weldable model*
- *Embedment model*
- *3-D mounting available*

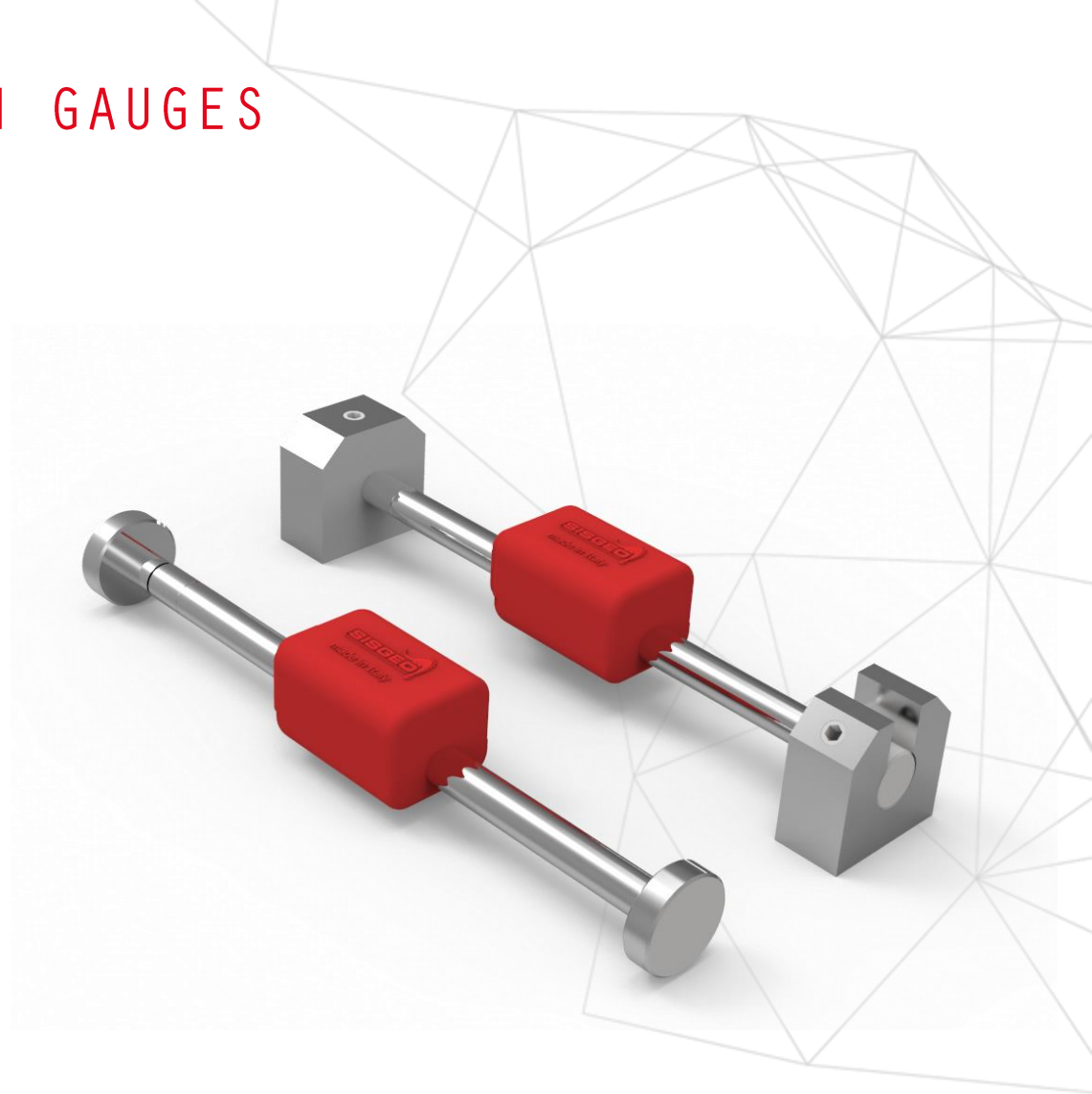

__ EMBEDMENT VIBRATING WIRE STRAIN GAUGES



__ ARC-WELDABLE VIBRATING WIRE STRAIN GAUGES





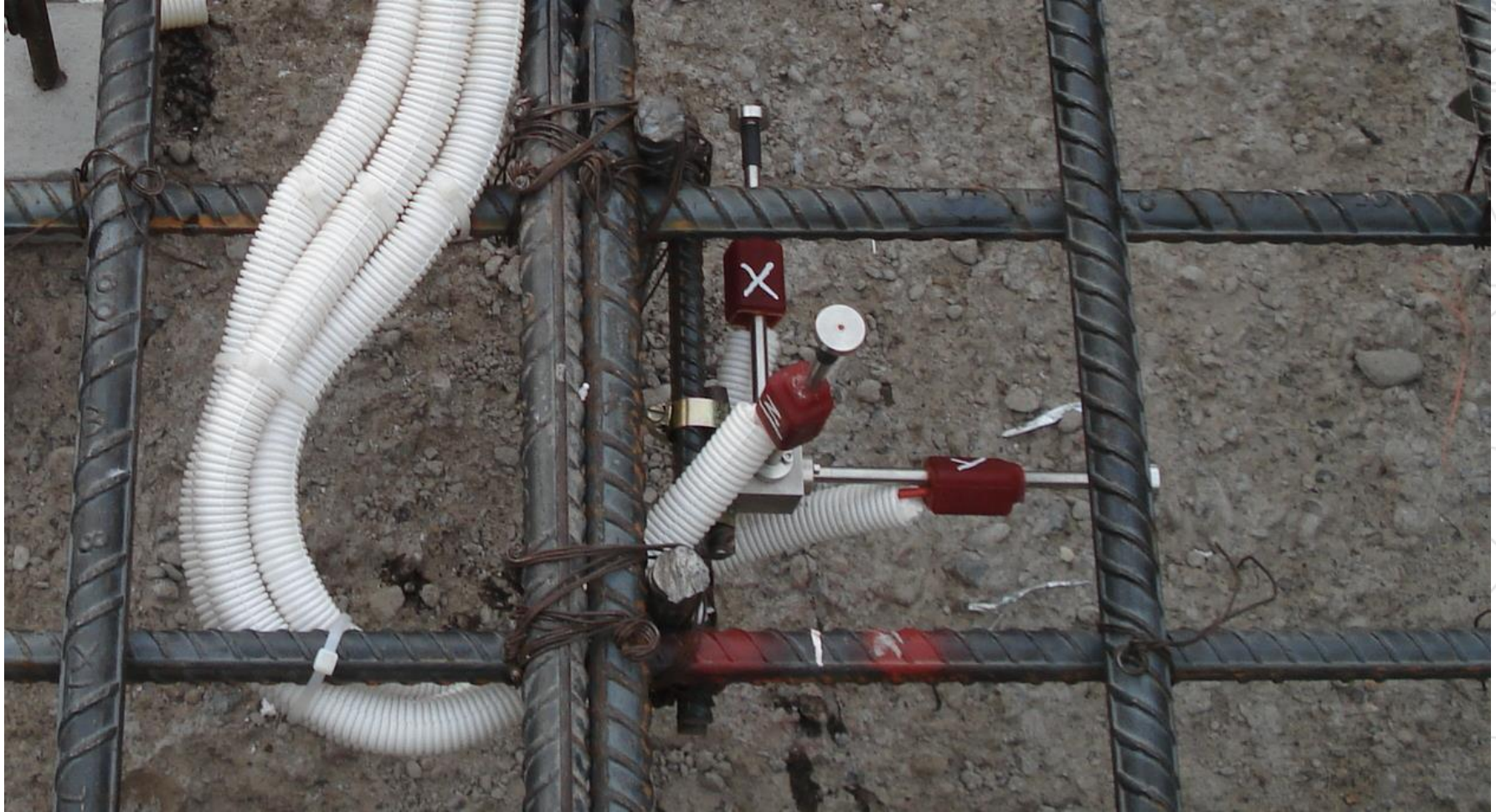



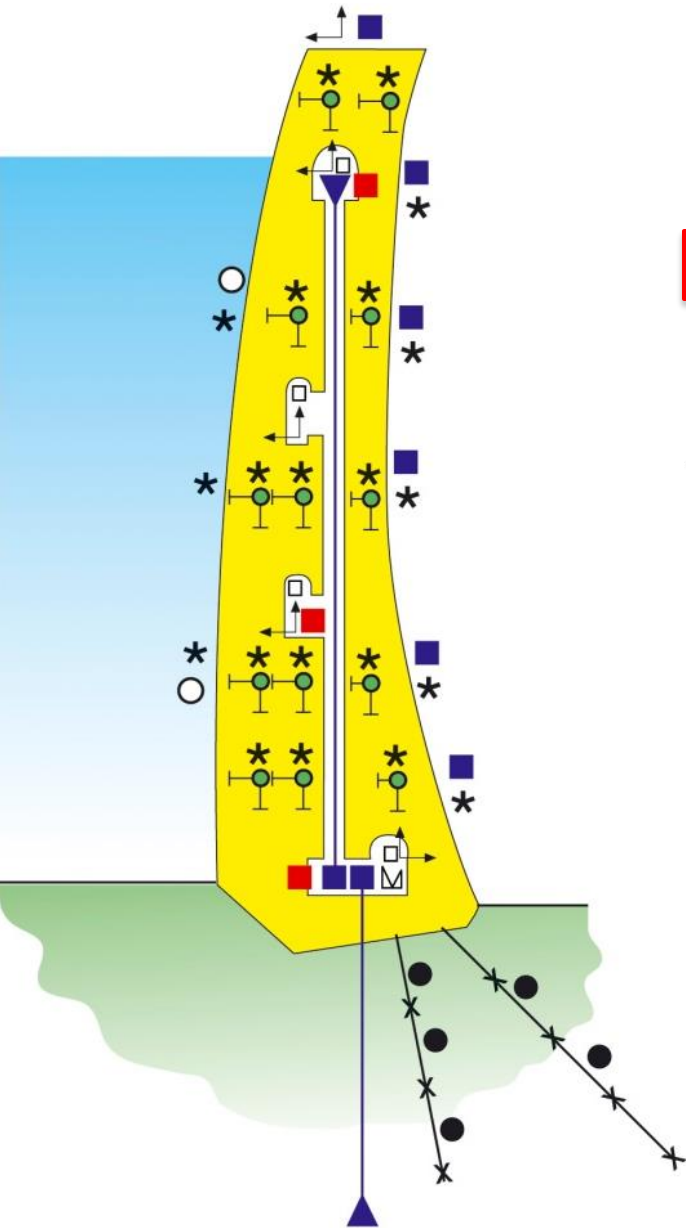





__ 3-D ROSETTE MOUNTING STRAIN GAUGES



TEMPERATURE GAUGES



-  Direct pendulum
-  Inverted pendulum
-  Embedded strain-gauge
-  Thermometer**
-  Weir (flow meter)
-  Tiltmeter (clinometer)
-  Joint meter
-  Borehole extensometer
-  Piezometer
-  Earth pressure cell
-  Water level meter
-  Survey point
-  Strong motion accelerograph

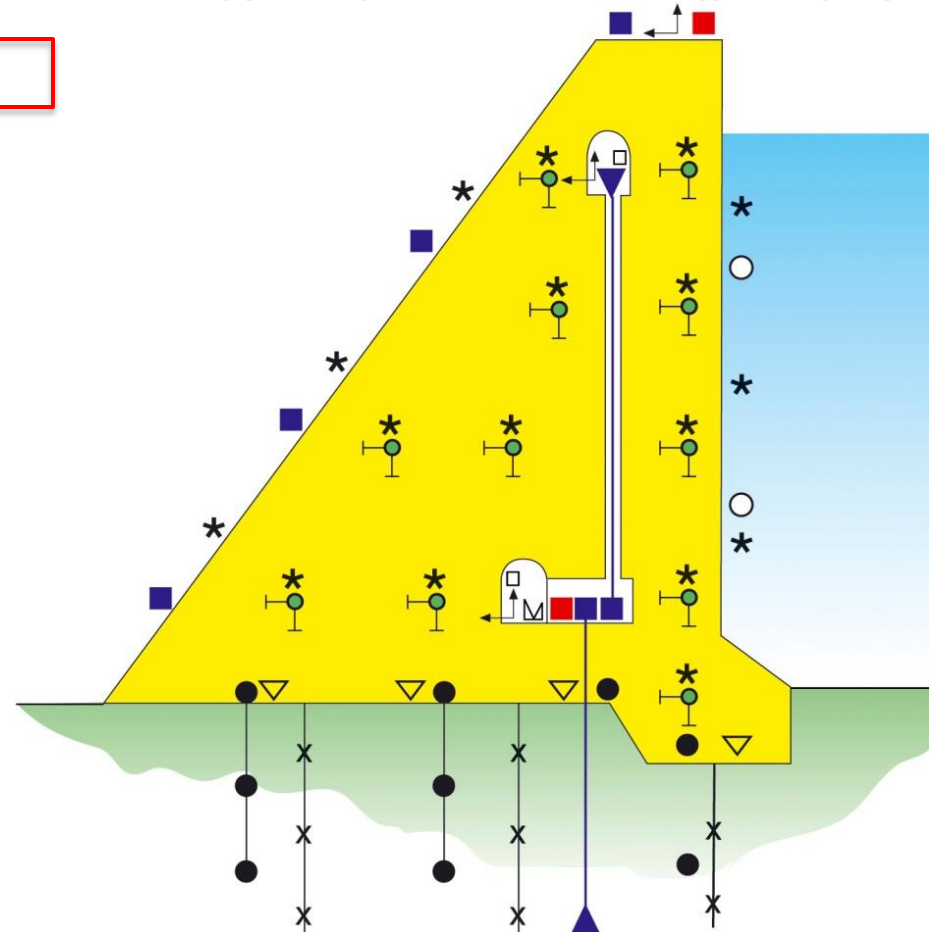

— TEMPERATURE GAUGES

- *Concrete curing*
- *evaluating the influence of thermal effects on the measurements and on the structure which is monitored*
- *Monitor the water temperature inside boreholes, wells, basin, etc...*

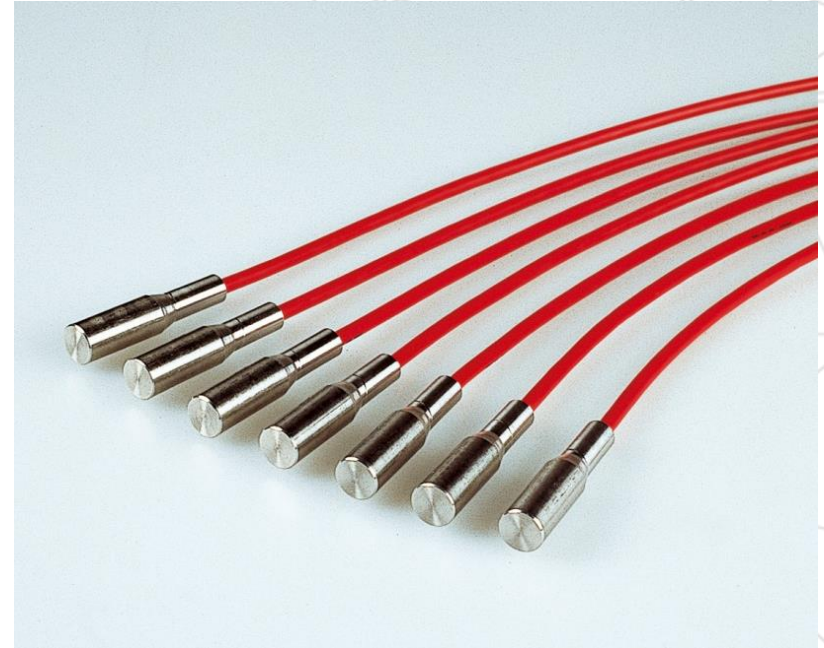

All models are housed in a shock resistant stainless steel body to be embedded in concrete.

— TEMPERATURE GAUGES



TEMPERATURE GAUGES

Most Sisgeo's instruments have a built-in temperature sensor (thermistor)

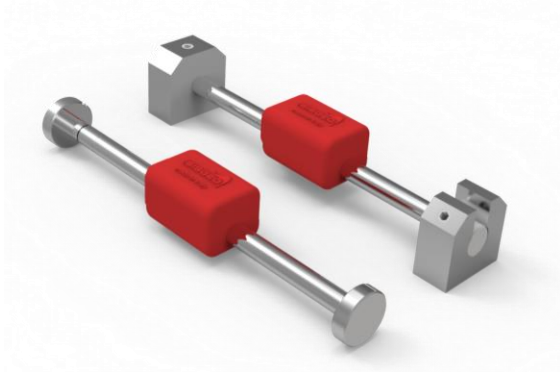

VW STRAIN GAUGES

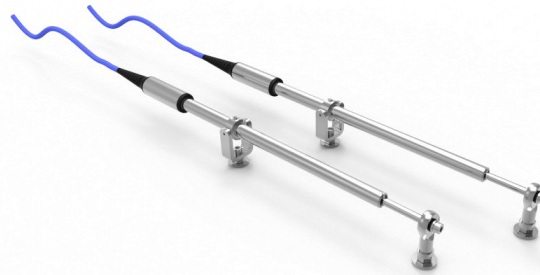

VW CRACK METERS



MEMS IPIS



H-LEVEL SETTLEMENT GAUGES

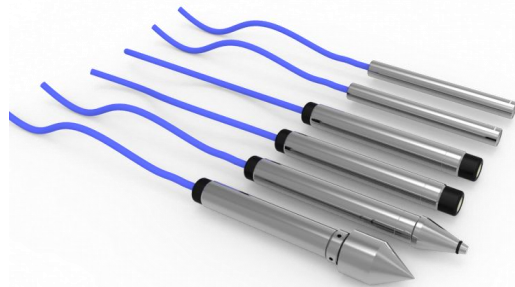









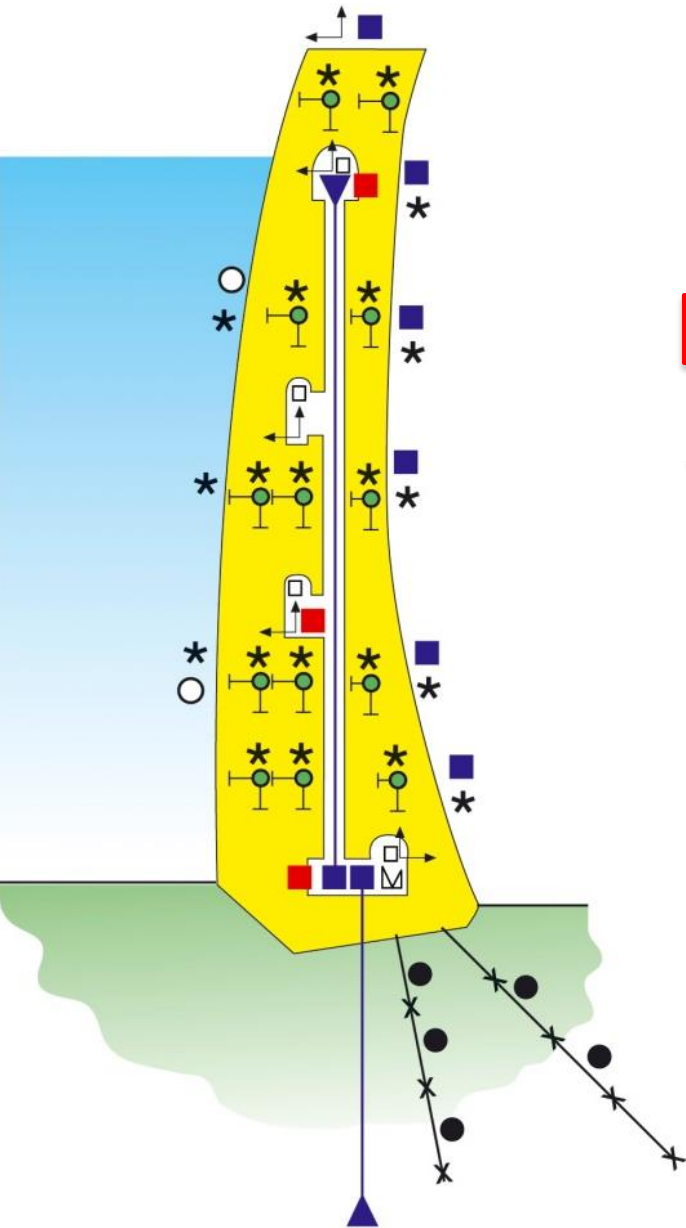



VW PIEZOMETERS



MEMS TILT METERS

WEIR (FLOW) METERS - V-NOTCHES



-  Direct pendulum
-  Inverted pendulum
-  Embedded strain-gauge
-  Thermometer
-  Weir (flow meter)
-  Tiltmeter (clinometer)
-  Joint meter
-  Borehole extensometer
-  Piezometer
-  Earth pressure cell
-  Water level meter
-  Survey point
-  Strong motion accelerograph

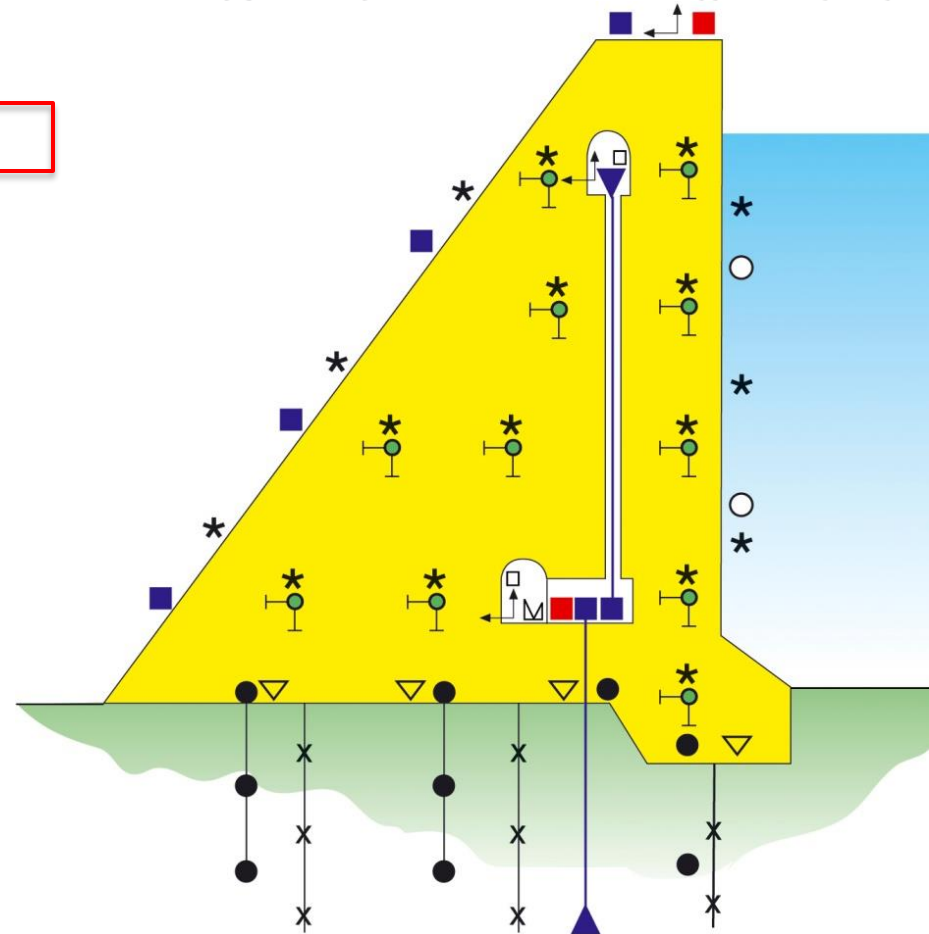

— WEIR (FLOW) METERS – V-NOTCHES

Leakage measurement is one of the most important indicator of overall performance of dams

Leakage monitoring provides data for evaluation of dam long term stability

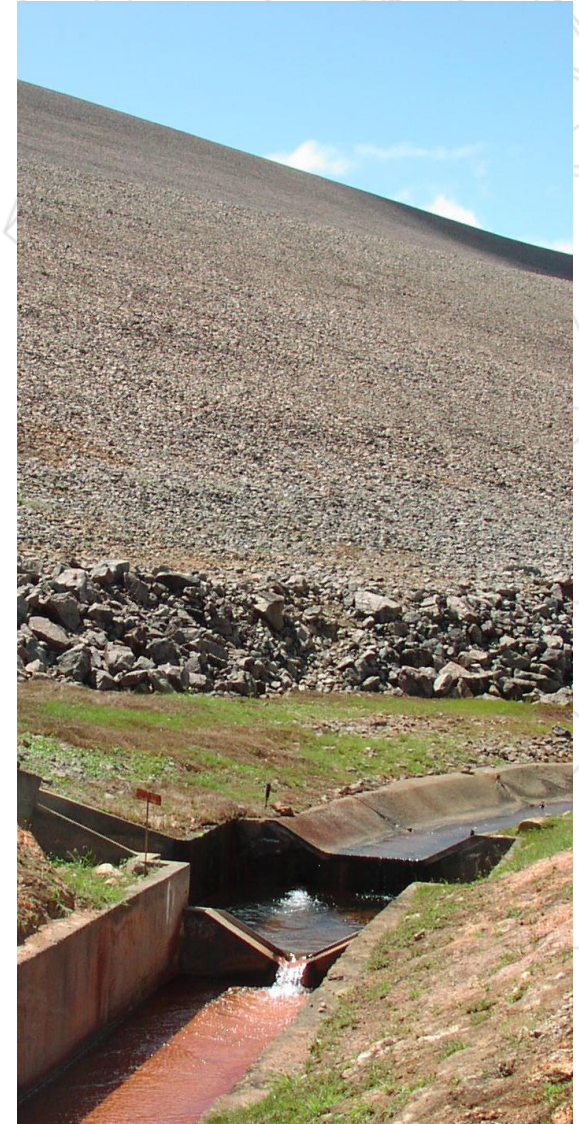

WEIR (FLOW) METERS – V-NOTCHES





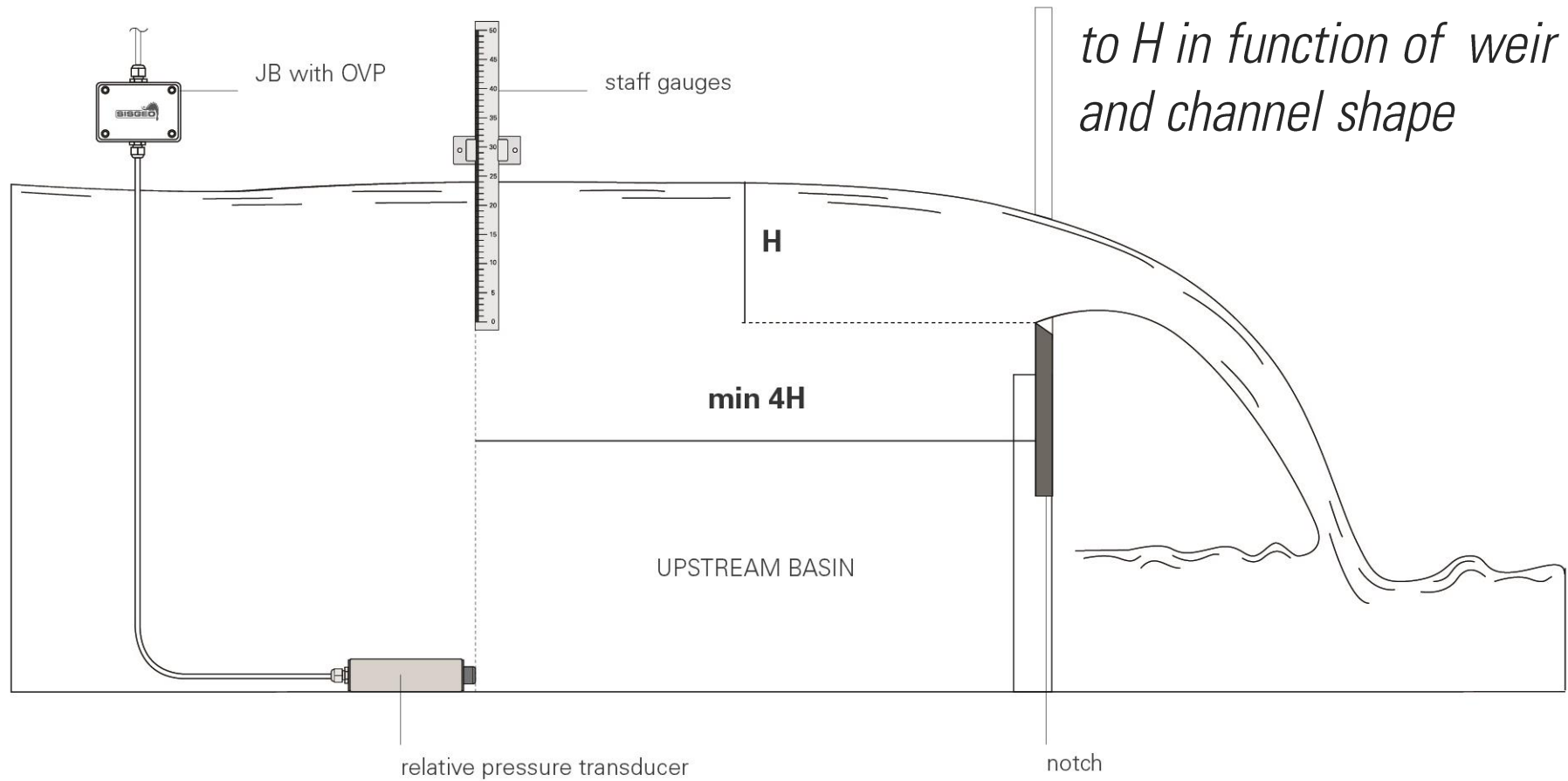



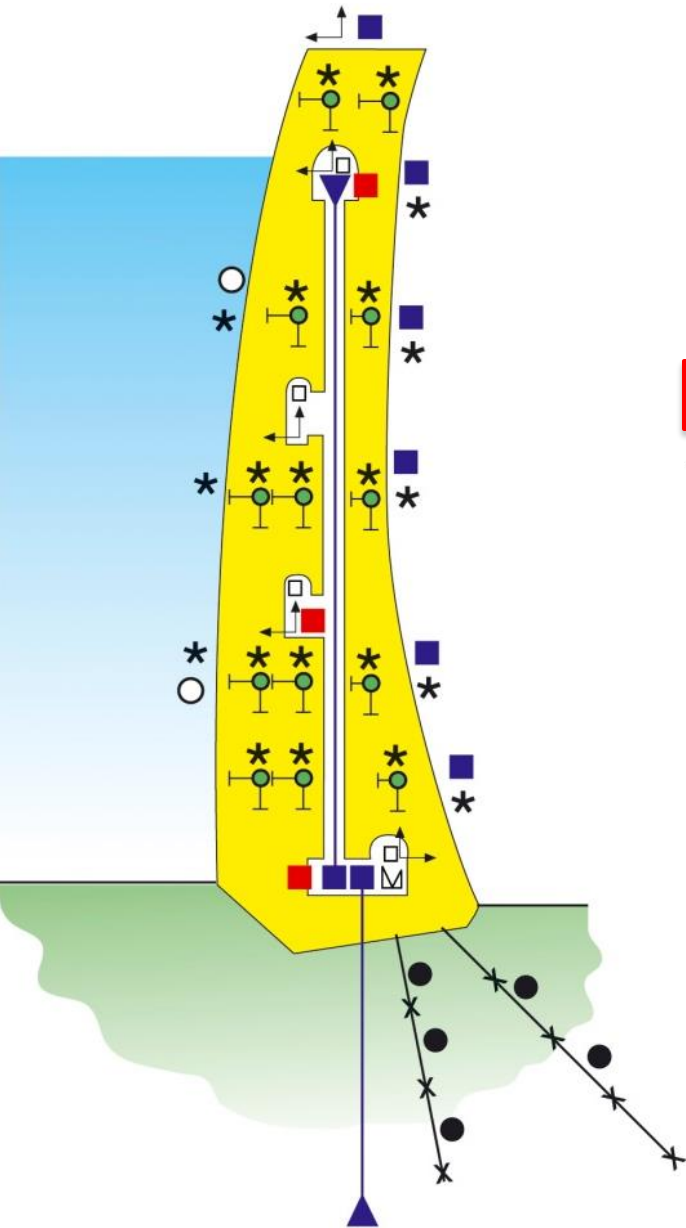



H = water head

Flow is proportional to H in function of weir and channel shape



TILT METERS (CLINOMETERS)



-  Direct pendulum
-  Inverted pendulum
-  Embedded strain-gauge
-  Thermometer
-  Weir (flow meter)
-  Tiltmeter (clinometer)
-  Joint meter
-  Borehole extensometer
-  Piezometer
-  Earth pressure cell
-  Water level meter
-  Survey point
-  Strong motion accelerograph

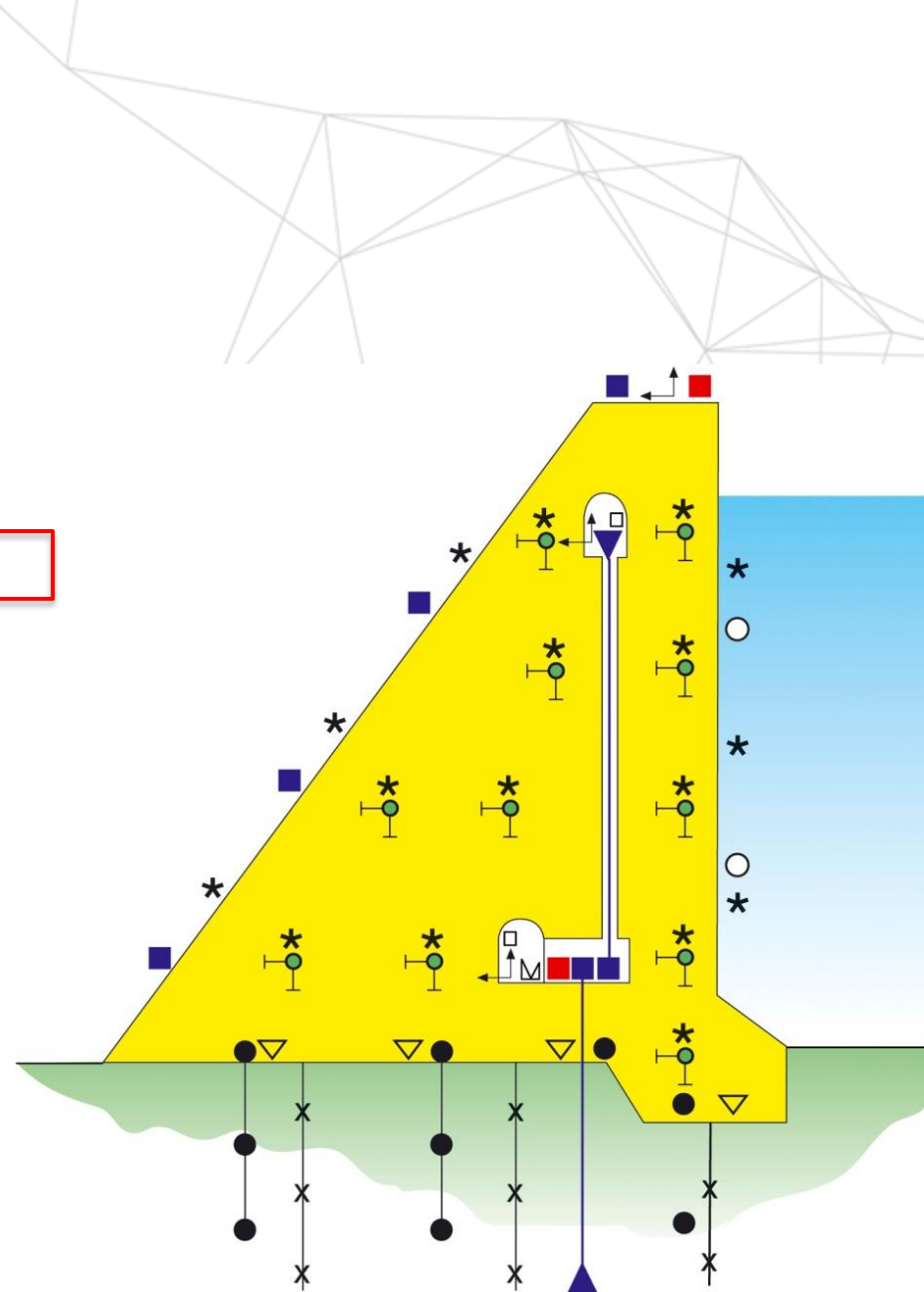

— TILT METERS (CLINOMETERS)

Tilt meters (or surface clinometers) are often used to monitor tilting and rotation on critical point or on a short base length, typically 1, 2 or 3m.

Tilt meters have last developed MEMS technology (self compensated sensor) and are available in both analogue (4-20mA) or digital model (RS485).

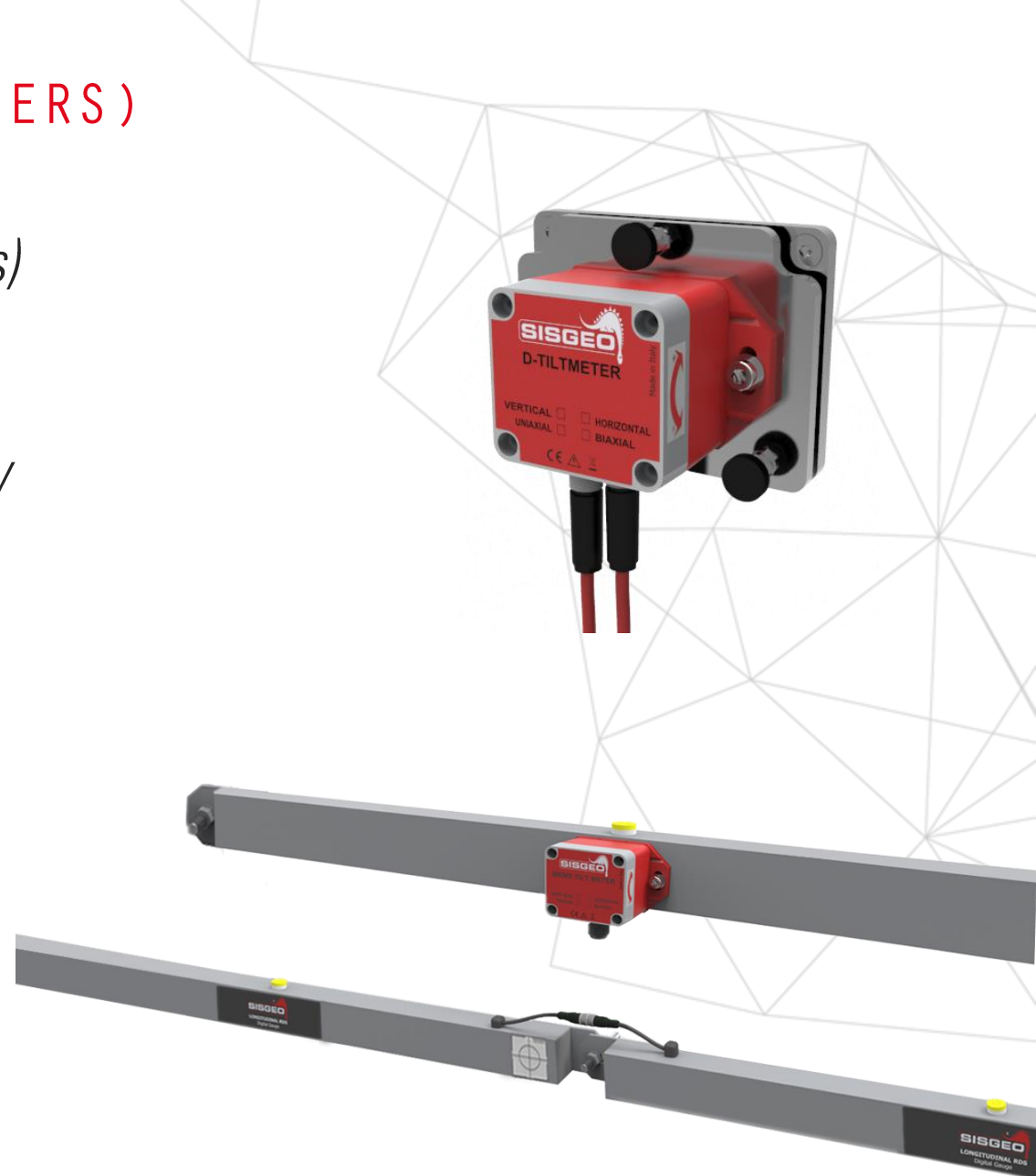

— DIGITAL TILT METERS

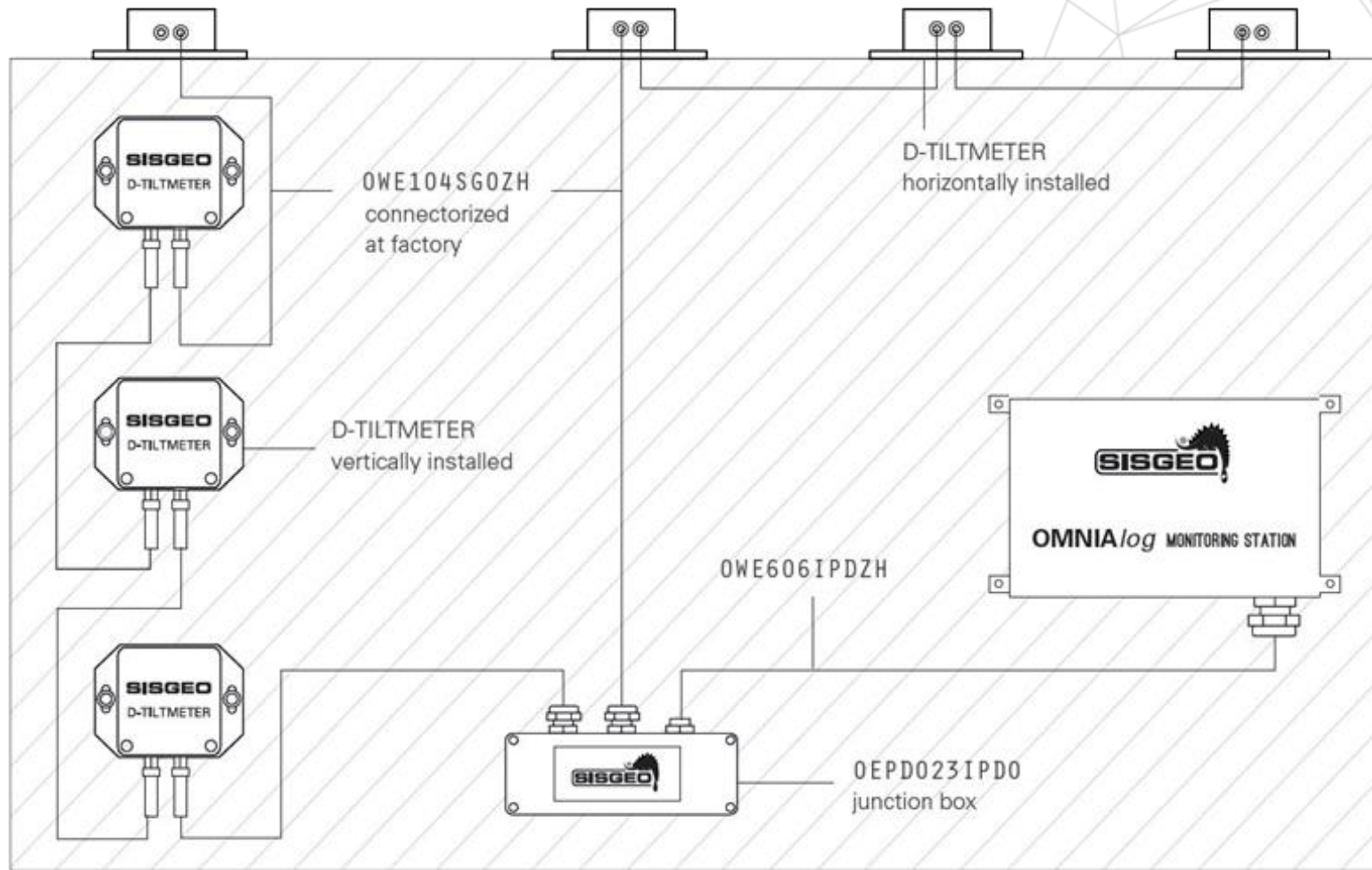

__ IP68 WATERPROOF TILTMETERS ON DAM UP-STREAM

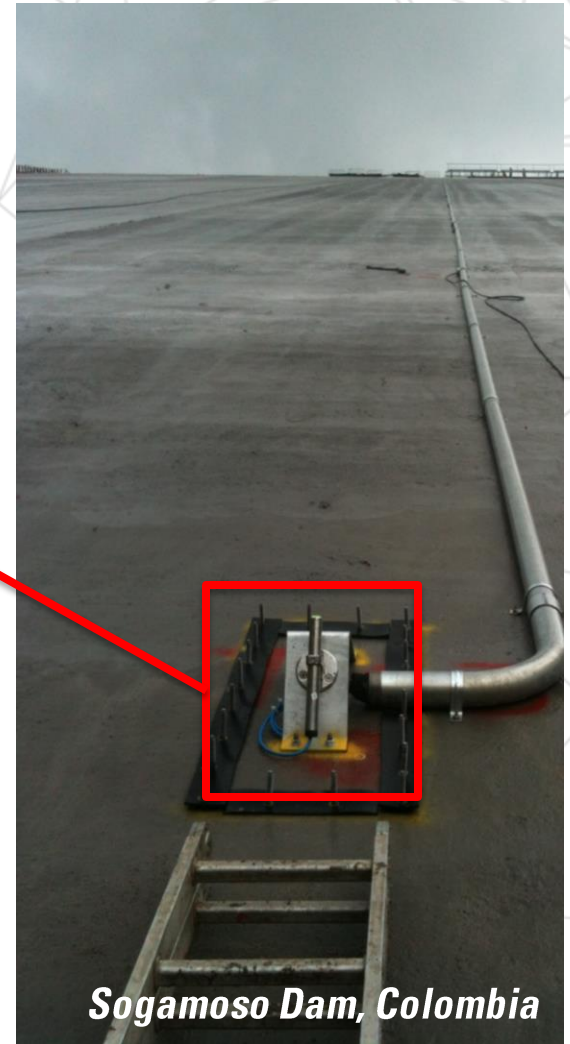

Sogamoso Dam, Colombia

__ DAM UP-STREAM AFTER INSTALLATIONS



Sogamoso Dam, Colombia

— TILT BEAM (TB) – STAND ALONE APPLICATION

Aim: measure the inclination between two points.

Available beam lengths: 1, 2 or 3 meter

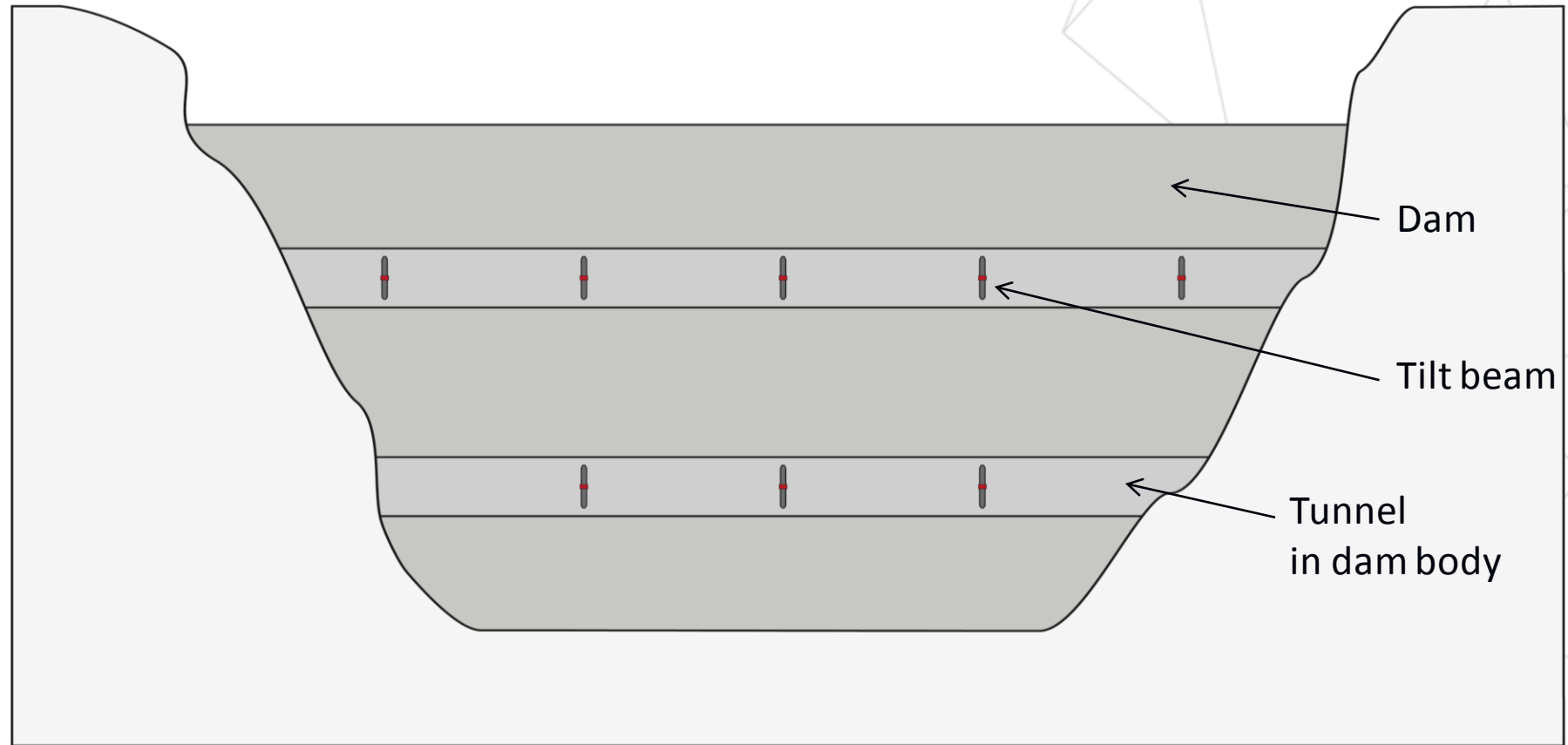



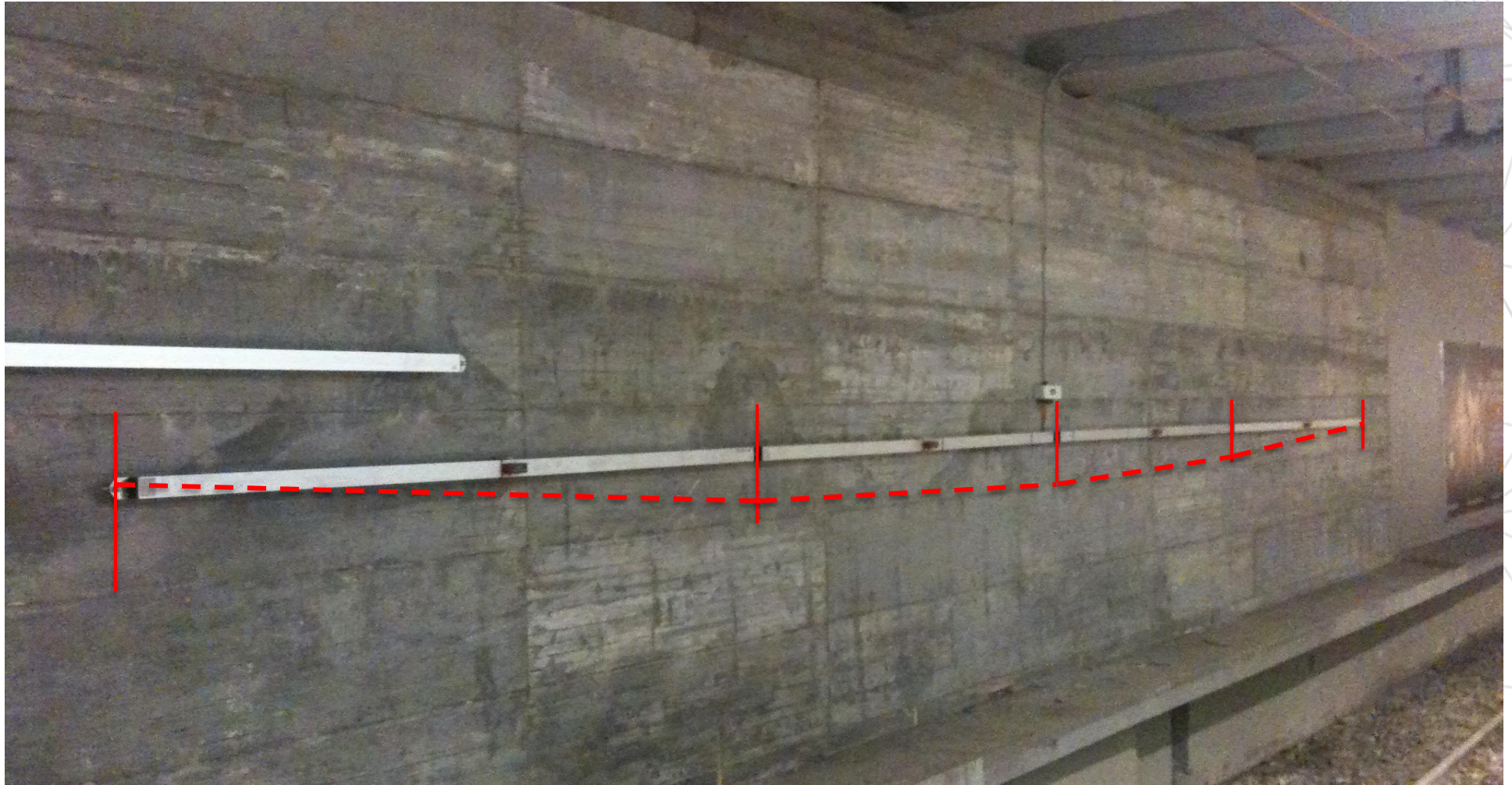



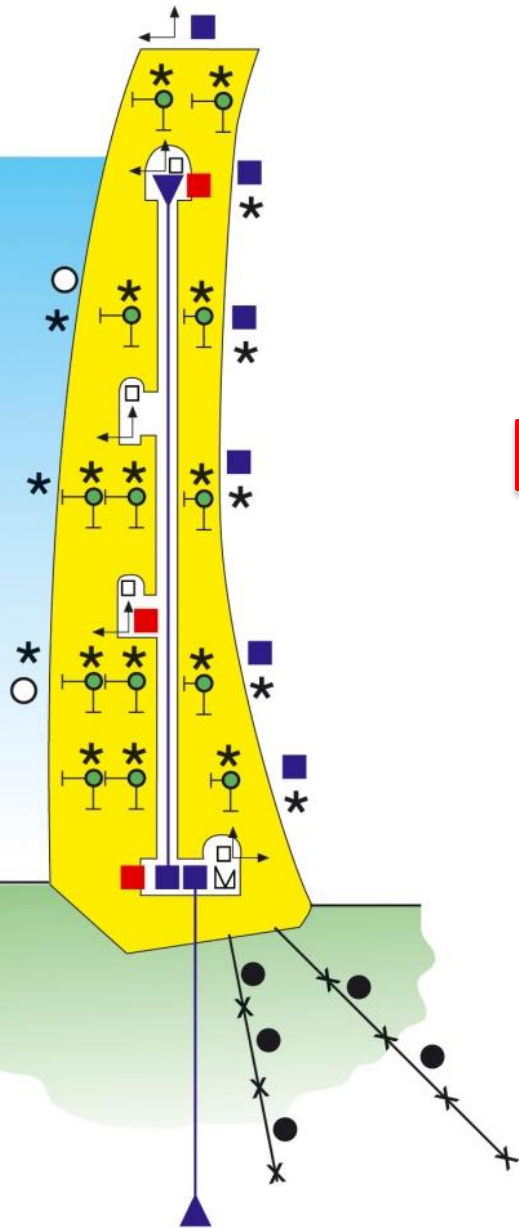





__ CHAIN OF TILT BEAMS (TB) FOR SETTLEMENT MONITORING



— JOINT METERS



-  Direct pendulum
-  Inverted pendulum
-  Embedded strain-gauge
-  Thermometer
-  Weir (flow meter)
-  Tiltmeter (clinometer)
-  Joint meter
-  Borehole extensometer
-  Piezometer
-  Earth pressure cell
-  Water level meter
-  Survey point
-  Strong motion accelerograph

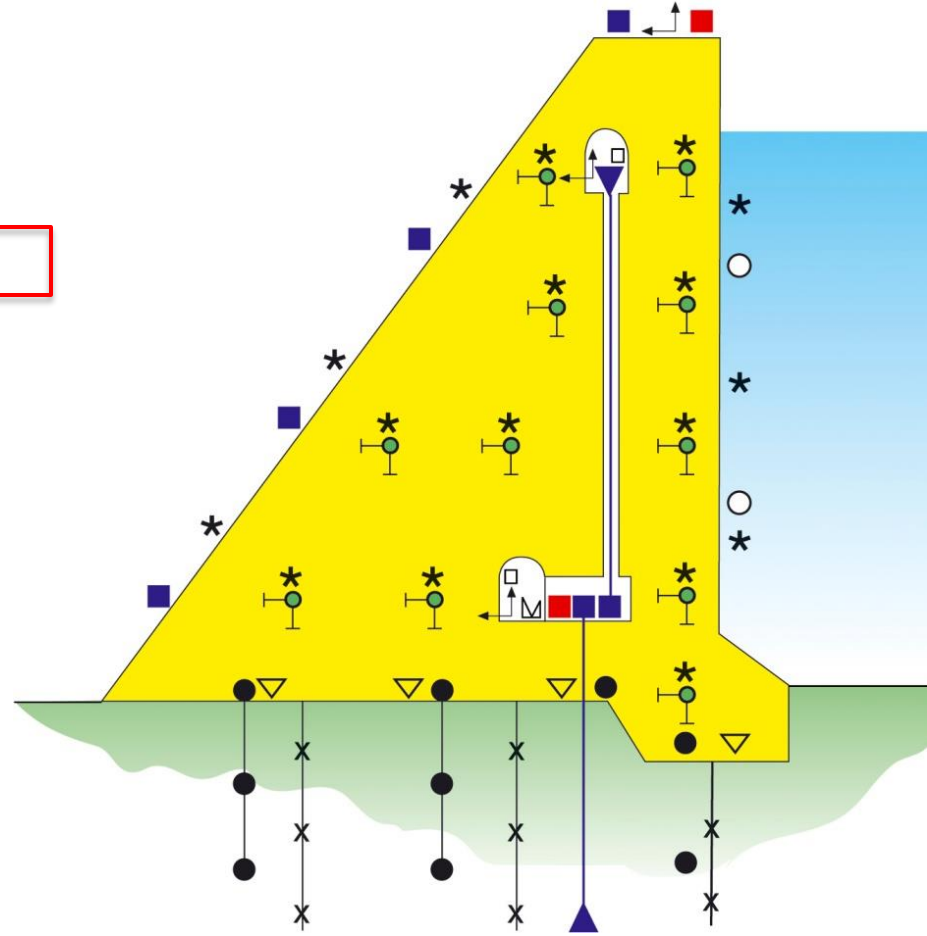

__ JOINT METER ON STRUCTURAL JOINT

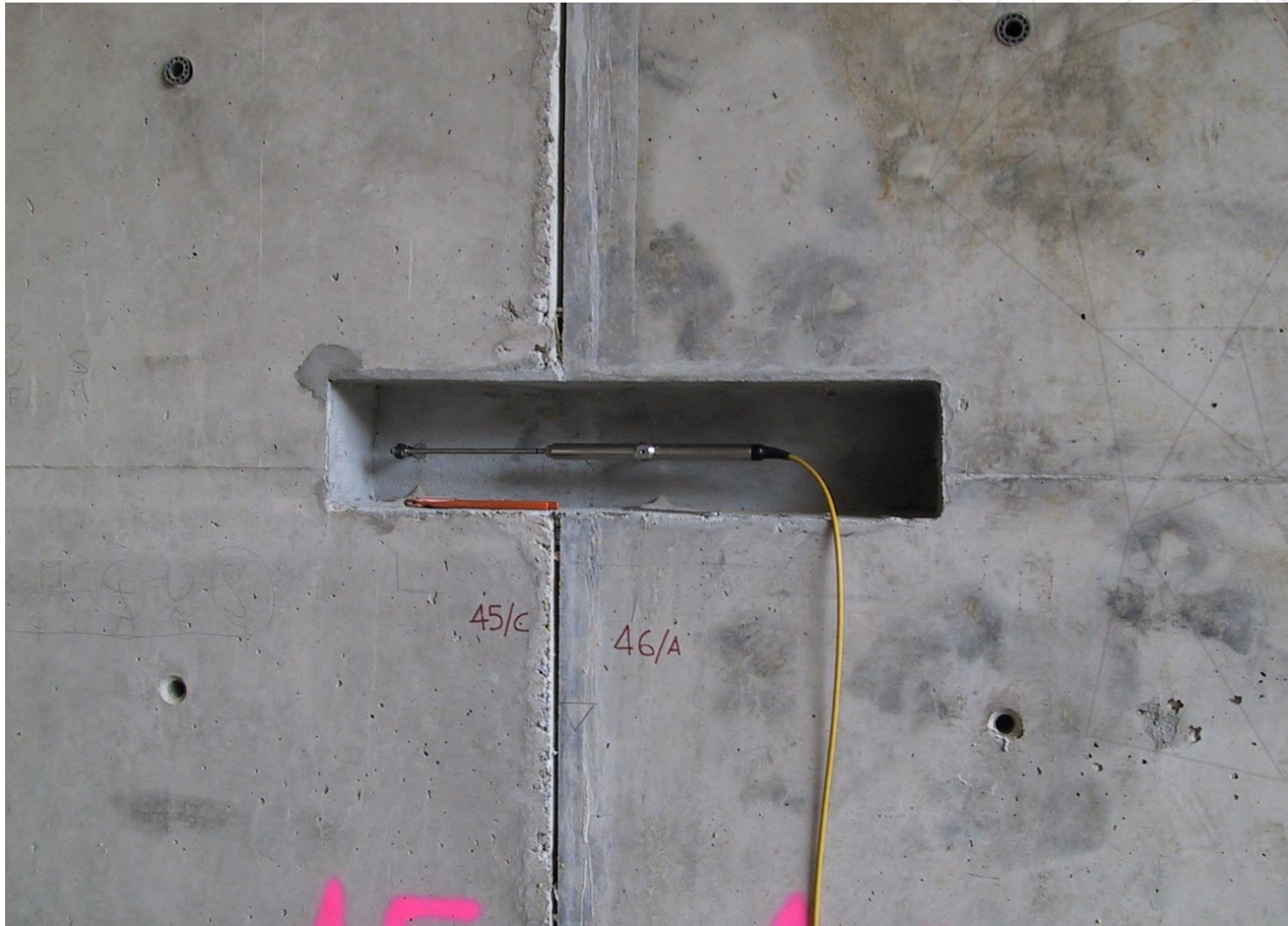





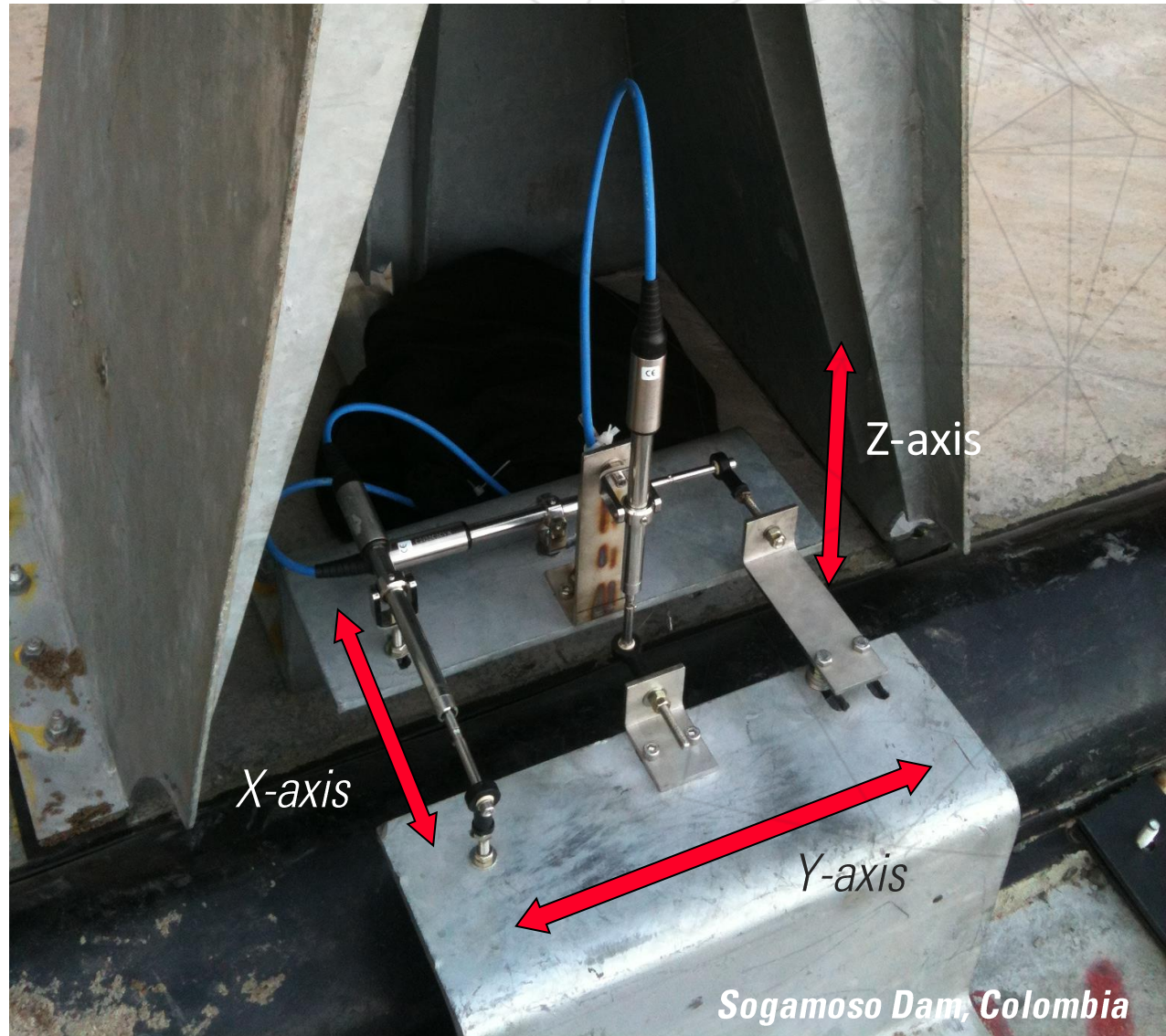



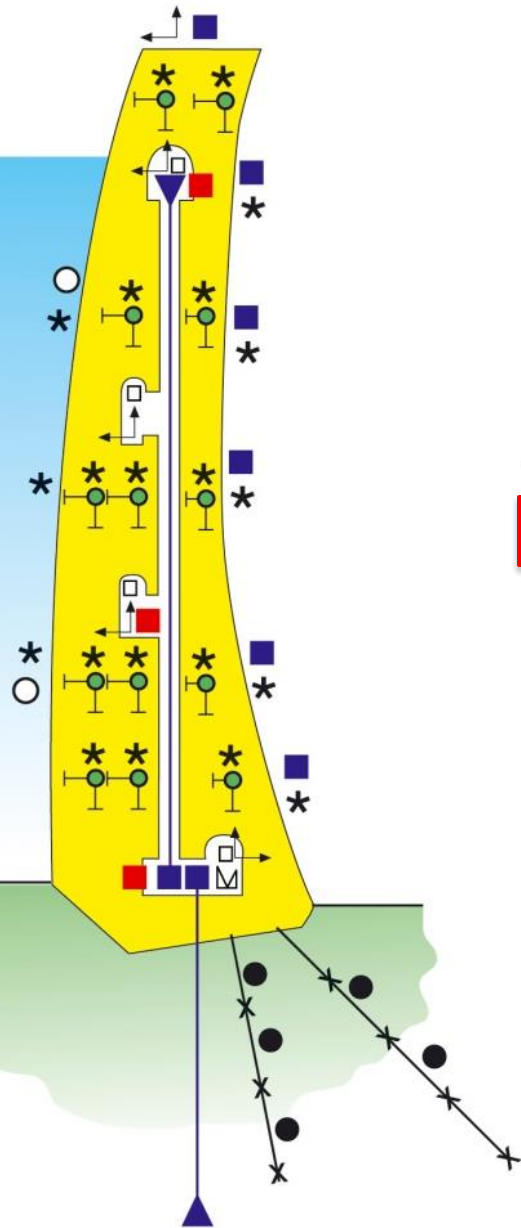





— 3-D JOINT METERS

With different model of steel supports, joint meters could be installed to measure constructive joint movements in three directions (3-D)



__ MULTIPOINT BOREHOLE EXTENSOMETERS (MPBX)



-  Direct pendulum
-  Inverted pendulum
-  Embedded strain-gauge
-  Thermometer
-  Weir (flow meter)
-  Tiltmeter (clinometer)
-  Joint meter
-  Borehole extensometer
-  Piezometer
-  Earth pressure cell
-  Water level meter
-  Survey point
-  Strong motion accelerograph

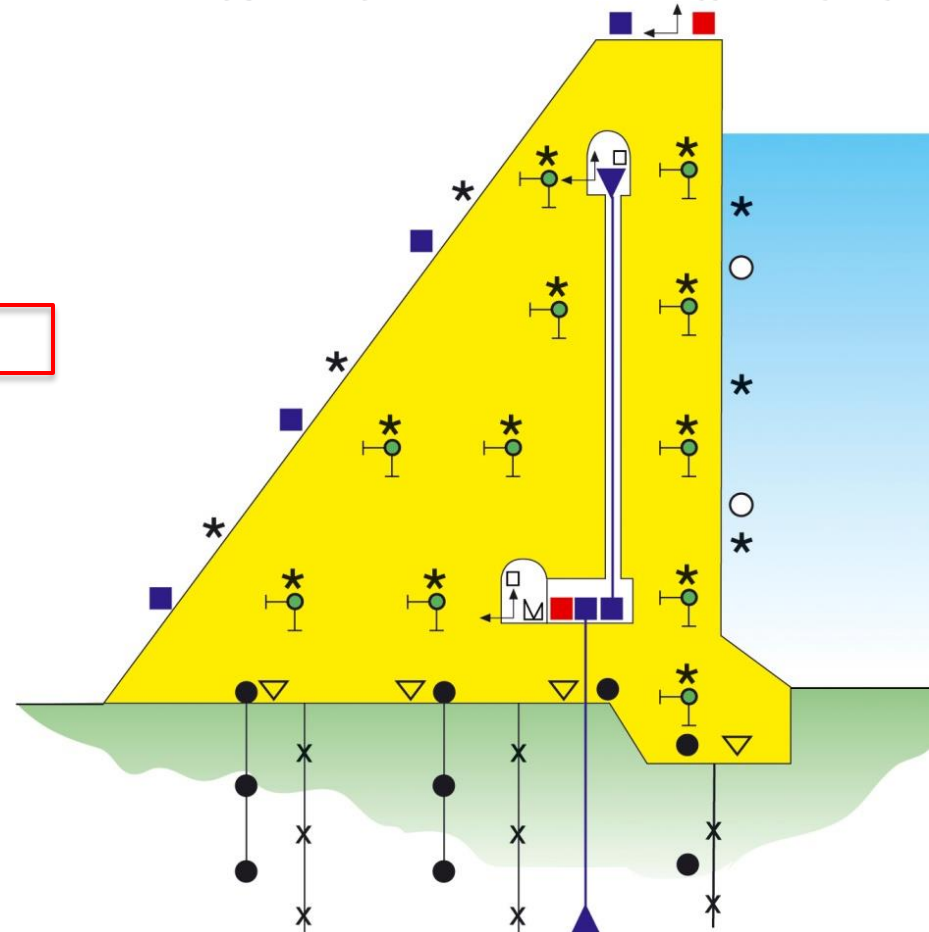

— BOREHOLE EXTENSOMETERS (MPBX)

Available with:

- *Fiber Glass rods*
- *Stainless steel rods*

*Number of rods for each extensometer:
from 2 to 6
(7 points on request)*



__ EXAMPLE OF DAM ABUTMENT MONITORING

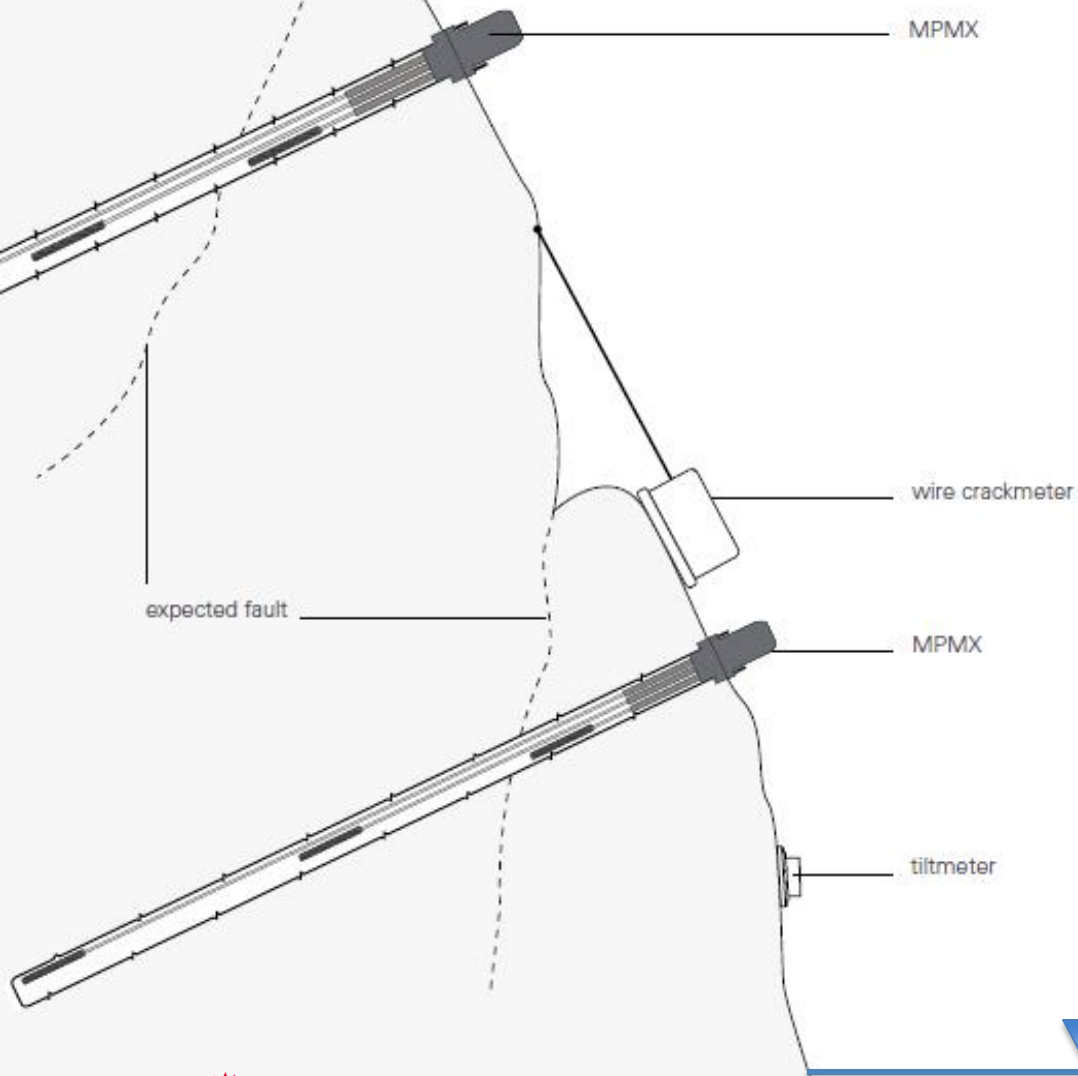

MPBX can be installed on dam abutments or on possible rockfall/ topple landslide over the reservoir.

— BOREHOLE EXTENSOMETERS (MPBX)











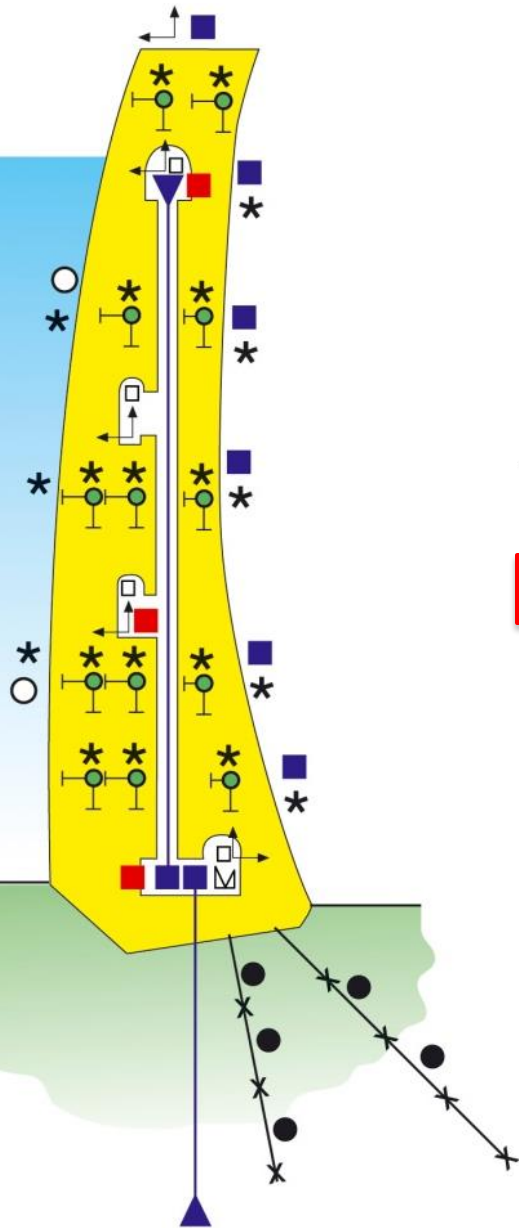





MPBX on dam abutment



MPBX in dam lower tunnel

__ PIEZOMETERS (PORE PRESSURE GAUGES)



-  Direct pendulum
-  Inverted pendulum
-  Embedded strain-gauge
-  Thermometer
-  Weir (flow meter)
-  Tiltmeter (clinometer)
-  Joint meter
-  Borehole extensometer
-  Piezometer
-  Earth pressure cell
-  Water level meter
-  Survey point
-  Strong motion accelerograph

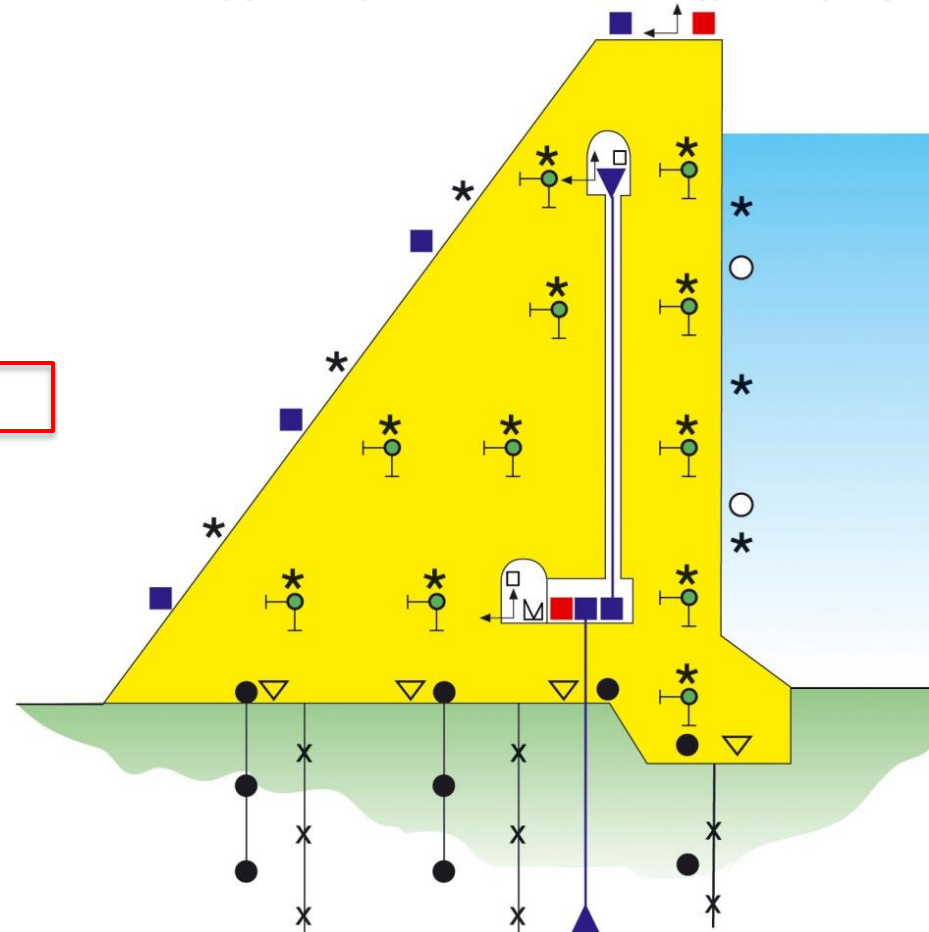

— PIEZOMETERS (PORE PRESSURE GAUGES)

Main applications (concrete dams):

- 1. Water pore pressure in dam foundations*
- 2. Up-lift pressure measurement*

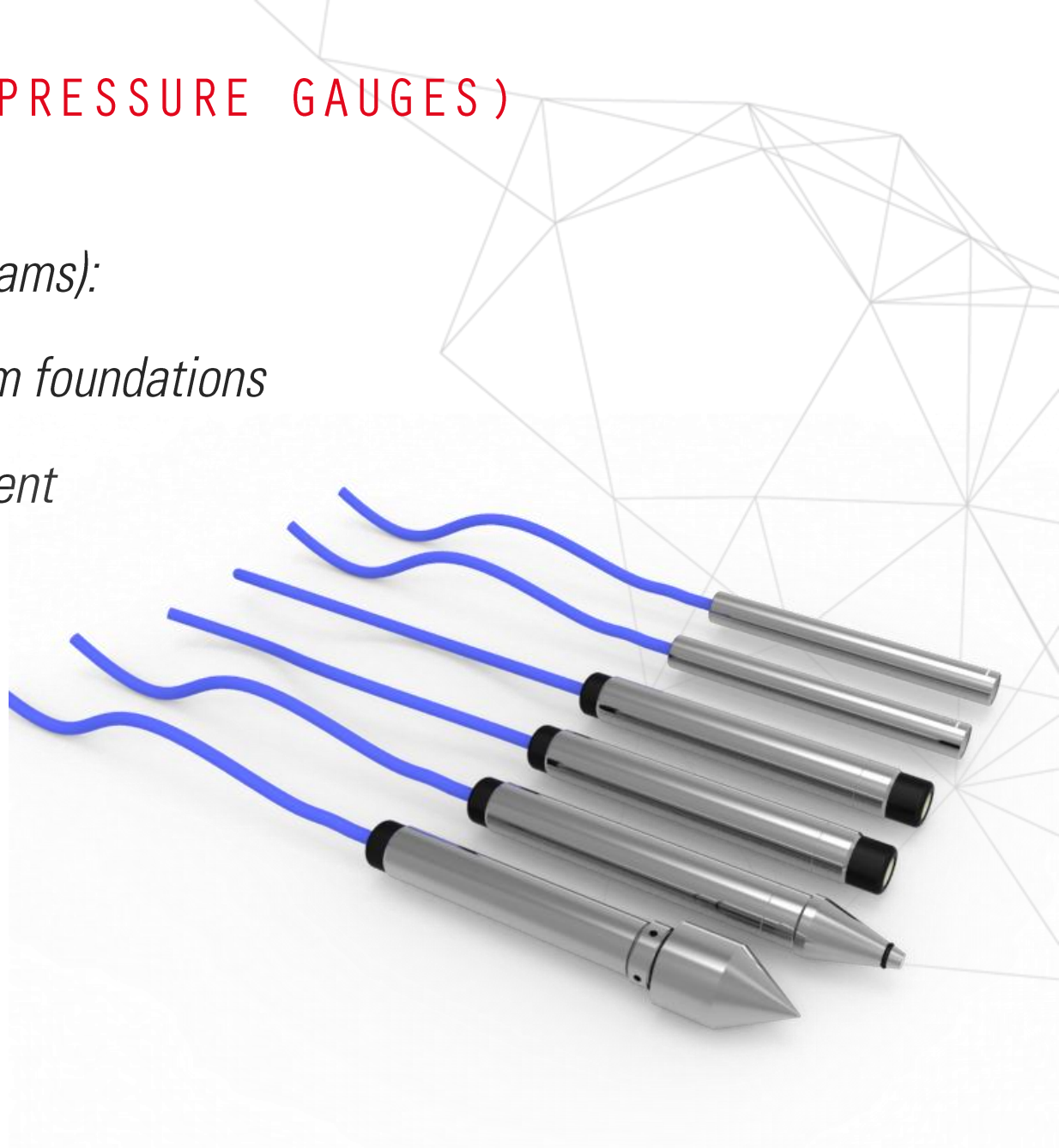

__ PORE PRESSURE: INSTALLATION PHASES



Insert the transducer in the borehole











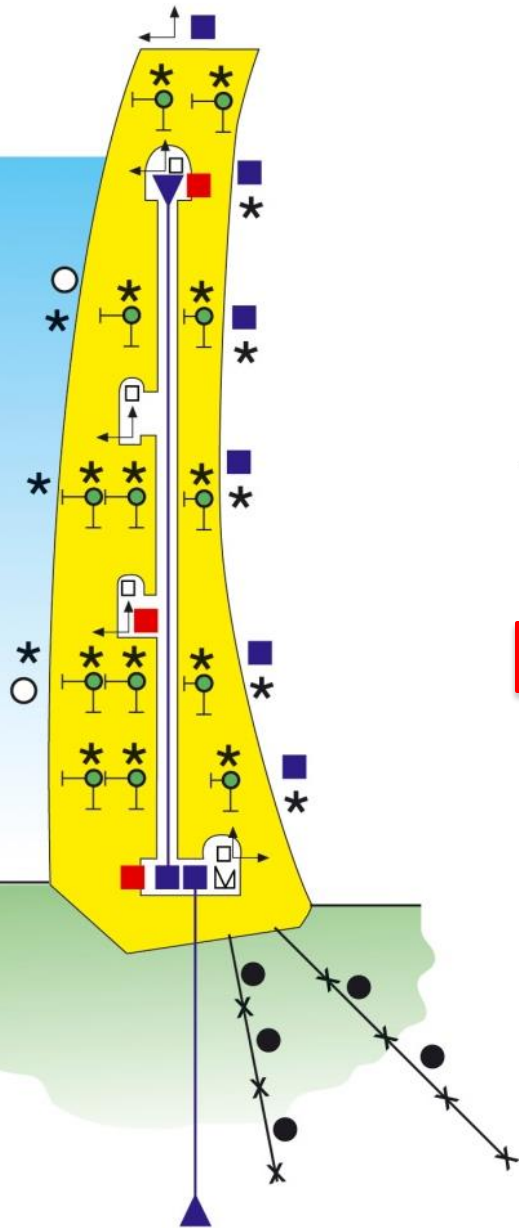





Filling with bentonite pellets (sealing)



Take zero reading

__ EARTH (TOTAL) PRESSURE CELLS



-  Direct pendulum
-  Inverted pendulum
-  Embedded strain-gauge
-  Thermometer
-  Weir (flow meter)
-  Tiltmeter (clinometer)
-  Joint meter
-  Borehole extensometer
-  Piezometer
-  Earth pressure cell
-  Water level meter
-  Survey point
-  Strong motion accelerograph

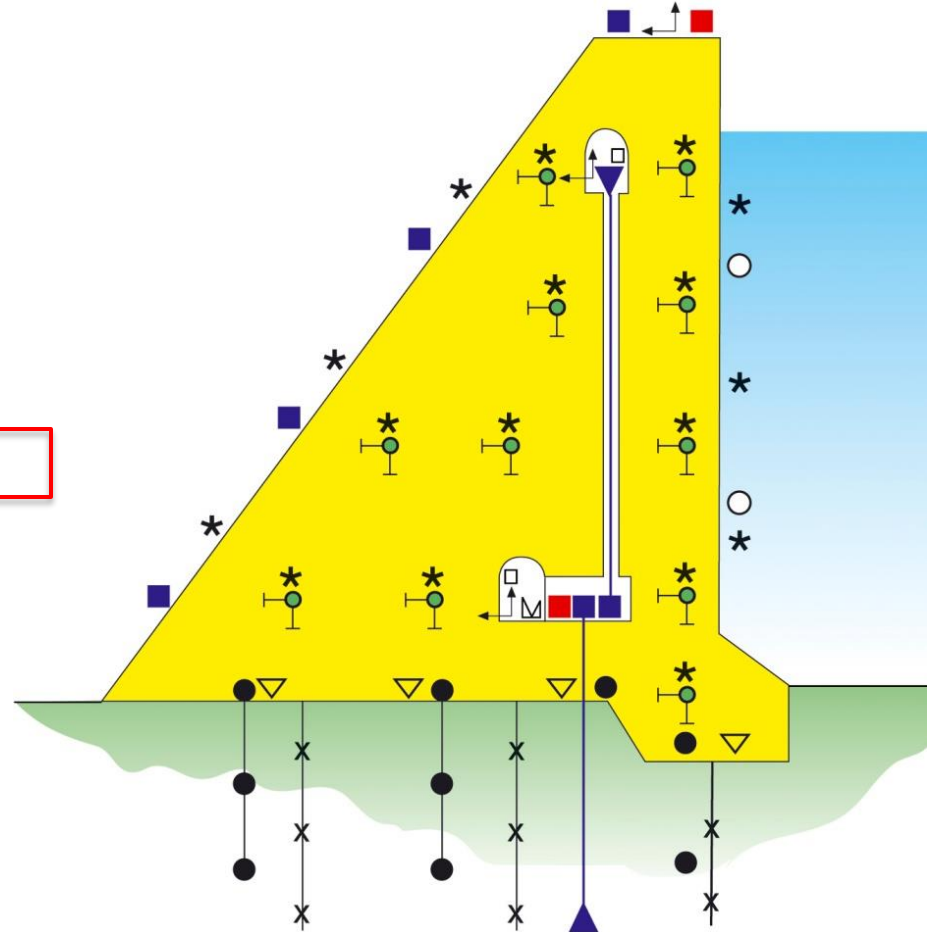

— EARTH (TOTAL) PRESSURE CELLS









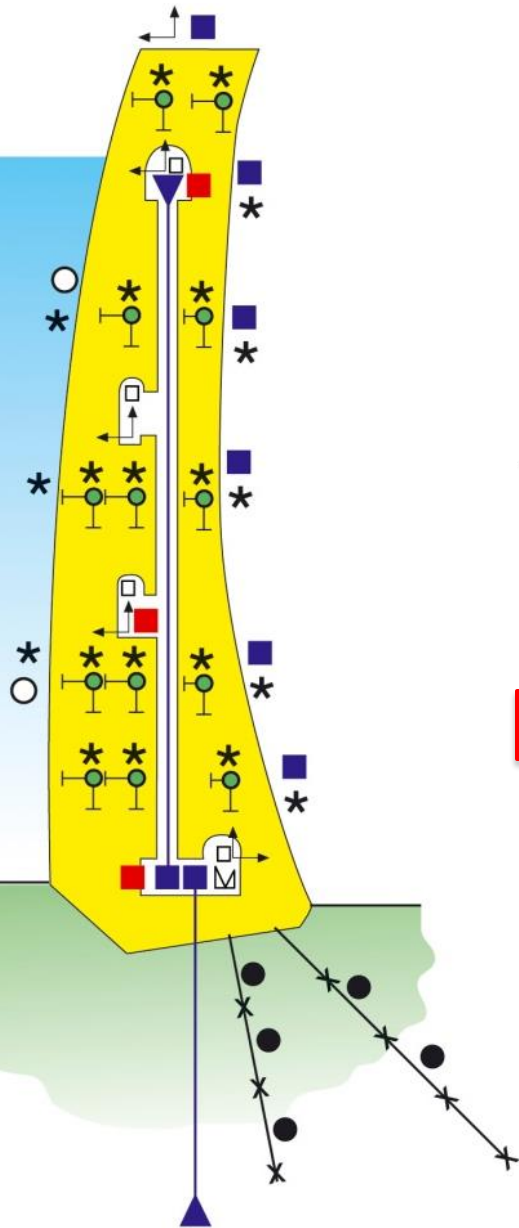





They are installed in order to monitor the pressure applied from the growth of the dam body.

The main application is in earth fill dams or embankments

__ WATER LEVEL METER (WATER BASIN LEVEL)



-  Direct pendulum
-  Inverted pendulum
-  Embedded strain-gauge
-  Thermometer
-  Weir (flow meter)
-  Tiltmeter (clinometer)
-  Joint meter
-  Borehole extensometer
-  Piezometer
-  Earth pressure cell
-  Water level meter
-  Survey point
-  Strong motion accelerograph

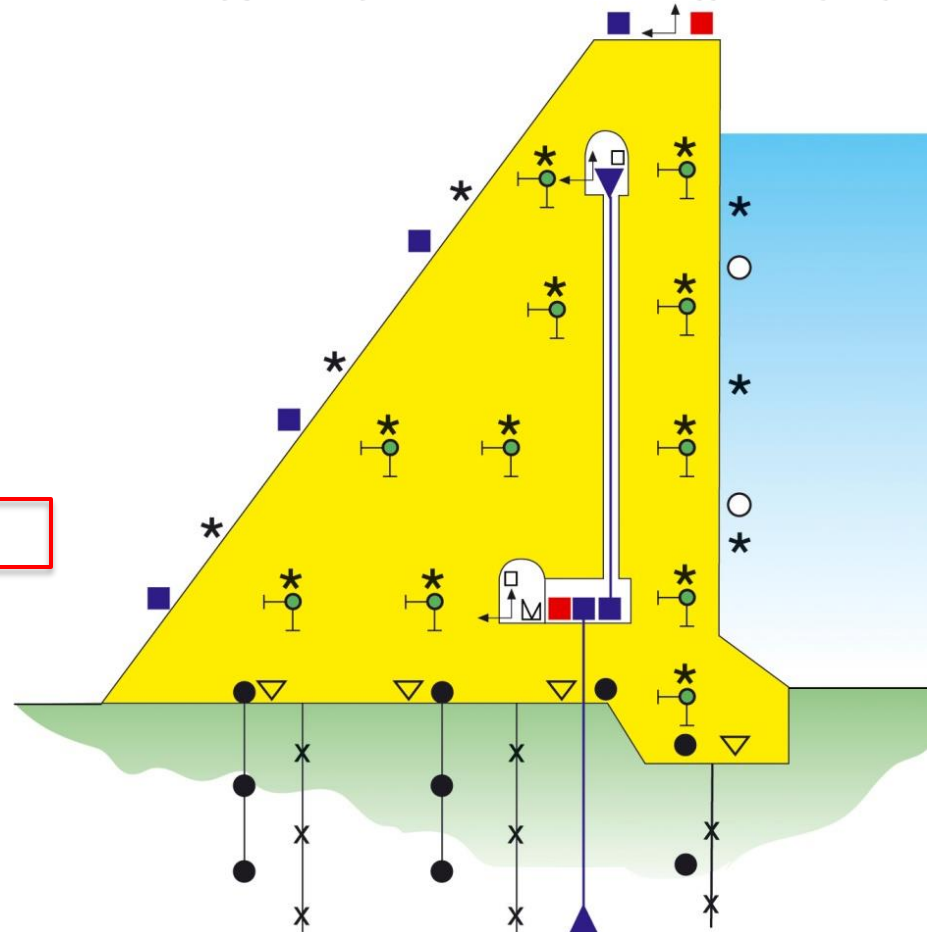

WATER BASIN LEVEL – STAFF GAUGES

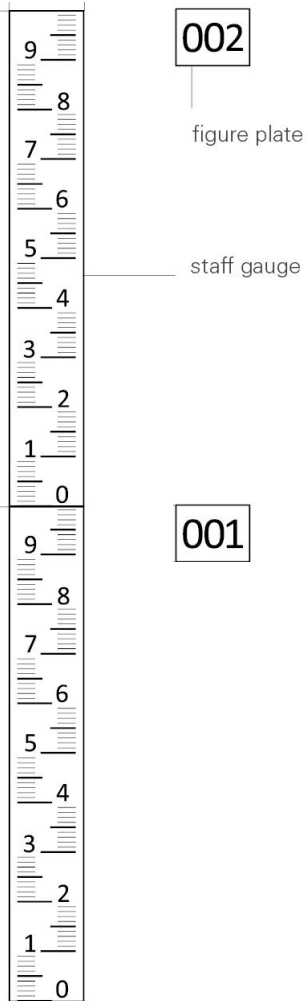

*Chain of
staff gauges*









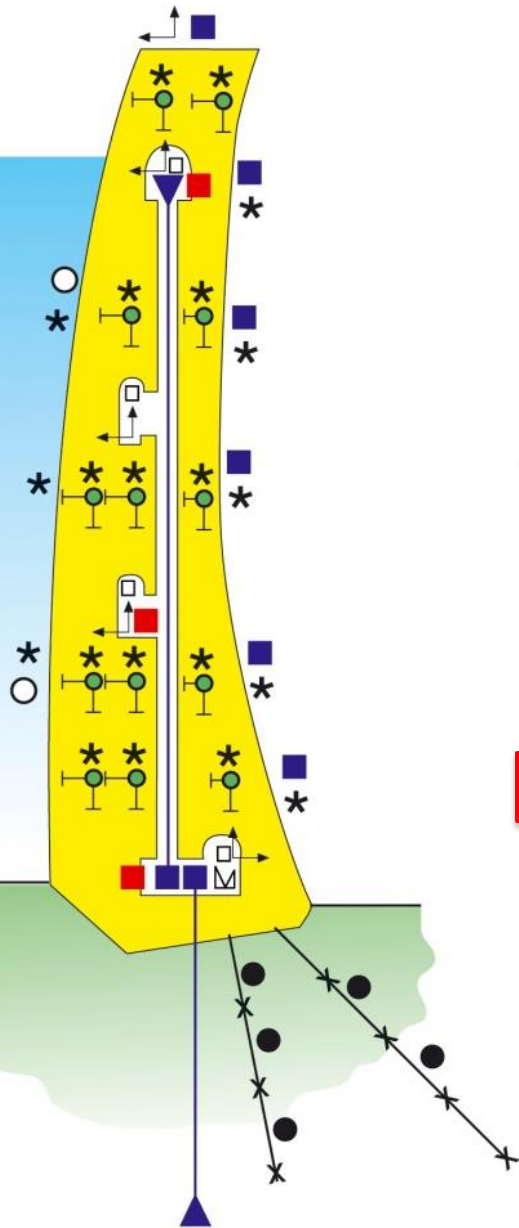



Al Wehda Dam, Jordan

__ WATER BASIN LEVEL – ULTRASONIC GAUGE



__ SURVEY POINTS (GEODETICAL MEASUREMENTS)



-  Direct pendulum
-  Inverted pendulum
-  Embedded strain-gauge
-  Thermometer
-  Weir (flow meter)
-  Tiltmeter (clinometer)
-  Joint meter
-  Borehole extensometer
-  Piezometer
-  Earth pressure cell
-  Water level meter
-  Survey point
-  Strong motion accelerograph

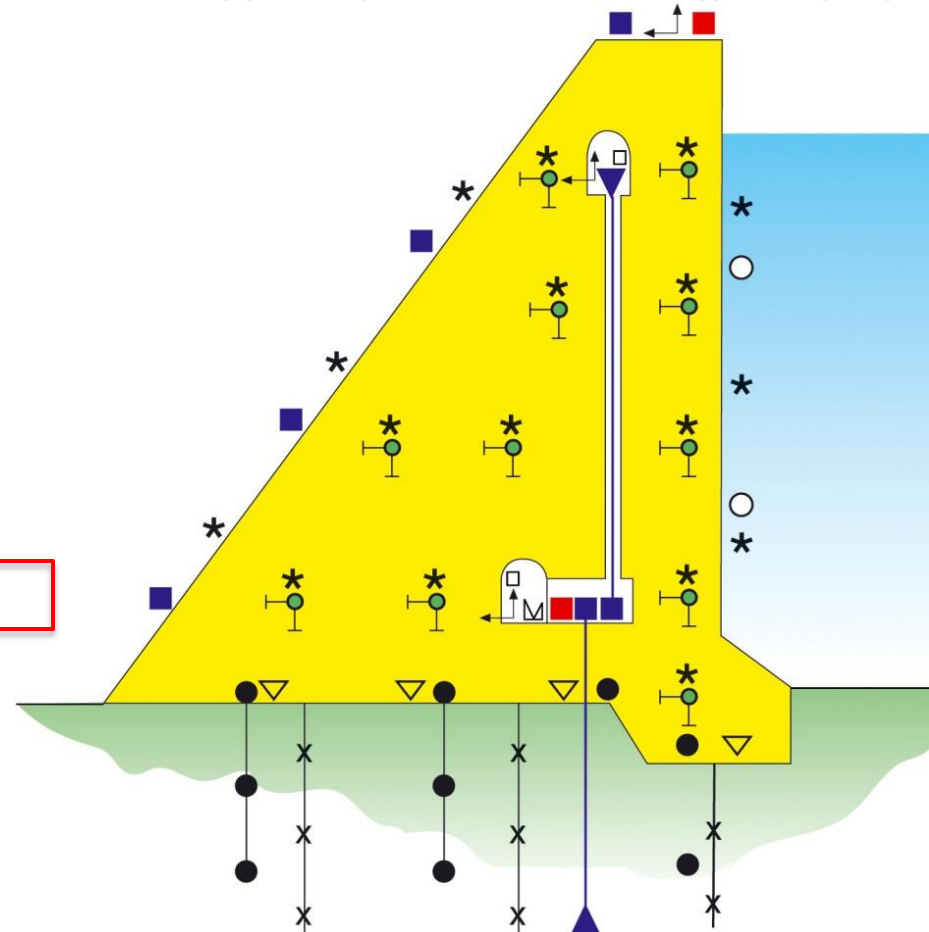







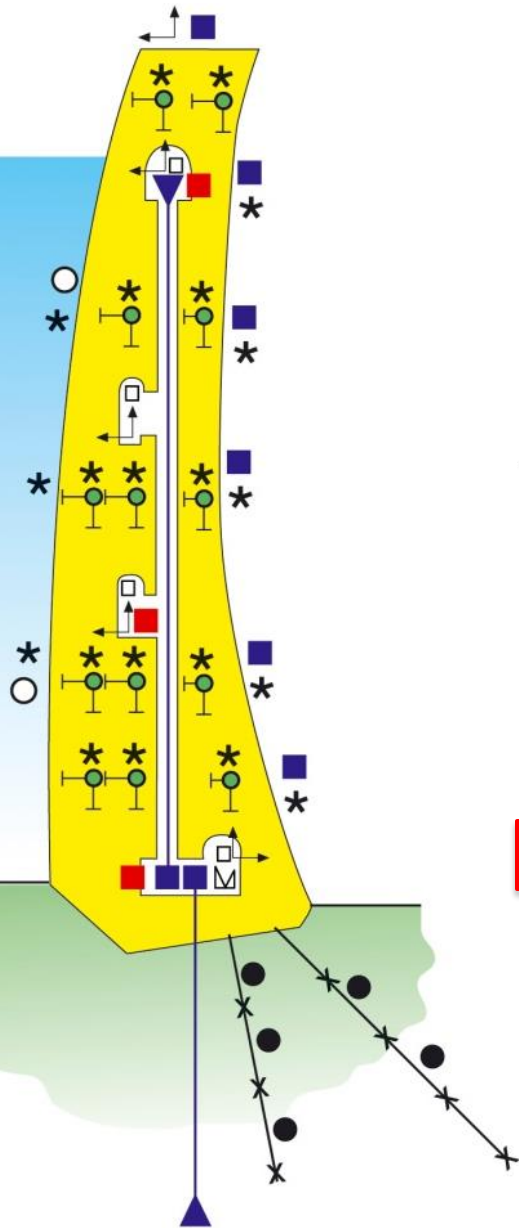





— SURVEY POINTS (BENCHMARKS, PRISMS, ETC...)



__ SURVEY POINTS (GEODETICAL MEASUREMENTS)



-  Direct pendulum
-  Inverted pendulum
-  Embedded strain-gauge
-  Thermometer
-  Weir (flow meter)
-  Tiltmeter (clinometer)
-  Joint meter
-  Borehole extensometer
-  Piezometer
-  Earth pressure cell
-  Water level meter
-  Survey point
-  Strong motion accelerograph

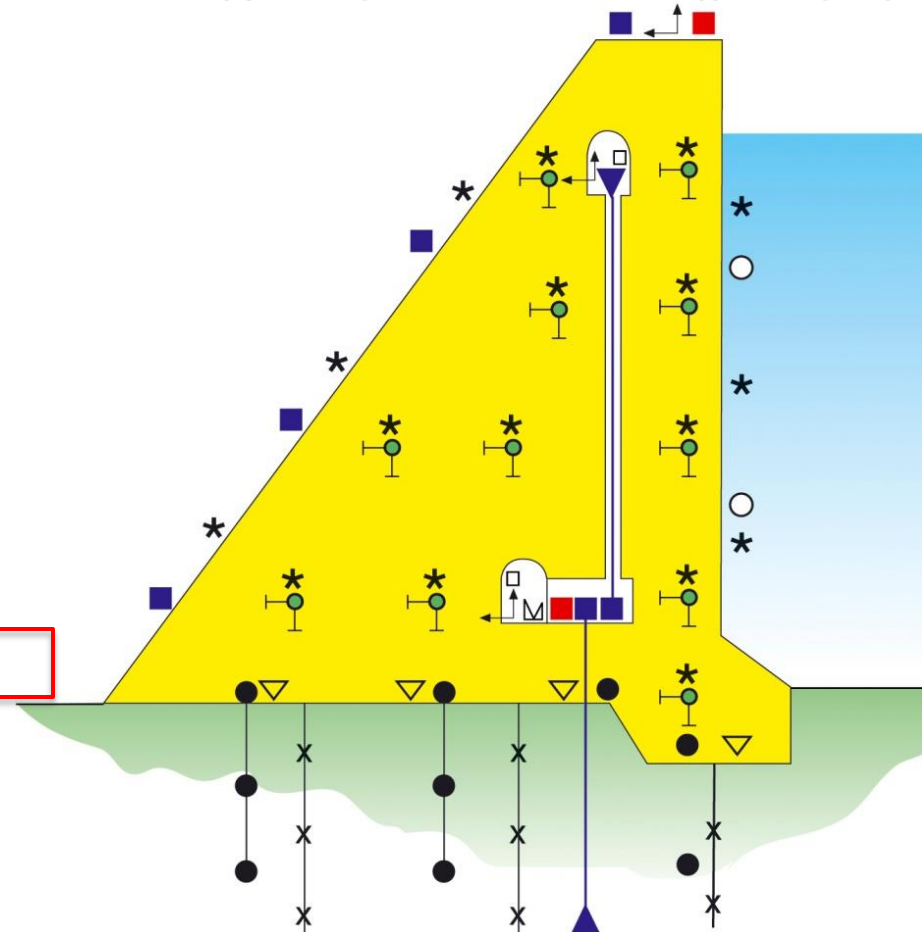

— STRONG MOTION ACCELEROGRAPH



EMBANKMENT DAMS

- Piezometer (pore pressure)
- ▽ Earth (total) pressure cell
- ⊕ Embankment extensometer
- ∥ Inclino-settlement column
- ∩ Casagrande piezometer
- Water level meter
- ∩ Weir (flow meter)
- Survey point
- Strong motion accelerograph

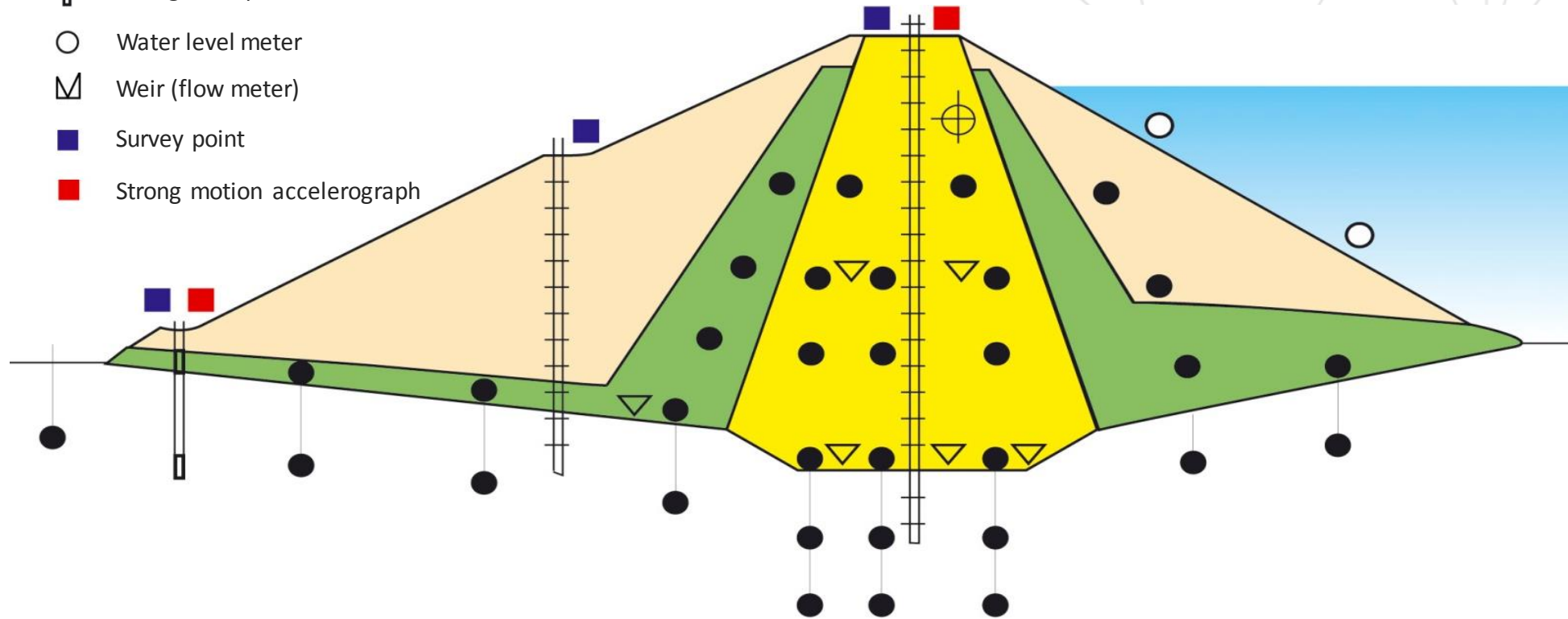

PIEZOMETERS (PORE PRESSURE)

- Piezometer (pore pressure)
- ▽ Earth (total) pressure cell
- ⊕ Embankment extensometer
- ∥ Inclino-settlement column
- ∩ Casagrande piezometer
- Water level meter
- ∇ Weir (flow meter)
- Survey point
- Strong motion accelerograph

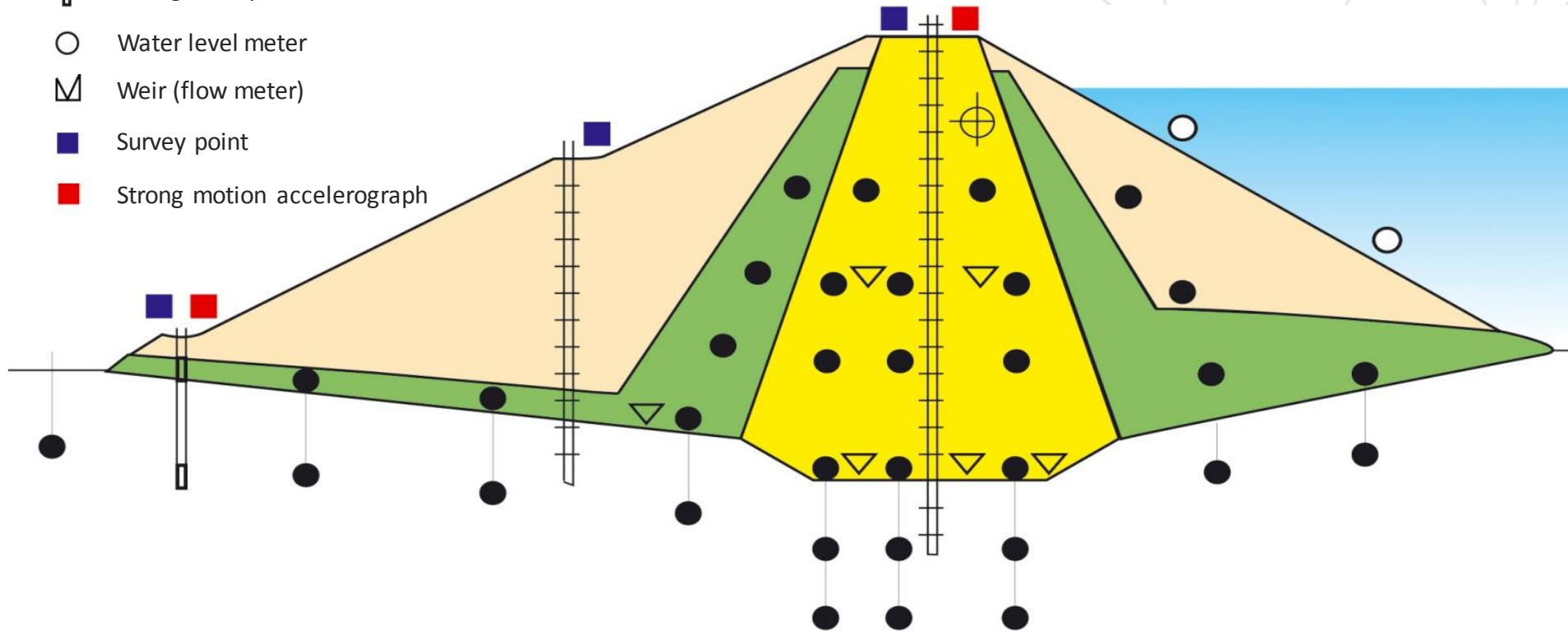

— PIEZOMETERS (PORE PRESSURE)

Main application (embankment dam):

*Pore pressure behaviour in
dam body and
foundations*



__ PIEZOMETERS (PORE PRESSURE)

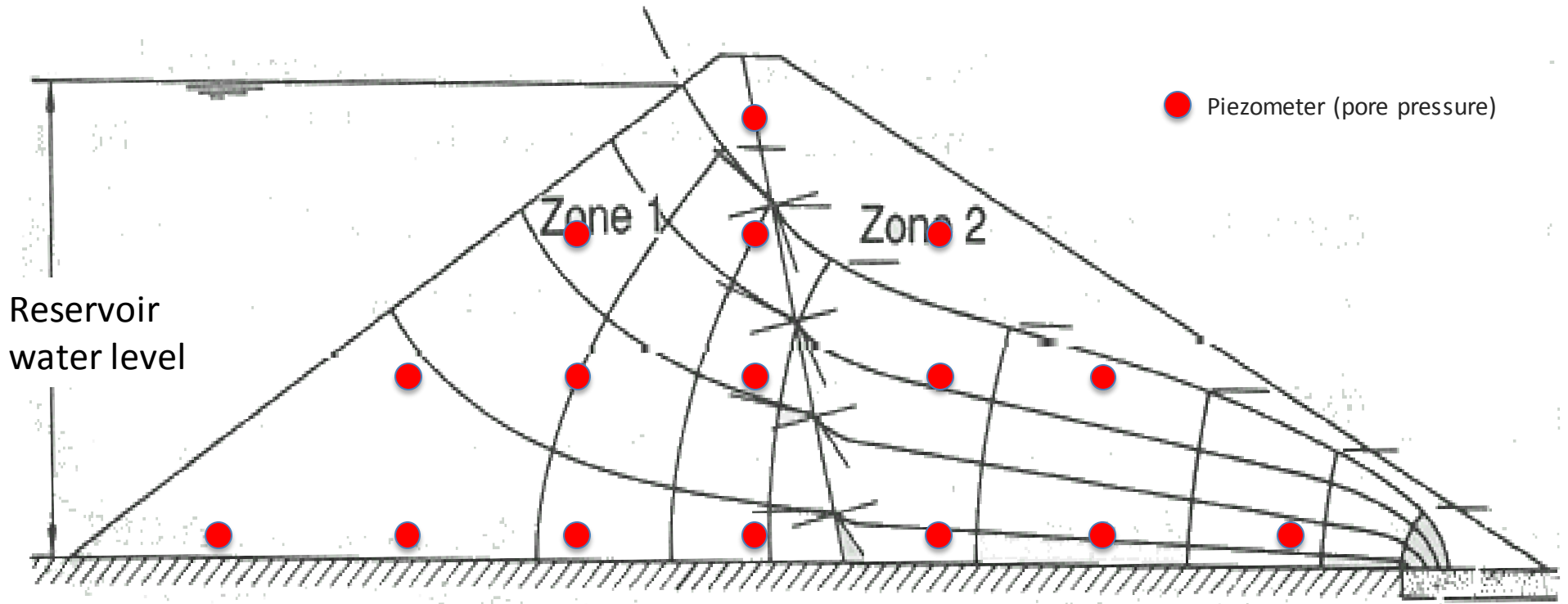

*Example of water filtration in homogeneous embankment dam with drainage.
VW piezometer monitor pressure in different points.*

__ PIEZOMETERS (PORE PRESSURE IN FOUNDATION)



— EARTH (TOTAL) PRESSURE CELL

- Piezometer (pore pressure)
- ▽ Earth (total) pressure cell
- ⊕ Embankment extensometer
- ‡ Inclino-settlement column
- ⏊ Casagrande piezometer
- Water level meter
- ∇ Weir (flow meter)
- Survey point
- Strong motion accelerograph

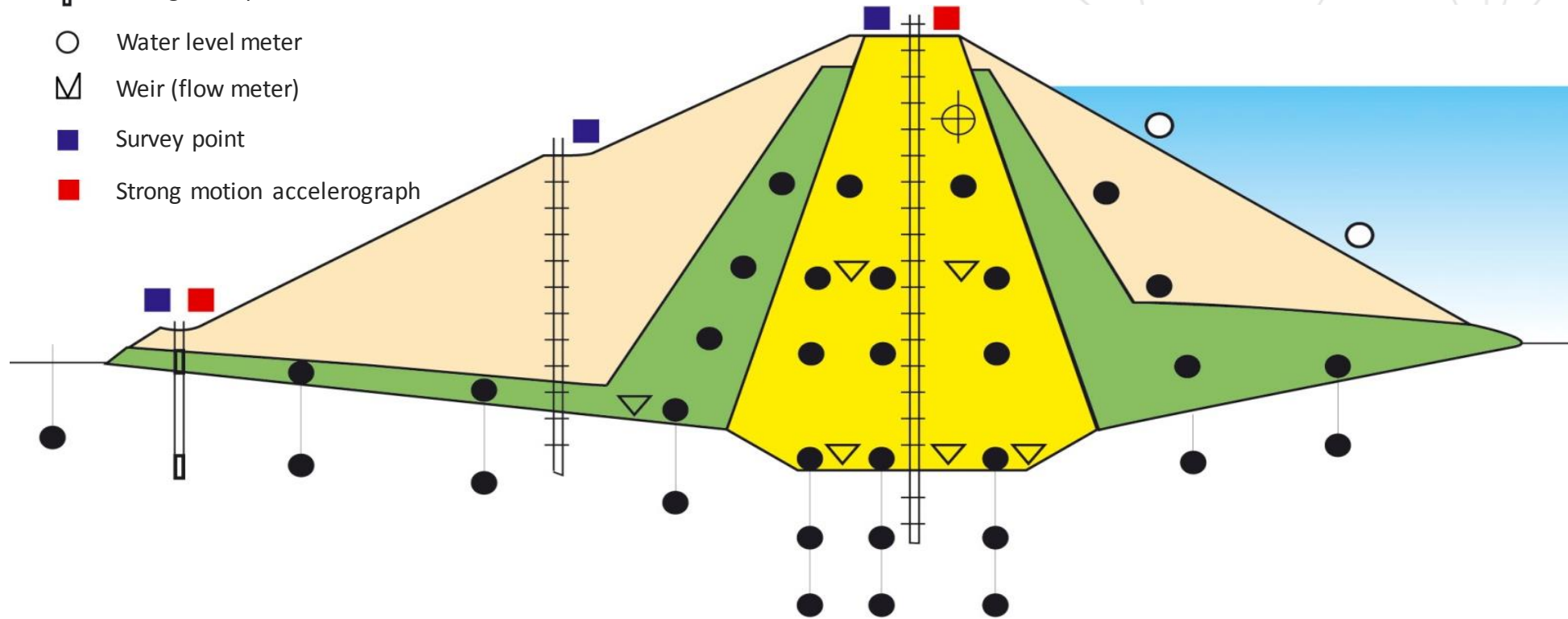

— EARTH (TOTAL) PRESSURE CELL



*Taking zero
reading*

EMBANKMENT EXTENSOMETER

- Piezometer (pore pressure)
- ▽ Earth (total) pressure cell
- ⊕ Embankment extensometer
- ≡ Inclino-settlement column
- ⏏ Casagrande piezometer
- Water level meter
- ∇ Weir (flow meter)
- Survey point
- Strong motion accelerograph

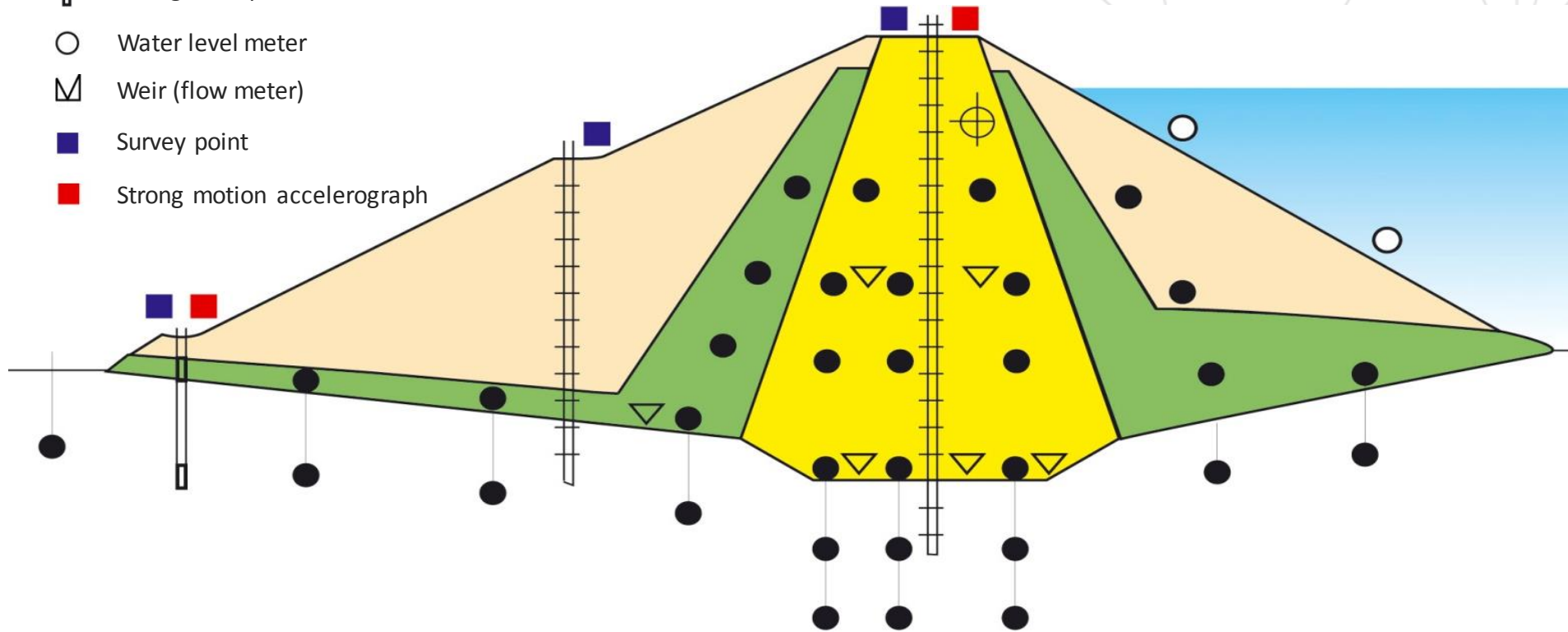

— EMBANKMENT EXTENSOMETER



They are usually incorporated in the filling material, chained together by means of extension rod and sensed section.

INCLINO-SETTLEMENT COLUMN

- Piezometer (pore pressure)
- ▽ Earth (total) pressure cell
- ⊕ Embankment extensometer
- ⊥ Inclino-settlement column
- ⊥ Casagrande piezometer
- Water level meter
- ∇ Weir (flow meter)
- Survey point
- Strong motion accelerograph

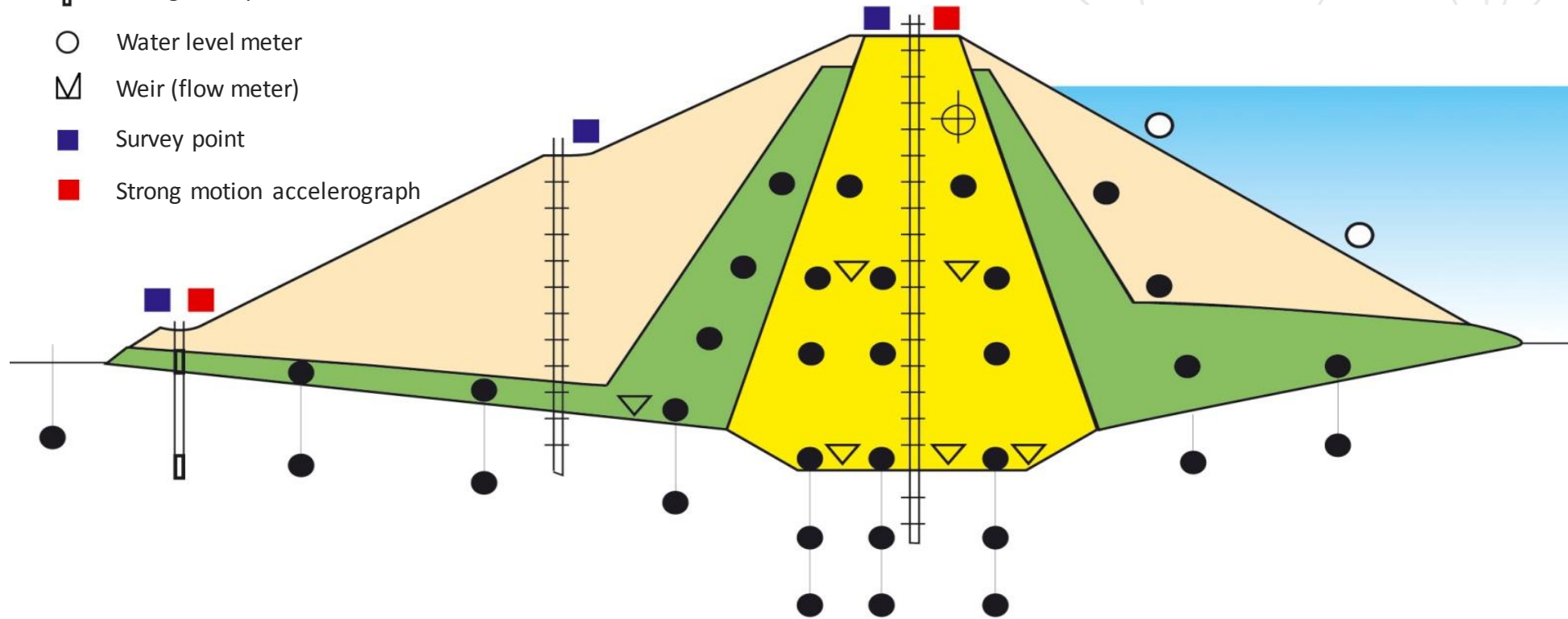

__ INCLINO-SETTLEMENT COLUMN

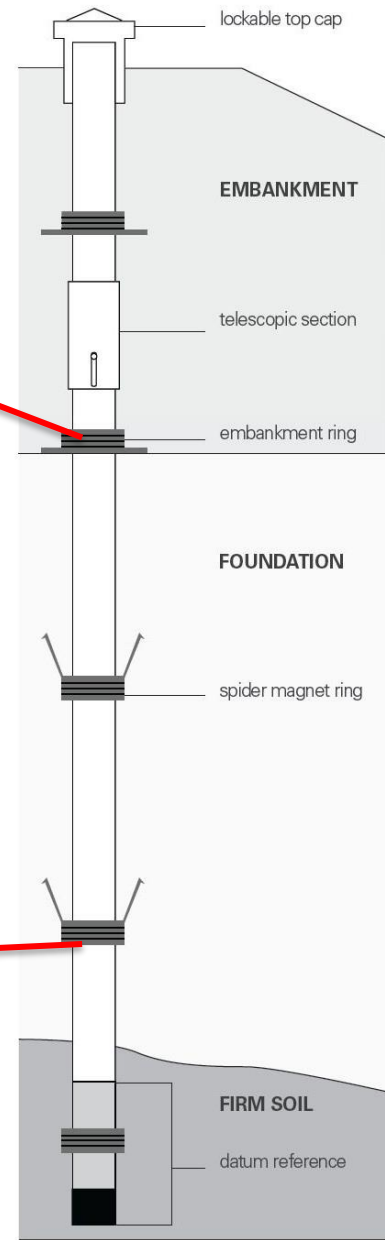

__ INCLINO-SETTLEMENT COLUMN

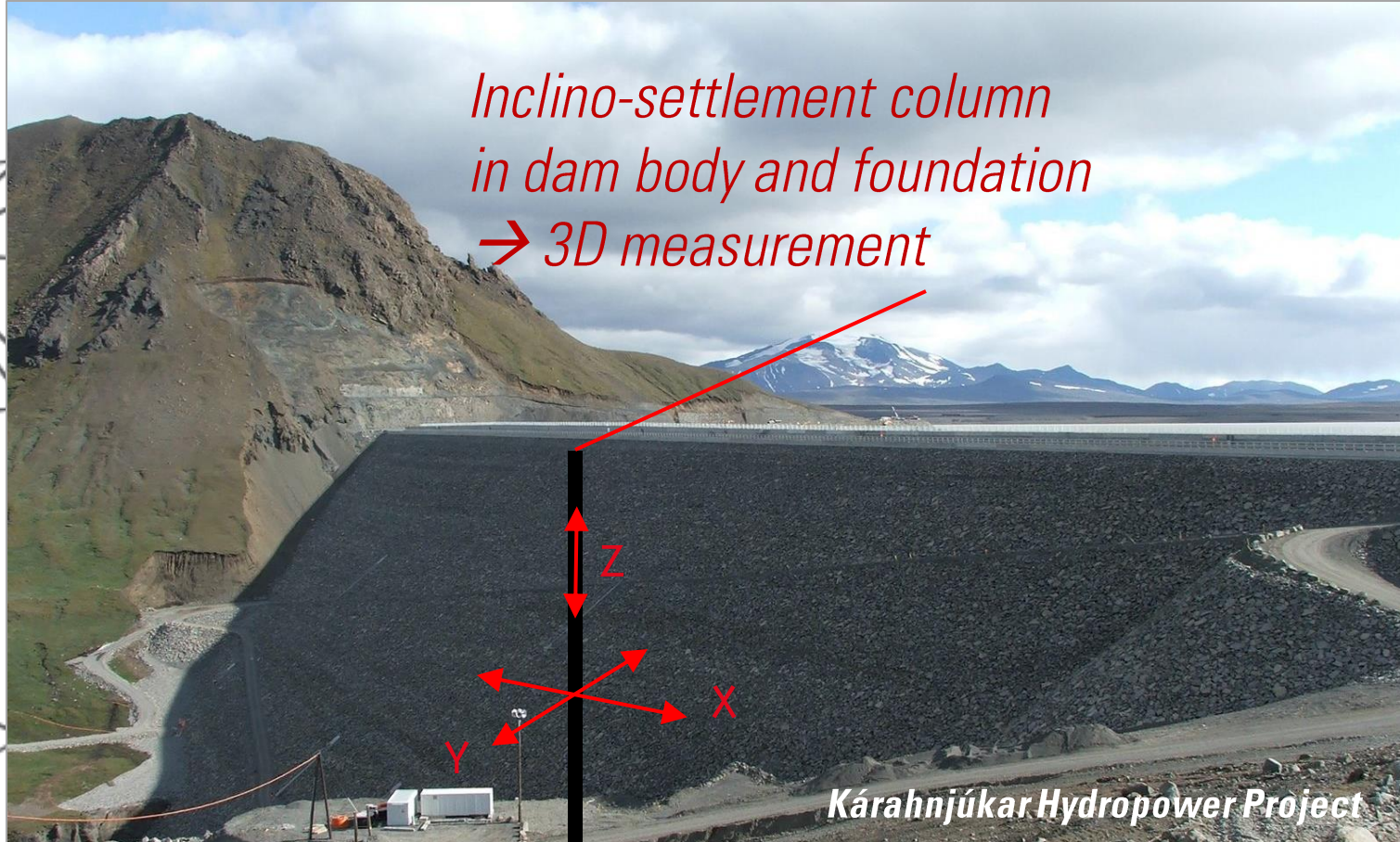

— INCLINO-SETTLEMENT COLUMN: INCLINOMETER SURVEY



— INCLINO-SETTLEMENT COLUMN: SETTLEMENT MEASUREMENT



CASAGRANDE PIEZOMETER

- Piezometer (pore pressure)
- ▽ Earth (total) pressure cell
- ⊕ Embankment extensometer
- ≡≡≡ Inclino-settlement column
- ⊏ Casagrande piezometer
- Water level meter
- ∇ Weir (flow meter)
- Survey point
- Strong motion accelerograph

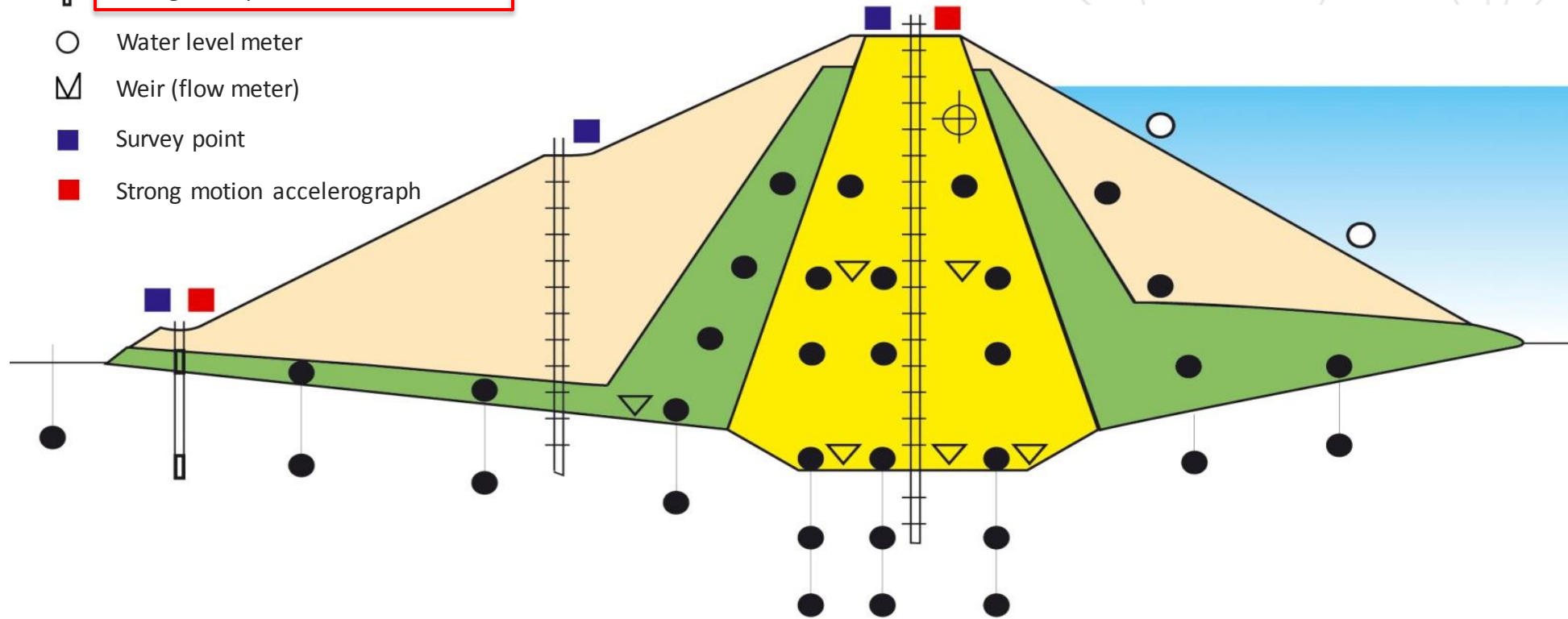

CASAGRANDE PIEZOMETER

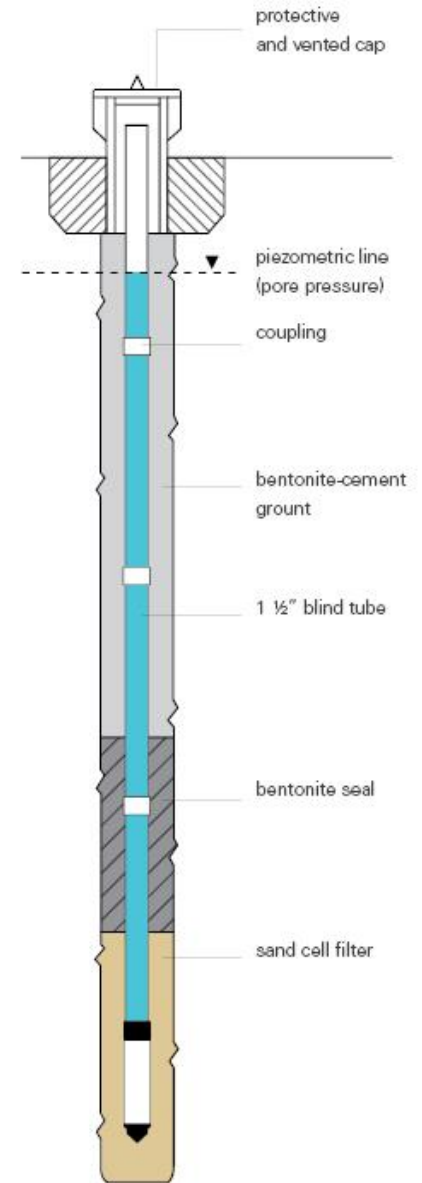

— WATER LEVEL METER

- Piezometer (pore pressure)
- ▽ Earth (total) pressure cell
- ⊕ Embankment extensometer
- ∥ Inclino-settlement column
- ∩ Casagrande piezometer
- Water level meter
- ∩ Weir (flow meter)
- Survey point
- Strong motion accelerograph

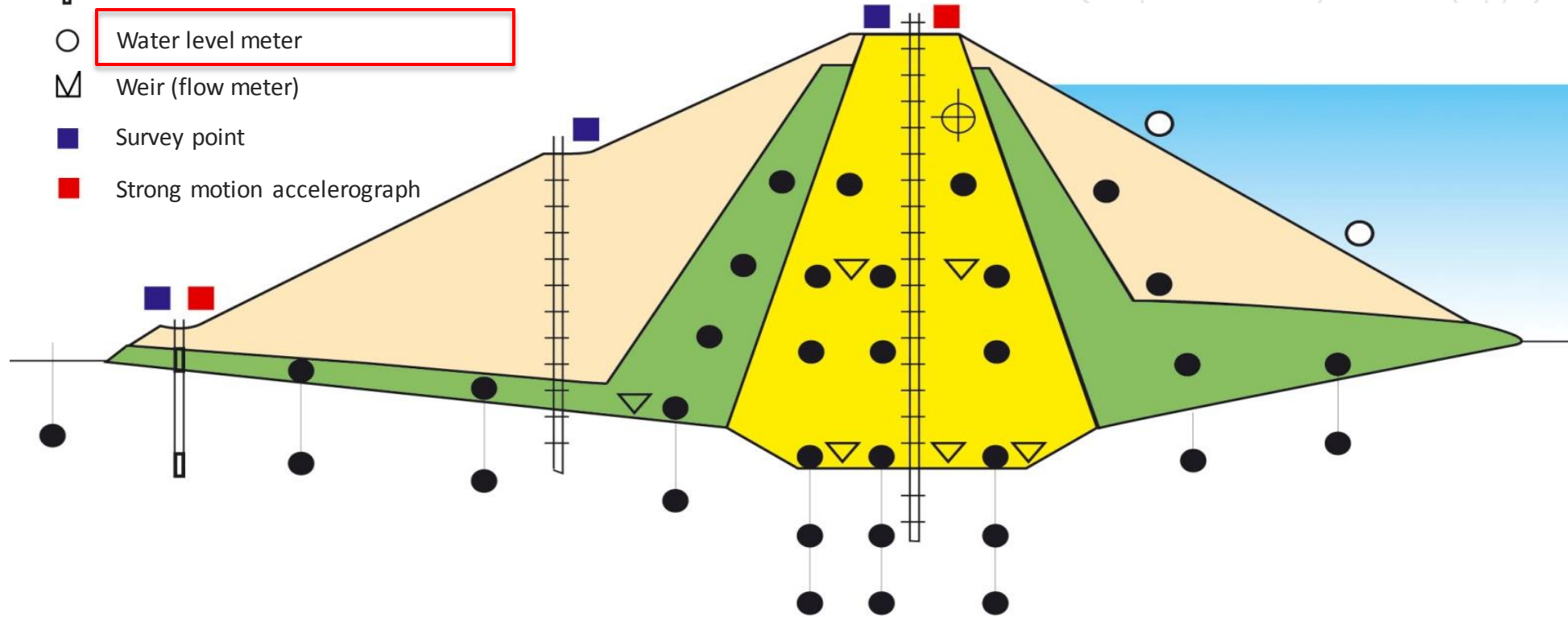

— WATER LEVEL METER



Relative pressure transducer



WEIR (FLOW) METER

- Piezometer (pore pressure)
- ▽ Earth (total) pressure cell
- ⊕ Embankment extensometer
- ∥ Inclino-settlement column
- ∩ Casagrande piezometer
- Water level meter
- ⊞ Weir (flow meter)
- Survey point
- Strong motion accelerograph

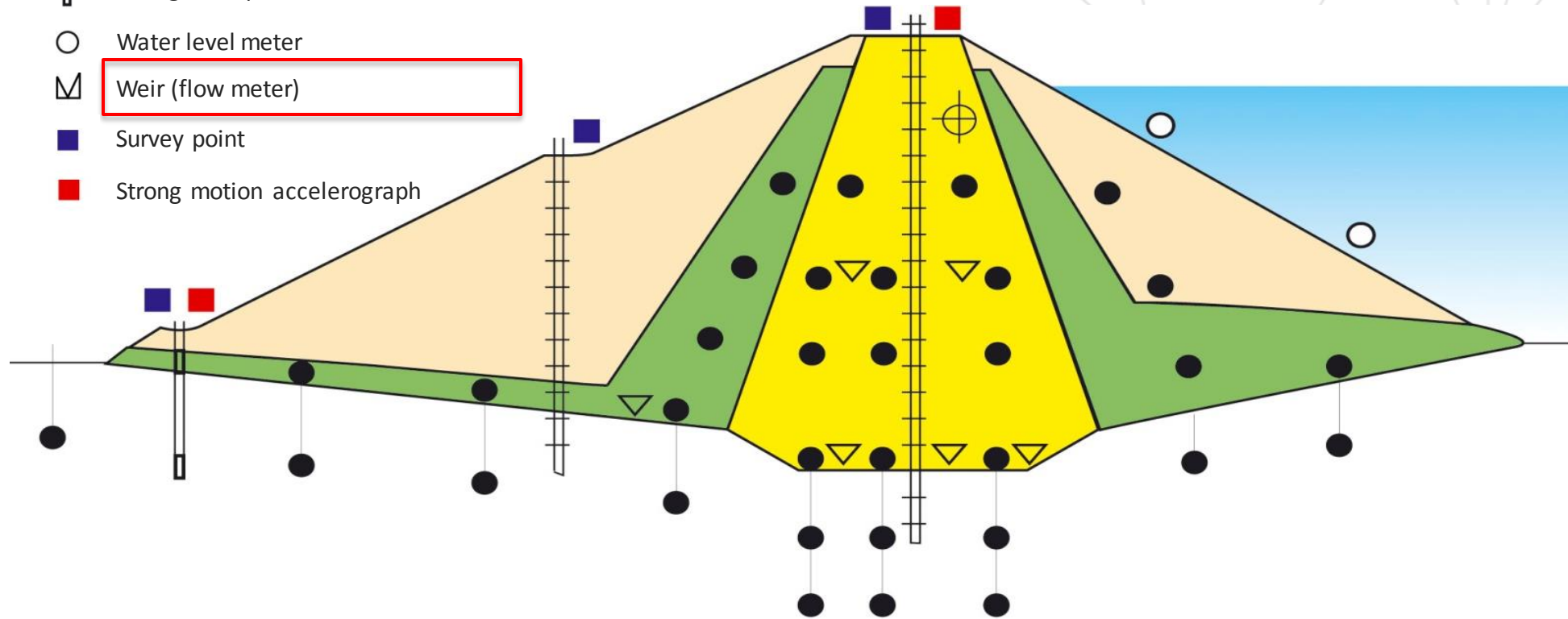

— WEIR-FLOW METERS – V-NOTCHES

Leakage measurement is one of the most important indicator of overall performance of dams

Leakage monitoring provides data for evaluation of dam long term stability



WEIR (FLOW) METERS – V-NOTCHES

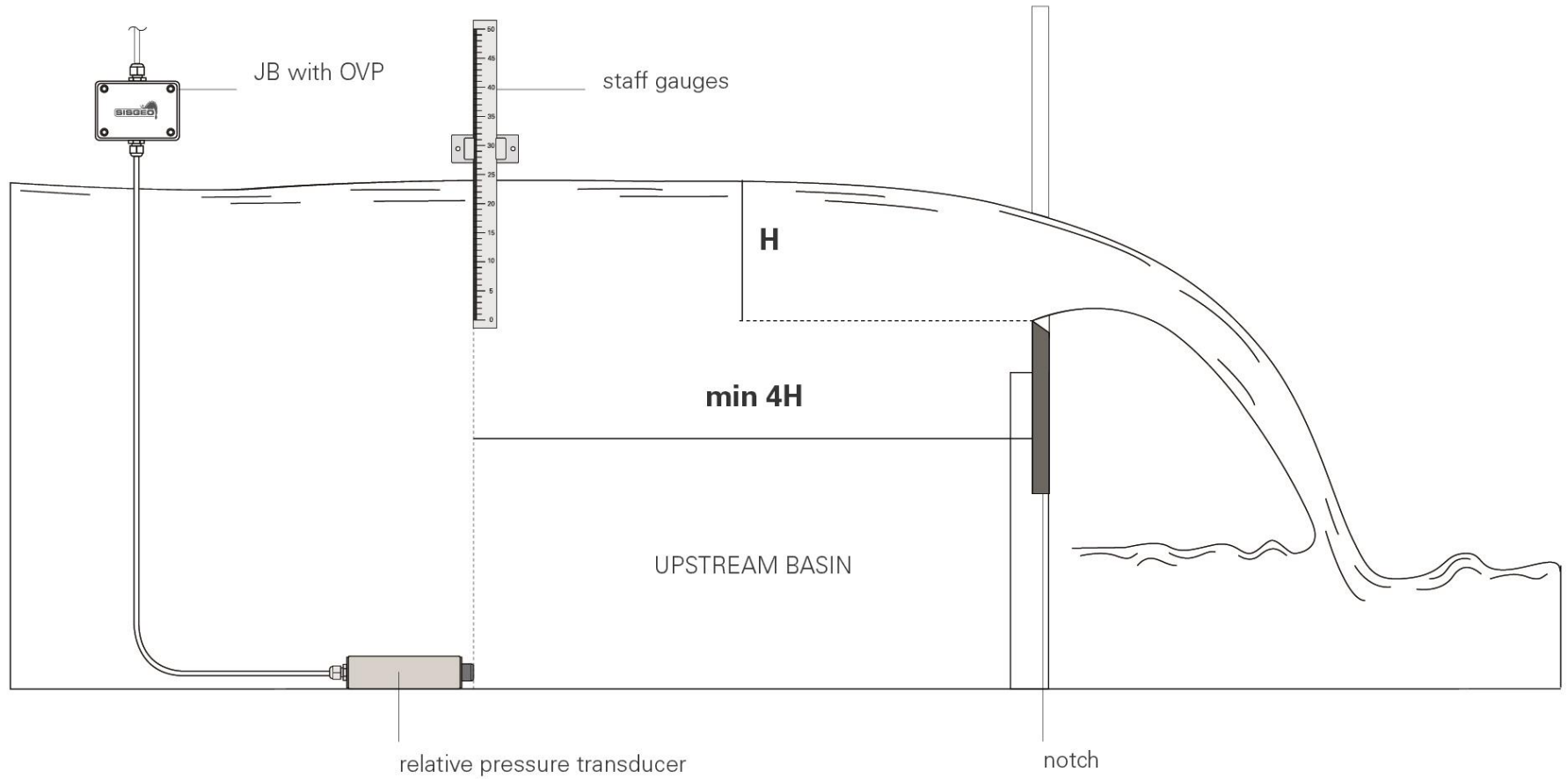

— SURVEY POINT

- Piezometer (pore pressure)
- ▽ Earth (total) pressure cell
- ⊕ Embankment extensometer
- ≡≡≡ Inclino-settlement column
- ⏏ Casagrande piezometer
- Water level meter
- ⌒ Weir (flow meter)
- Survey point
- Strong motion accelerograph

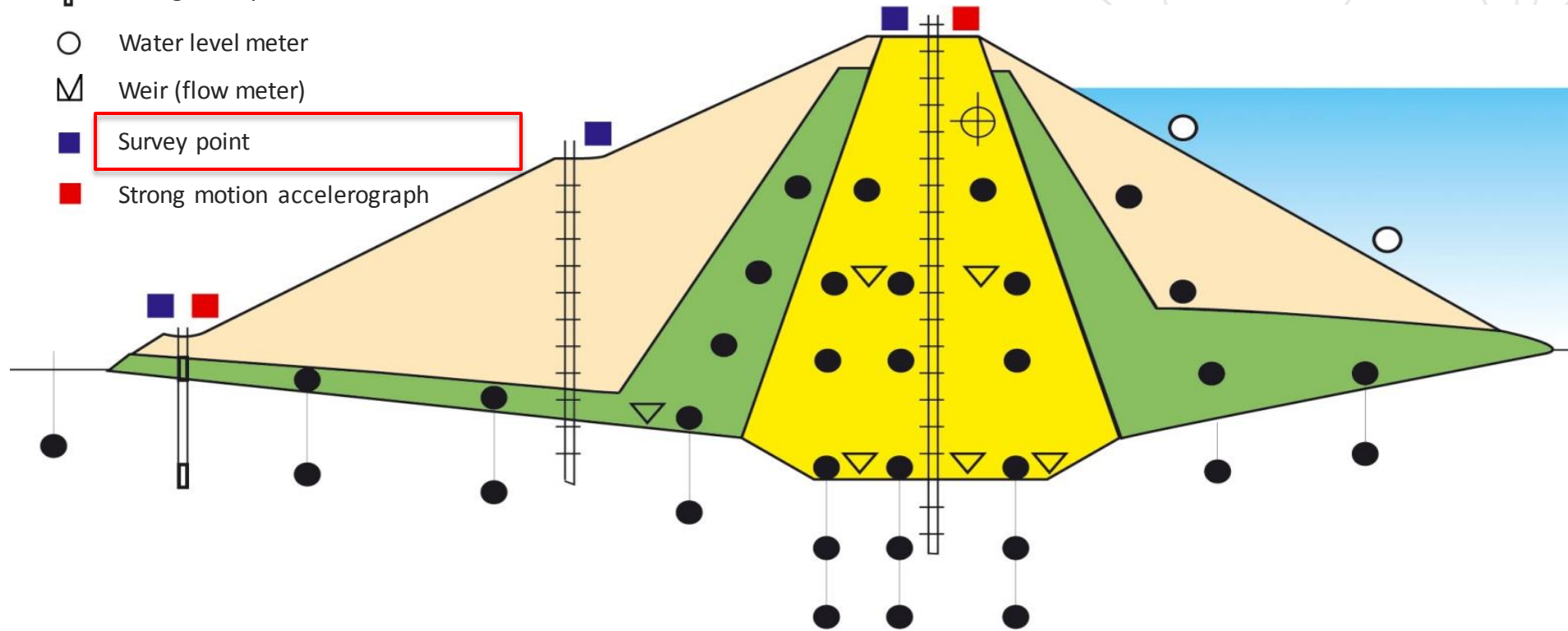

— SURVEY POINTS (BENCHMARKS, PRISMS, ETC...)



— SURVEY POINT

- Piezometer (pore pressure)
- ▽ Earth (total) pressure cell
- ⊕ Embankment extensometer
- ≡≡≡ Inclino-settlement column
- ⏏ Casagrande piezometer
- Water level meter
- ∇ Weir (flow meter)
- Survey point
- Strong motion accelerograph

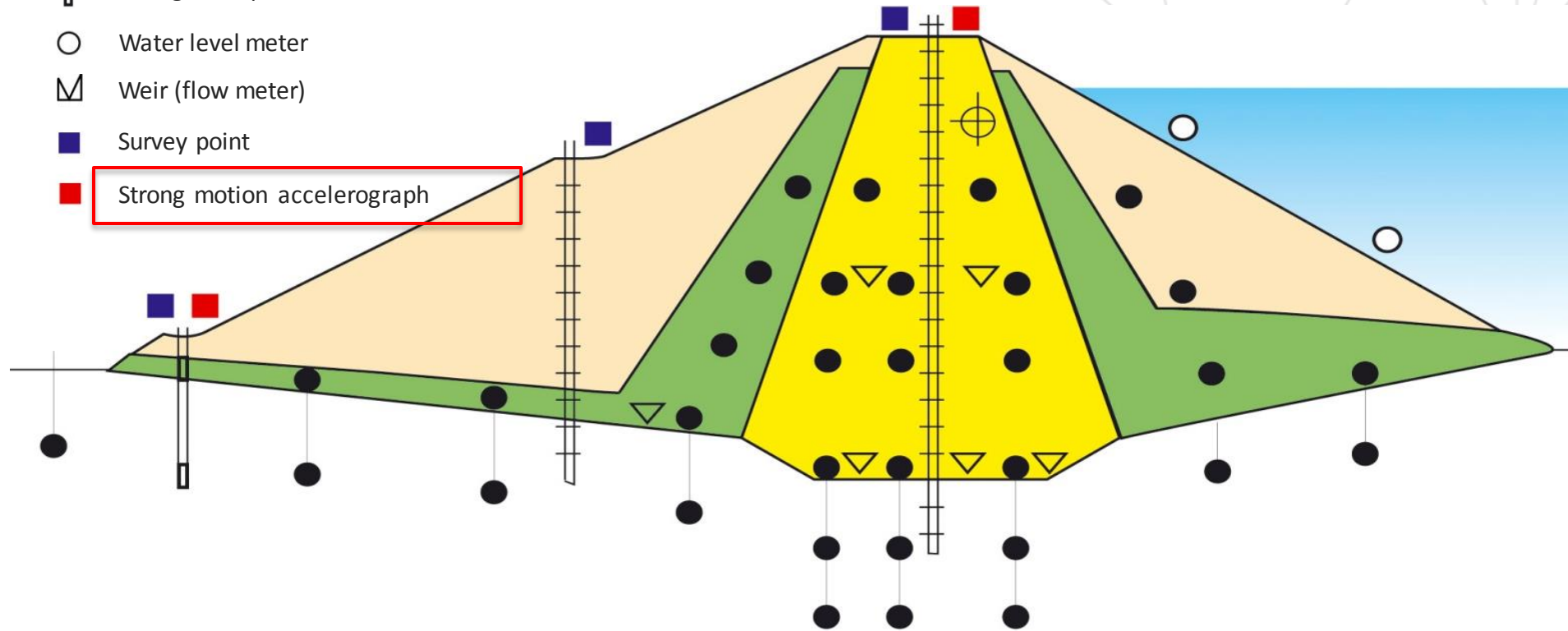

— STRONG MOTION ACCELEROGRAPH



— DAM MONITORING: DATA ACQUISITION SYSTEM

Instruments installed in the dam body provide automatic real-time monitoring by means of OMNIAlog datalogger.

With an internet 3G router, OMNIAlog can provide remote system management, data pushing on a server and alarms.



Wadi Daiqa DAM, OMAN

__ DAM MONITORING: DATA ACQUISITION SYSTEM



OMNIAlog Module

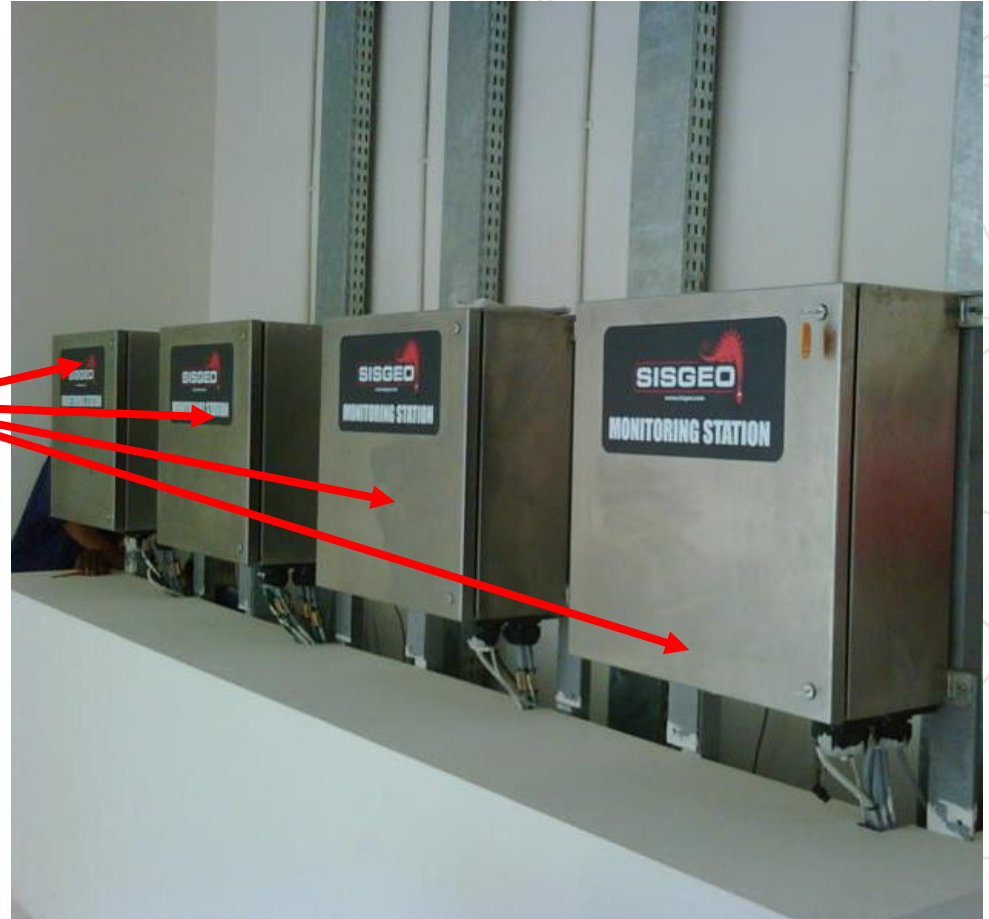

Wadi Daiqa DAM, OMAN

— DAM MONITORING: DATA ACQUISITION SYSTEM



Wadi Daiqa DAM, OMAN

— METEOROLOGICAL STATION



Typical meteorological parameters needed in dam monitoring include:

- *rain fall*
- *wind speed and direction*
- *atmospheric pressure*
- *air temperature and humidity*
- *evaporation*



THANKS FOR WATCHING

*For any further clarification
visit www.sisgeo.com
or email us: info@sisgeo.com*



THANKS FOR WATCHING

*For any further clarification
visit www.sisgeo.com
or email us: info@sisgeo.com*