

L140

EARTH
PRESSURE CELLS

PRESSURE
& LOAD CELLS

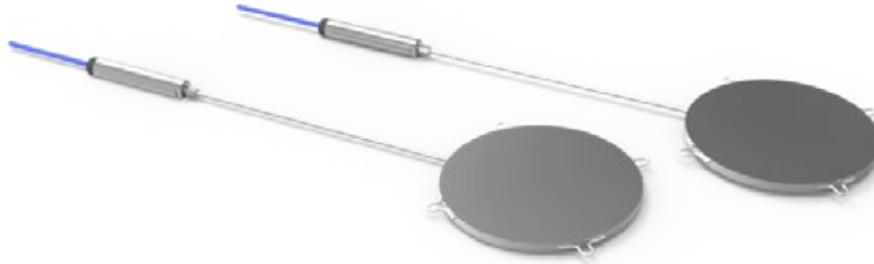



EARTH PRESSURE CELLS

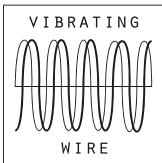

Earth pressure cells are designed to monitor total pressure in earthfill dams, embankments, and at the interface between structures and soil.

Pressure applied to the surface of the pressure cell is transmitted hydraulically to a pressure transducer which can be read with a portable readout or a data logger.

APPLICATIONS

- Embankments
- Retaining walls
- Diaphragm walls

FEATURES

- High-tech transducer offers reliability, fast response, and long-term stability.
- High accuracy and resolution
- Stainless steel construction, hermetically sealed
- One-side sensitive pad
- Output signal suitable for long distance transmission

CE *Meet the essential requirements of the EMC Directive 2014/30/UE*

TRANSDUCERS SPECIFICATIONS

	L143 MODEL
Description	VW pressure transducer
Full scales (FS)	0-350 kPa up to 0-10.0 MPa 0-50 psi up to 0-1450 psi
Sensitivity	0.03% FS
Temperature sensor	built-in thermistor
Overload	100% FS
Pol. MPE ⁽¹⁾	< ±0.25% FS (< ±0.1% FS on request)
Electrical supply	-
Typical frequency range ⁽²⁾	2250 - 3000 Hz
Output signal	frequency
Operating temperature range	-20°C +80°C
Transducer size	OD 27mm, 180mm long OD 1", 7.1" long
Material / weight	stainless steel / 0.6 kg
Cables	0WE104K00ZH LSZH cable 0WE104X20ZH LSZH armoured cable
Max cable length to logger ⁽³⁾	1000 m (for more information see FAQ#77)

(1) MPE is the Maximum Permitted Error on the measuring range (FSR). In the Calibration Report, the accuracies of the gauge are calculated using both linear regression (≤ Lin. MPE) and polynomial correction (≤ Pol. MPE)

(2) The expressed frequency may vary +/-10% (3) Refer to FAQ section of Sisgeo website: www.sisgeo.com/faq

PRESSURE PAD

Material	Stainless steel
Total weight	4.5 Kg (9.9 lbs)
Hydraulic line	6 mm OD (0.25" OD), stainless steel tube

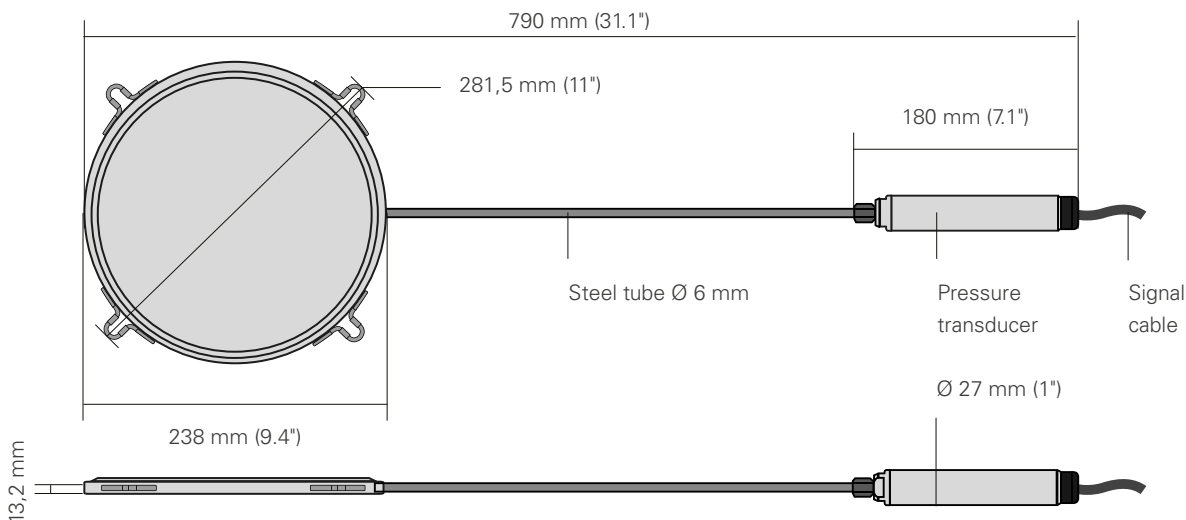

ACCESSORIES AND SPARE PARTS

2-WIRE SIGNAL CABLE OWE102KE0ZH

Two conductor, LSZH cable (20 AWG) with Kevlar stress member for 4-20mA pressure cells. Cables are factory fitted to the electrical transducer during manufacture.

4-WIRES ARMoured SIGNAL CABLE OWE104X20ZH

Four conductor, LSZH cable (22 AWG) armoured with stainless steel wire. Cables are factory fitted to the electrical transducer during manufacture.

SWITCH TERMINAL JB OEPC0000S00

Available in different sizes to connect up to 6,12,18 or 24 instruments. Equipped with up to four 6-position rotary switches and connector for readout.

INSTALLATION PROCEDURES

In many cases, the soil to be investigated is not uniform: for a good installation of total pressure cells is important to prepare a hand-compacted sand bed for the pressure cells about 50 to 100 mm thick. Then, after placing the cell, cover it with thicker, 100 to 200 mm layer of hand-compacted sand



Landfill foundation in Milan area - Italy

READABLE BY

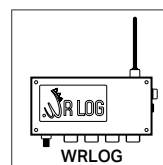
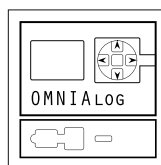
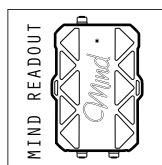
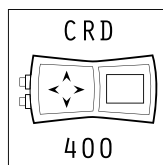

For further information refer to their own datasheets

All the information in this document is the property of Sisgeo S.r.l. and should not be used without permission from Sisgeo S.r.l. The manufacturer reserves the right to make changes to the product or to its parts without prior notice, also on the basis of contingent situations not related to the technical characteristics alone, such as, for example, material or components shortages. For the specific accuracy performance of each product, please refer to the Calibration Report issued for each instrument. The datasheet is issued in English and other languages. In order to avoid discrepancies and disagreement on the interpretation of the meanings, Sisgeo Srl declares that English Language prevails.

SISGEO S.R.L.

VIA F. SERPERO 4/F1
20060 MASATE (MI) ITALY
PHONE +39 02 95764130
FAX +39 02 95762011
INFO@SISGEO.COM

TECHNICAL ASSISTANCE

SISGEO offers customers e-mail and phone assistance to ensure proper use of instruments and readout and to maximize performance of the system.

For more information, email us: assistance@sisgeo.com